

HHx-Sicherungseinsätze

Hochspannungs-Hochleistungs-
Sicherungseinsätze, Sonderbauformen

HHx Fuse-Links

High-Voltage
Special Fuse-Links

Einleitung /
Introduction

Technische Daten nach Baureihen /
Technical Data Types of Fuses

HHx-Sicherungseinsätze

Hochspannungs-Hochleistungs-
Sicherungseinsätze / Sonderbauformen

HHx Fuse-Links

High-Voltage
Fuse-Links / Special Fuse-Links

Einleitung Introduction



Einsatzgebiete, Baureihen

Vorbemerkung

Mit den „Sonderbauformen“ fasst SIBA spezielle Konstruktionen für verschiedene Anforderungen im Bereich der Hochspannungs-Hochleistungssicherungen zusammen. Neben reinen Sonderfällen sind hier auch die nach Werksspezifika hergestellten Sicherungen zu finden.

Sicherungen für den Schutz ölisolierter Verteiltransformatoren

HHOZ-B (Seite 162ff)

Der Einbau von Hochspannungs-Sicherungseinsätzen in ölisierten Verteiltransformatoren bietet für das Gesamtkonzept von Ortsnetzstationen Platz- und Kostenersparnis.

Die Sicherungseinsätze erfüllen alle Anforderungen hinsichtlich Dichtigkeit unter Öl sowohl während der Herstellungsphase des Transformators als auch im Dauerbetrieb.

Zur Montage im Transformator sind die Sicherungseinsätze an den Anschlusskappen mit M8-Gewindebuchsen versehen.

Durch einen besonderen Aufbau des alterungsbeständigen Schmelzleitersystems, durch die Verwendung hochwertiger Keramik des Isolierrohres sowie durch geeignete Abdichtungsmaßnahmen können die Sicherungseinsätze wartungsfrei im Transformator-kessel verbleiben. Die Teilbereichs-Sicherung der Baureihe HHOZ-B ist erhältlich für die Bemessungsspannungsbereiche 12 kV, 24 kV und 36 kV.

HHOD-B (Seite 168f)

Auch diese Teilbereichs-Sicherung ist für den Einsatz unter Öl konzipiert, ist aber von Abmessungen bzw. Bauform her als DIN-Sicherung ausgelegt.

Die Sicherung ist erhältlich im Bemessungsspannungsbereich 24 kV.

Application range, types

Preliminary note

Using this category SIBA summarizes the special constructions of fuse-links for different requirements within the field of high-voltage fuses. Beneath clear specific cases here those fuses are to be found, which are made based on SIBA-own standards.

Fuses for the protection of oil insulated main transformers

HHOZ-B (page 162ff)

The installation of high-voltage fuse-links inside oil filled transformers provides space and cost savings in the total concept of distribution transformer substations.

The fuse-links fulfill all requirements regarding oiltightness during the manufacturing phase of the transformer itself and also during service operation.

The fuse-links are provided with threaded holes size M8 at their contact caps for easy installation inside the transformer.

The fuse is age resistant, owing to the specific design of the fuse element and the use of high grade ceramic as well as appropriate sealing methods. These fuse-links can be used inside oil filled transformers free of any ageing for many decades.

These back-up fuses are available for the following range of rated voltage: 12 kV, 24 kV and 36 kV.

HHOD-B (page 168f)

These back-up fuses, too, are designed for the use under oil within the transformer. It is constructed as a DIN-fuse, concerning measures and shape.

This fuse is available for a rated voltage of 24 kV.

HHOZ-G (Seite 170ff)

Die Sicherungen dieser Baureihe sind Vielbereichssicherungen für den Einsatz unter Öl im Transformator. Durch den Einsatz dieser Sicherungen wird ein größtmöglicher Bereich aller in Frage kommenden Fehlerströme erkannt und abgeschaltet. Über den üblichen Berstschutz hinaus werden auch niedrige Überströme in Folge von Windungs- oder Erdschlüssen schnell unterbrochen.

HHOZ-G-Sicherungen bieten wir in den Bemessungsspannungsbereichen 12 kV, 17,5 kV und 24 kV an.

HHOZ-G (page 170ff)

These fuses, designed as general purpose fuses, provide superior protection inside the so called "Intrinsically Safe Transformers". For this purpose, the high-voltage fuses are designed as general purpose fuses. The fuses will provide detection and cut-off of a widest possible range of fault currents. As well as the desired protection of transformer tanks against bursting, they also interrupt. We offer HHOZ-G fuse-links for Rated Voltage ranges of 12 kV, 17,5 kV and 24 kV.

Sicherungen für Freileitungsmontage

HHP-B (Seite 178f)

Mittelspannungssicherungen werden im Set geliefert. Sie ermöglichen in Freileitungen Sicherungsschutz von mastmontierten Verteiltransformatoren. Das Set besteht aus drei Hochspannungssicherungseinsätzen und einem Satz aus Kontaktarmaturen.

Ein auf der Basis dieses Sets installierter Leitungsabzweig bietet die Möglichkeit einer mittelspannungsseitigen Trennung des Transformators vom Netz. Da die Trennung unter Spannung erfolgen kann, bleibt die Freileitung während der Wartungs- und Änderungsarbeiten in Betrieb.

Die Hochspannungssicherungen sind für den Berstschutz des Transformators vorgesehen. Das Zeit/Strom-Verhalten der Sicherungen ist auf die maximale Stehzeit der üblichen Masttransformatoren im Fehlerfall abgestimmt. Durch entsprechende Auslegung der Schmelzleiter sind die Sicherungen besonders in gewitteraktiven Gebieten zu verwenden, da die sehr kurzen Stromspitzen nicht zu einer Abschaltung führen können.

Die Sicherungen mit einem Bemessungswert von 24 kV sind in Netzen von 10 bis 20 kV einzusetzen.

Fuses with overhead line connectors

HHP-B (page 178f)

Medium-voltage fuses come in a set. On overhead lines they provide fuse protection for pole mounted distribution transformers. The set consists of three high-voltage fuse-links and a set of contacting armatures.

A tee-off connection installed on the basis of such a set makes it possible to isolate the transformer on the medium-voltage side from the service line. Because isolation can be achieved with the overhead line alive, service and modification work can be performed without interrupting the power supply.

The high-voltage fuses are designed to provide bursting protection for the transformer. The time-current characteristic of the fuses corresponds to the maximum withstand capability of standard pole mounted transformers under fault conditions. The special design of the fuse-link melting elements makes them especially suitable for overhead lines in thunderstorm-prone areas, because the short current peaks of lightning strikes will not cause the fuses to break. The fuses with a rated voltage 24 kV are suitable for networks with service voltages from 10 kV to 24 kV.

Von besonderem Vorteil zur Verwendung im Freileitungsbau ist das niedrige Gewicht der einzelnen Komponenten durch die Verwendung von Aluminium für die Kontaktarmaturen und Kunststoff als Werkstoff für das Isolierrohr der Sicherung.

An outstanding advantage for installation work on overhead lines is the low weight of the fuse and connectors, which is achieved by using aluminium for the contact armatures and polyester for the housing of the fuse.

Sicherungen für den Schutz von Spannungswandlern

HHZ-BVT (Seite 180ff)

SIBA HHZ-BVT-Sicherungen für den Schutz von Spannungswandlerringen sind Teilbereichssicherungen und demnach zur Unterbrechung von Kurzschlussströmen vorgesehen. Auf Grund ihrer hohen Strombegrenzungseigenschaft isolieren sie den fehlerhaften Spannungswandler in wenigen Millisekunden vom Netz.

Die Sicherungen werden mit Schlagstift bevorzugt in den Bemessungsstromstärken 2 A, 3,15 A und 4 A angeboten.

Sicherungen in zylindrischer Bauform (HHZ-BVT) sind im Durchmesser 22 mm, 24 mm und 39,6 mm erhältlich. Die verfügbaren Bemessungsspannungen sind auch hier 3/7,2 kV, 6/12 kV, 10/17,5 kV, 10/24 kV und 20/36 kV bei Bemessungsströmen von 1 A bis 5 A. Die Sicherungslängen sind den jeweiligen Bemessungsspannungen angepasst.

Erstes Auswahlkriterium ist die Betriebsspannung. Die Bemessungsspannung des Sicherungseinsatzes muss größer als die Betriebsspannung sein.

Der Laststrom des Spannungswandlers ist üblicherweise relativ niedriger und beträgt meist nur wenige 100 mA. Die Sicherung ist deshalb auf die höchst zu erwartenden transienten Ströme auszulegen. Diese Ströme sollten im Kennlinienraster der Sicherungen angetragen werden, und zwischen den angetragenen Punkten und der ausgewählten Sicherungskennlinie sollte ein Selektivitätsabstand von 1:2 eingehalten werden.

Fuses for the protection of voltage transformer circuits

HHZ-BVT (page 180ff)

SIBA HHZ-BVT fuses for the protection of voltage transformer (VT) circuits are designed as back-up fuses for interrupting short-circuit currents. Due to their high current-limiting capacity, faulty voltage transformers are isolated from the grid in a matter of milliseconds. The fuses, which feature a striker pin, are on offer for rated currents of 2 A, 3.15 A and 4 A.

Cylindrical versions of fuses (HHZ-BVT) are available with a diameter of 22 mm, 24 mm and 39.6 mm for rated voltages of 3/7.2 kV, 6/12 kV, 10/17.5 kV, 10/24 kV and 20/36 kV and correspond to rated currents between 1 A and 5 A. The fuse lengths are matched to the relevant rated voltage.

The first criteria for selection is the operating voltage. The rated voltage of the fuse-link must exceed the operating voltage of the system.

Under normal conditions, the VT's load current is relatively lower and amounts to several 100 mA only. The fuse must therefore be selected to withstand worst-case transients. These currents should be marked in the characteristic diagram of the fuses, whereby a discrimination safety margin of 1:2 is recommended between the points marked and the selected fuse characteristic.

12 kV

L1 = 360 mm

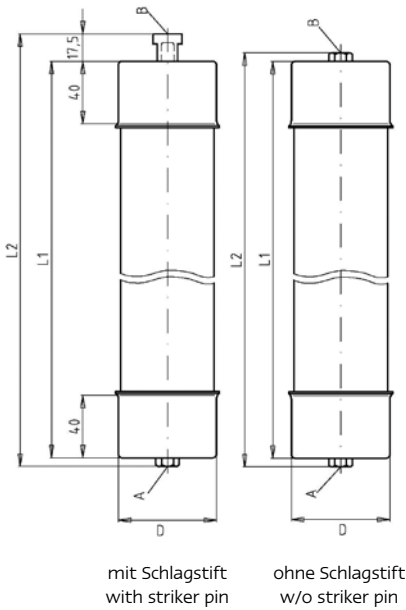

mit Schlagstift
with striker pin

ohne Schlagstift
w/o striker pin

Vorzugsabmessung / Standard dimension

Beidseitiges Innengewinde / Both ends female thread
Ohne Schlagstift / Without striker pin
Mit Schlagstift / With striker pin

Einsatz / Application

Einbau in den Öl-Transformator / Oil-transformer application

Verpackung / Packing 1 Stück / 1 piece

Betriebsklasse / Class
Teilbereich / Back-up

IEC 60282-1

Bemessungs- spannung Rated Voltage	Artikel Article	Gewinde Thread		Bemessungsstrom Rated Current	Länge Length		Durchmesser D Diameter D
		A	B		L1	L2	
kV				A	mm	mm	mm
12	30 310 11	M8	M8	6,3 - 125	360	371	63,5
	30 310 16	M8	G1/8"		360	383	

Bemessungs- strom Rated Current	Artikel Nr. Article No.		Gewicht Weight	Bemessungs- ausschaltstrom Rated Breaking Current - I ₁	Minimaler Ausschaltstrom Min. Breaking Current - I ₃	Schmelzintegral Pre-Arcing-I ² t- Value	Ausschalt- integral Total I ² t-Value	Leistungs- abgabe Power Loss
	o. Schlagstift w/o striker pin	m. Schlagstift striker pin						
A			kg/1	kA	A	A ² s	A ² s	W
6,3	30 310 11.6,3	30 310 16.6,3	2,6	63	22	45	360	16
10	30 310 11.10	30 310 16.10	2,6	63	34	75	560	28
16	30 310 11.16	30 310 16.16	2,6	63	56	250	2.000	28
20	30 310 11.20	30 310 16.20	2,6	63	70	640	4.800	23
25	30 310 11.25	30 310 16.25	2,6	63	90	1.050	7.500	29
31,5	30 310 11.31,5	30 310 16.31,5	2,6	63	110	1.700	12.000	38
40	30 310 11.40	30 310 16.40	2,6	63	140	2.900	19.000	50
50	30 310 11.50	30 310 16.50	2,6	63	170	5.700	33.000	56
63	30 310 11.63	30 310 16.63	2,6	63	210	10.700	66.000	63
80	30 310 11.80	30 310 16.80	2,6	63	280	17.500	175.000	120
100	30 310 11.100	30 310 16.100	2,6	63	350	41.500	415.000	136
125	30 310 11.125	30 310 16.125	2,6	63	438	56.500	565.000	181

12 kV

L1 = 360 mm



Zeit/Strom-Kennlinie
Time-current characteristic

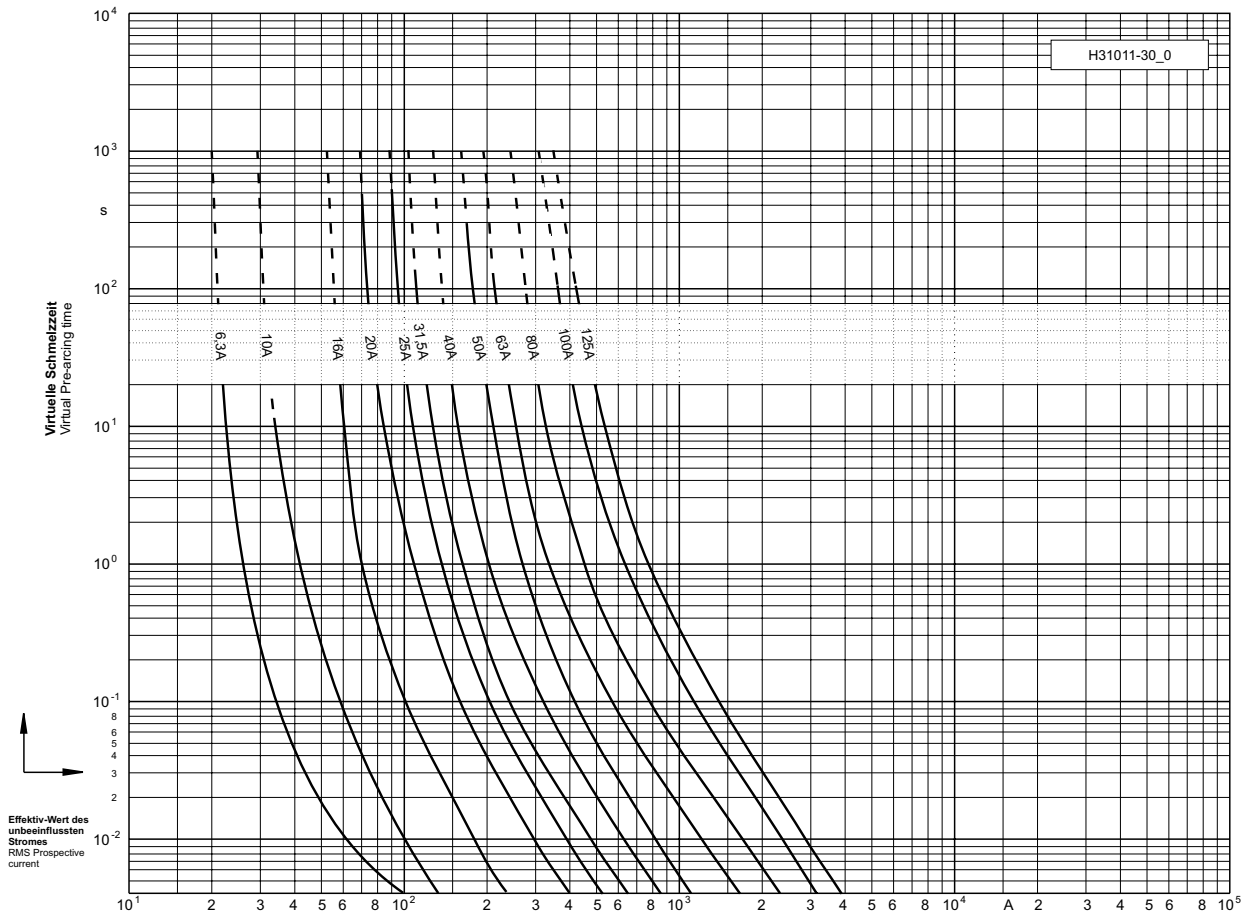

Durchlass-Strom
Cut-off current

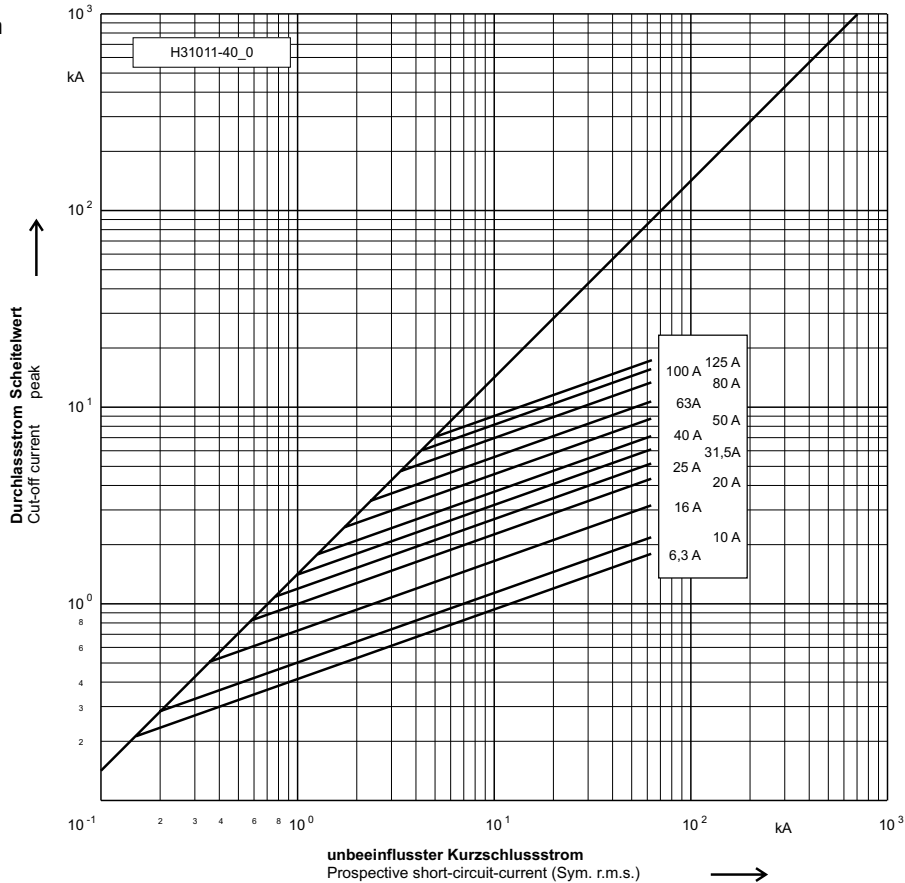

24 kV

L1 = 360 mm

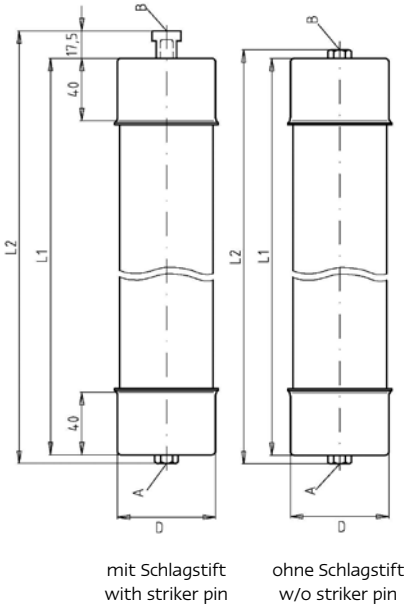

mit Schlagstift
with striker pin

ohne Schlagstift
w/o striker pin

Beidseitiges Innengewinde / Both ends female thread
Ohne Schlagstift / Without striker pin
Mit Schlagstift / With striker pin

Einsatz / Application

Einbau in den Oil-Transformator / Oil-transformer application

Verpackung / Packing 1 Stück / 1 piece

Betriebsklasse / Class	IEC 60282-1
Teilbereich / Back-up	

Bemessungs- spannung Rated Voltage	Artikel Article	Gewinde Thread		Bemessungsstrom Rated Current	Länge Length		Durchmesser D Diameter D
		A	B		L1	L2	
kV				A	mm	mm	mm
24	30 312 11	M8	M8	6,3 - 80	360	371	63,5
	30 312 15	M8	-	6,3 - 80	360	365	
	30 312 16	M8	G1/8"	6,3 - 80	360	383	

Bemessungs- strom Rated Current	Artikel Nr. Article No.			Gewicht Weight	Bemessungs- ausschaltstrom Rated Breaking Current - I ₁	Minimaler Ausschaltstrom Min. Breaking Current - I ₃	Schmelz- integral Pre-Arcing- I ² t-Value	Ausschalt- integral Total I ² t- Value	Leistungs- abgabe Power Loss
	o. Schlagstift w/o striker pin	m. Schlagstift striker pin	m. Schlagstift striker pin						
A				kg/1	kA	A	A ² s	A ² s	W
6,3	30 312 11.6,3	30 312 15.6,3	30 312 16.6,3	2,6	63	25	30	160	30
10	30 312 11.10	30 312 15.10	30 312 16.10	2,6	63	35	70	400	54
16	30 312 11.16	30 312 15.16	30 312 16.16	2,6	63	56	120	1.200	61
20	30 312 11.20	30 312 15.20	30 312 16.20	2,6	63	70	550	5.500	28
25	30 312 11.25	30 312 15.25	30 312 16.25	2,6	63	95	920	9.200	58
31,5	30 312 11.31,5	30 312 15.31,5	30 312 16.31,5	2,6	63	120	1.400	14.000	76
40	30 312 11.40	30 312 15.40	30 312 16.40	2,6	63	140	2.200	22.000	94
50	30 312 11.50	30 312 15.50	30 312 16.50	2,6	63	180	4.700	47.000	108
63	30 312 11.63	30 312 15.63	30 312 16.63	2,6	63	220	8.700	87.000	114
80	30 312 11.80	30 312 15.80	30 312 16.80	2,6	63	300	15.500	150.000	176

24 kV

L1 = 360 mm



Zeit/Strom-Kennlinie
Time-current characteristic

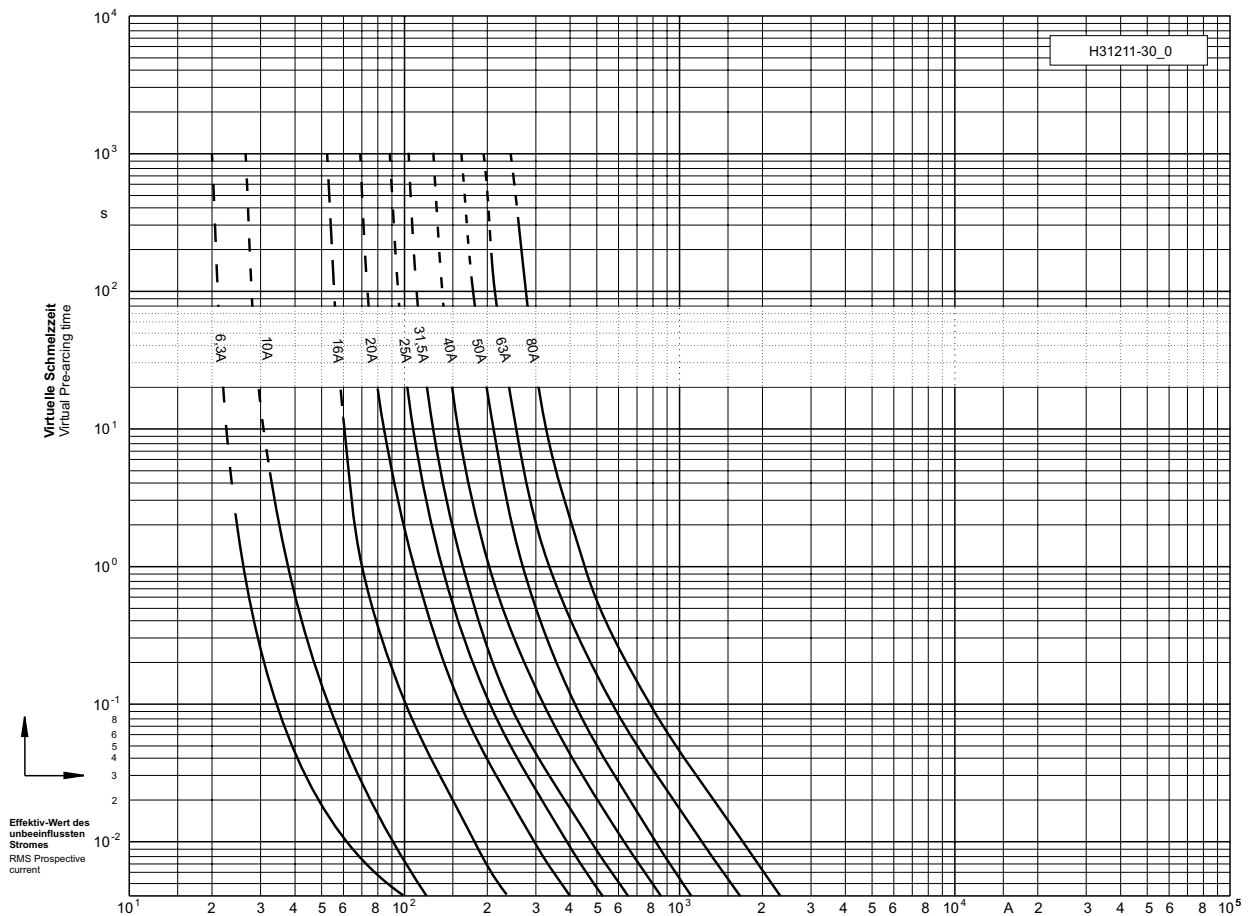

Durchlass-Strom
Cut-off current

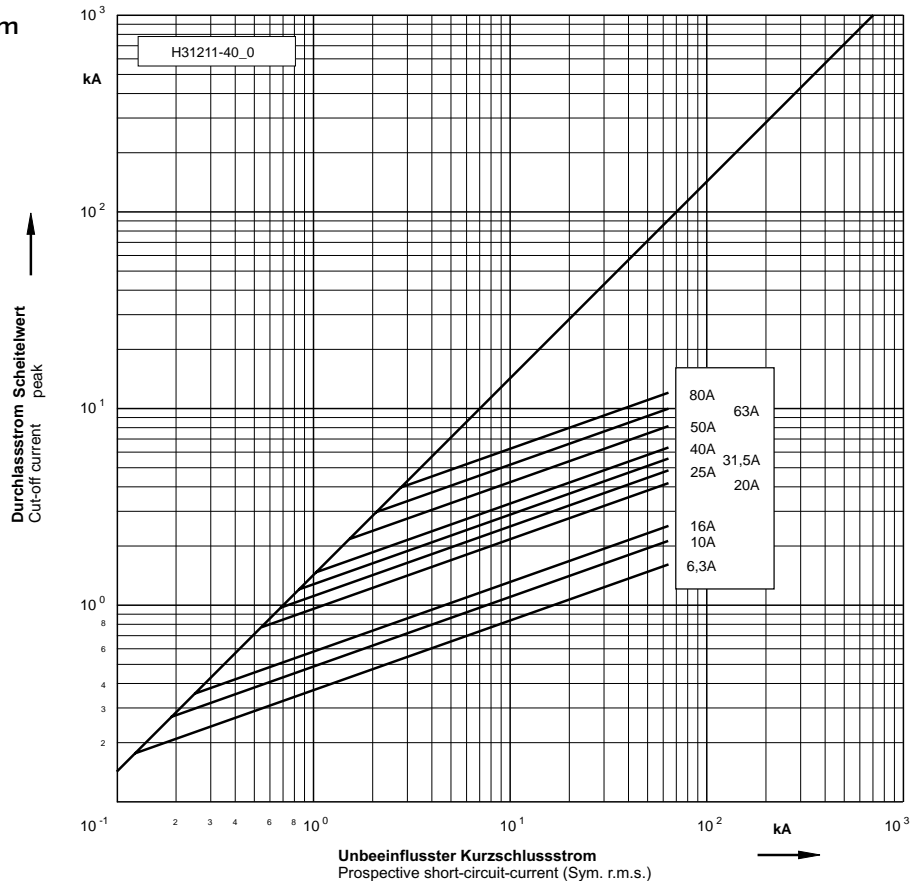

36 kV

L1 = 360 mm / 440 mm

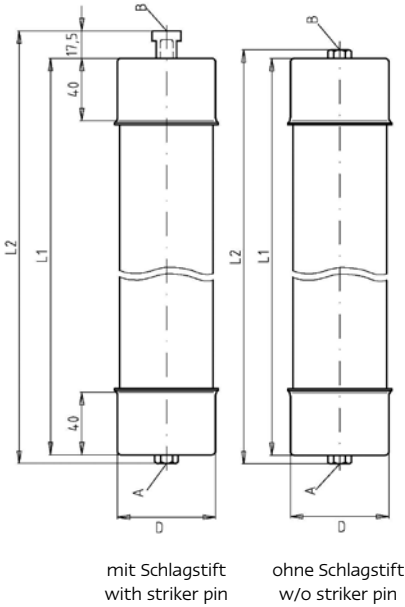

Vorzugsabmessung / Standard dimension

Beidseitiges Innengewinde / Both ends female thread
Ohne Schlagstift / Without striker pin
Mit Schlagstift / With striker pin

Einsatz / Application

Einbau in den Öl-Transformator / Oil-transformer application

Verpackung / Packing 1 Stück / 1 piece

Betriebsklasse / Class	IEC 60282-1
Teilbereich / Back-up	

Bemessungs- spannung Rated Voltage	Artikel Article	Gewinde Thread		Bemessungsstrom Rated Current	Länge Length		Durchmesser D Diameter D
		A	B		L1	L2	
kV				A	mm	mm	mm
36	30 323 11	M8	M8	10 - 25	360	371	63,5
	30 324 11	M8	M8	31,5 - 40	440	451	
	30 323 16	M8	G1/8"	10 - 25	360	383	
	30 324 16	M8	G1/8"	31,5 - 40	440	463	

Bemessungs- strom Rated Current	Artikel Nr. Article No.		Gewicht Weight	Bemessungs- ausschaltstrom Rated Breaking Current - I ₁	Minimaler Ausschaltstrom Min. Breaking Current - I ₃	Schmelzintegral Pre-Arcing-I ² t- Value	Ausschaltintegral Total I ² t-Value	Leistungs- abgabe Power Loss
	o. Schlagstift w/o striker pin	m. Schlagstift striker pin						
A			kg/1	kA	A	A ² s	A ² s	W
10	30 323 11.10	30 323 16.10	2,6	40	30	70	1.100	85
16	30 323 11.16	30 323 16.16	2,6	40	60	160	1.900	50
20	30 323 11.20	30 323 16.20	2,6	40	80	550	6.600	73
25	30 323 11.25	30 323 16.25	2,6	40	100	920	11.000	88
31,5	30 324 11.31,5	30 324 16.31,5	3,6	40	130	1.400	16.800	132
40	30 324 11.40	30 324 16.40	3,6	40	160	2.640	31.700	155



36 kV

L1 = 360 mm / 440 mm

Zeit/Strom-Kennlinie
Time-current characteristic

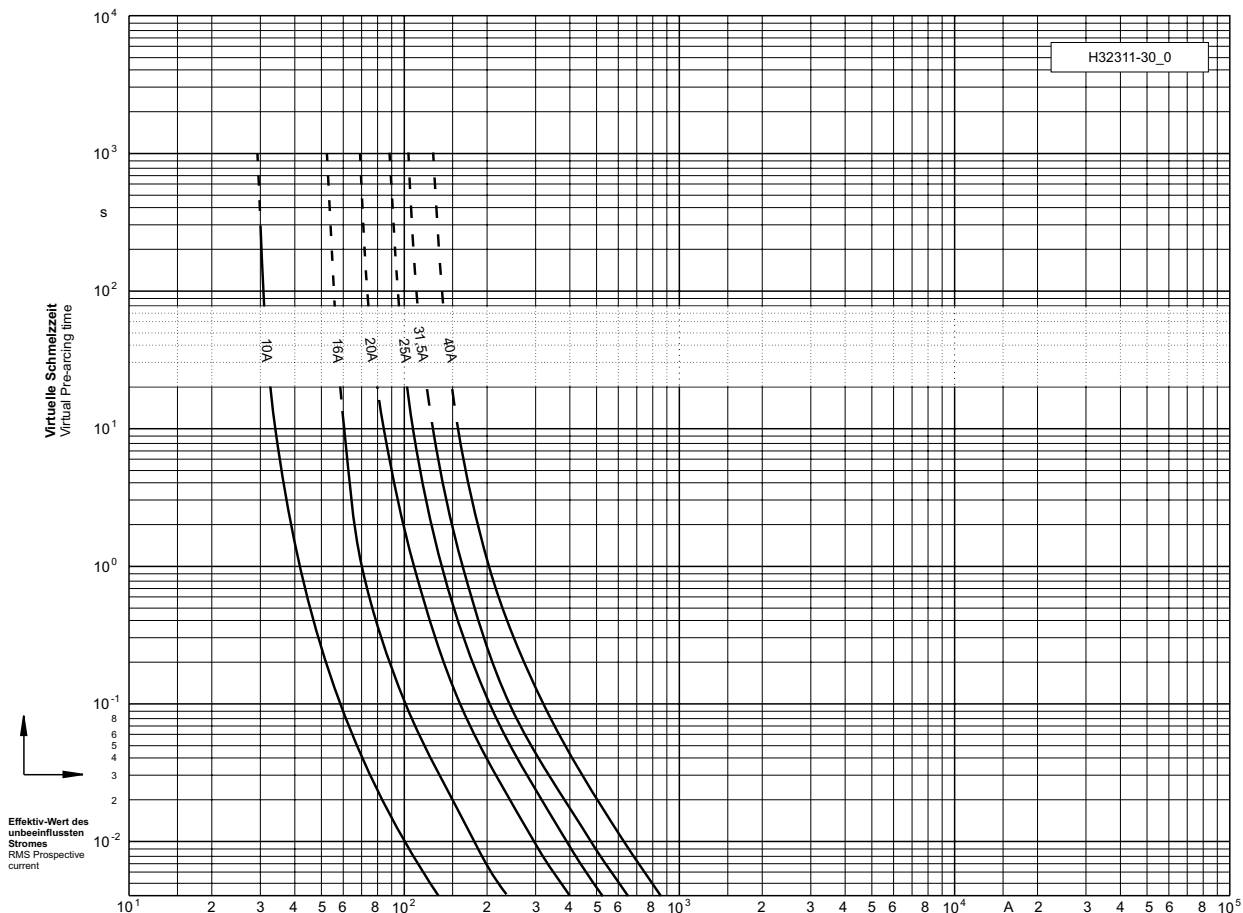

Durchlass-Strom
Cut-off current

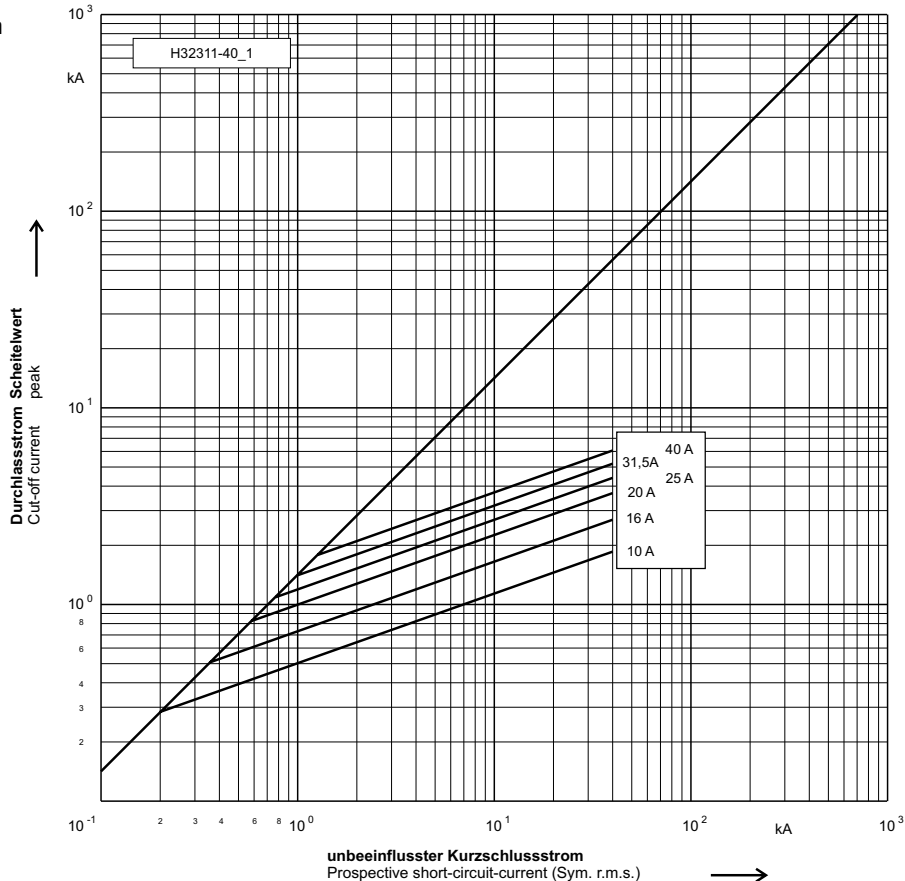

24 kV

"e" = 442 mm

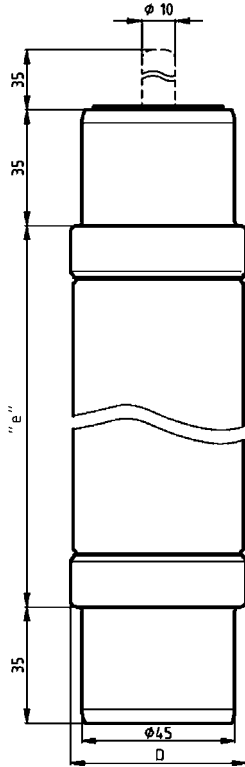

Nach DIN 43 625 / Acc. DIN 43 625
Mit und ohne Abschirmung / With and without screen

Einsatz / Application

Einbau in den Öl-Transformator / Oil-transformer application

Verpackung / Packing 1 Stück / 1 piece

Betriebsklasse / Class	IEC 60282-1	VDE 0670-4
Teilbereich / Back-up	DIN 43 625	

Bemessungs- spannung Rated Voltage	Artikel Article	Bemessungsstrom Rated Current	Länge "e" Length "e"	Durchmesser D Diameter D
kV		A	mm	mm
24	30 329 13	16	442	53
	30 330 13	16 - 31,5		53

Bemessungsstrom Rated Current	Artikel Nr. Article No.		Gewicht Weight	Bemessungs- ausschaltstrom Rated Breaking Current - I ₁	Minimaler Ausschaltstrom Min. Breaking Current - I ₃	Schmelz- integral Pre-Arcing- I ² t-Value	Ausschalt- integral Total I ² t-Value	Leistungs- abgabe Power Loss
	Abschirmung Screen	ohne Abschirmung w/o Screen						
A			kg/1	kA	A	A ² s	A ² s	W
16	30 329 13.16	30 330 13.16	2,2	63	56	250	2.000	59
20	-	30 330 13.20	2,2	63	70	640	4.800	46
25	-	30 330 13.25	2,2	63	90	1.050	7.500	56
31,5	-	30 330 13.31,5	2,2	63	110	1.700	12.000	72

24 kV

"e" = 442 mm



Zeit/Strom-Kennlinie
Time-current characteristic

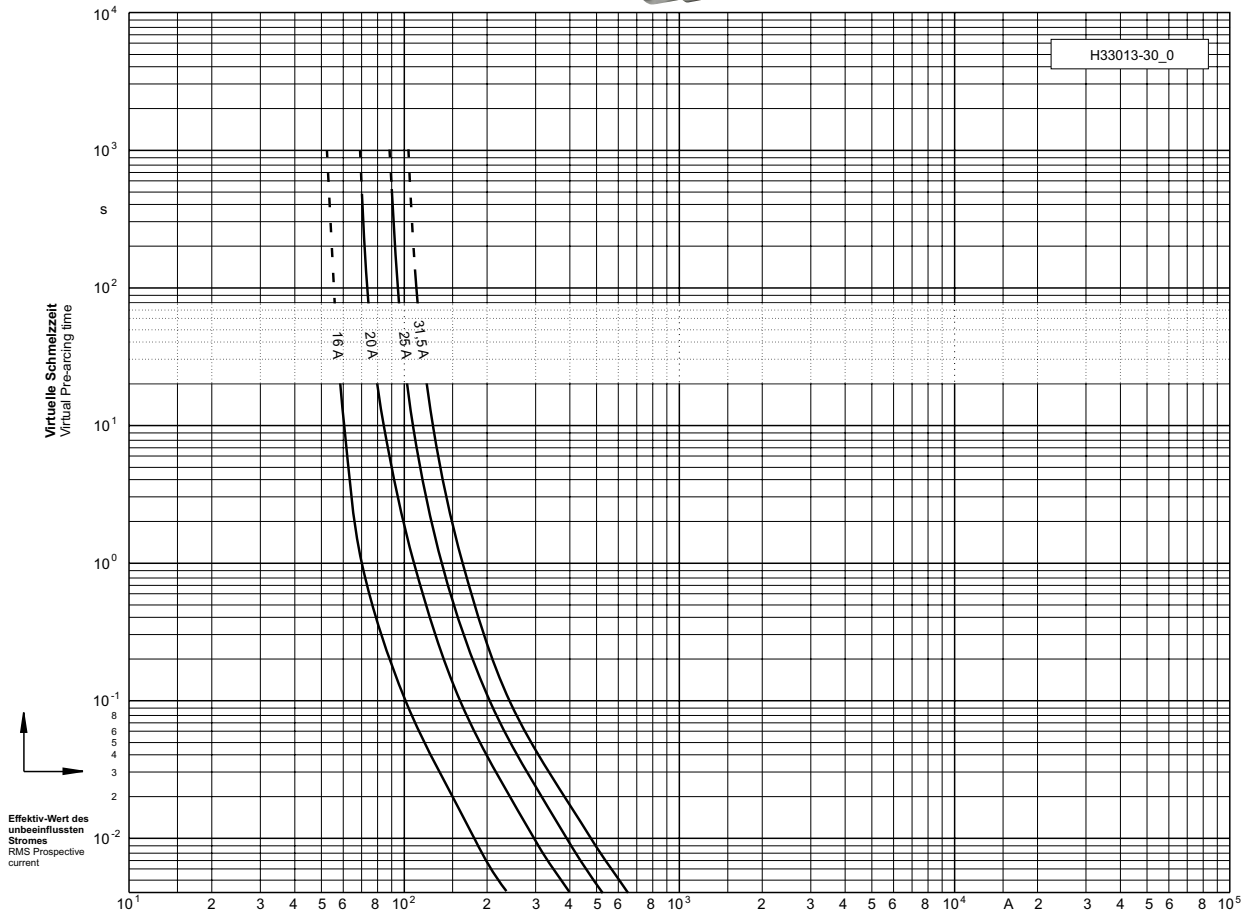

Durchlass-Strom
Cut-off current

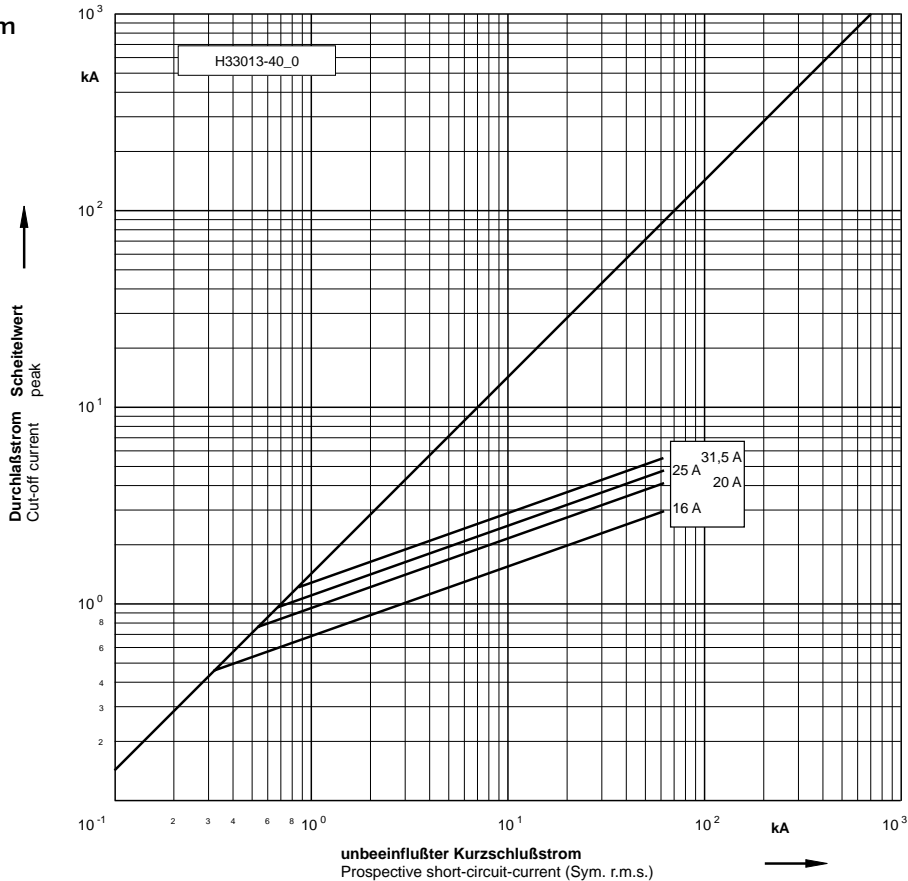

12 kV

L1 = 360 mm

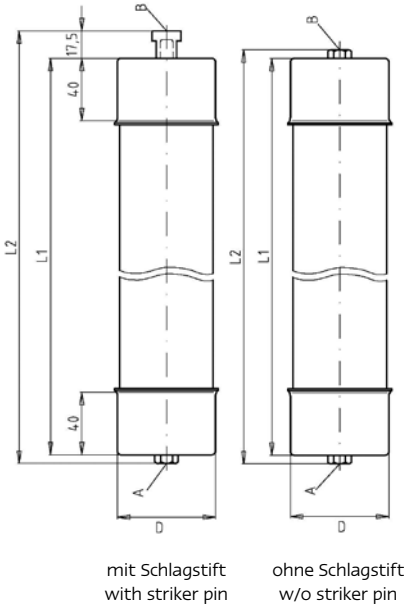

mit Schlagstift
with striker pin

ohne Schlagstift
w/o striker pin

Beidseitiges Innengewinde / Both ends female thread
Ohne Schlagstift / Without striker pin
Mit Schlagstift / With striker pin

Einsatz / Application

Einbau in den Öl-Transformator / Oil-transformer application

Verpackung / Packing 1 Stück / 1 piece

Betriebsklasse / Class **IEC 60282-1**
Vielbereich / General purpose

Bemessungs- spannung Rated Voltage	Artikel Article	Gewinde Thread		Bemessungsstrom Rated Current	Länge Length		Durchmesser D Diameter D
		A	B		L1	L2	
kV				A	mm	mm	mm
12	30 310 91	M8	M8	8 - 63	360	371	63,5
	30 310 96	M8	G1/8"		360	383	

Bemessungsstrom Rated Current	Artikel Nr. Article No.		Gewicht Weight	Bemessungs- ausschaltstrom Rated Breaking Current - I ₁	Minimaler Ausschaltstrom Min. Breaking Current - I ₃	Schmelzintegral Pre-Arcing-I ² t- Value	Ausschalt- integral Total I ² t- Value	Leistungs- abgabe Power Loss
	o. Schlagstift w/o striker pin	m. Schlagstift striker pin						
A			kg/1	kA	A	A ² s	A ² s	W
8	30 310 91.8	30 310 96.8	2,6	63	25	172	1.800	8
10	30 310 91.10	30 310 96.10	2,6	63	29	250	2.800	11
12	30 310 91.12	30 310 96.12	2,6	63	37	340	3.800	13
16	30 310 91.16	30 310 96.16	2,6	63	42	830	9.200	17
20	30 310 91.20	30 310 96.20	2,6	63	60	1.730	17.300	20
22	30 310 91.22	30 310 96.22	2,6	63	67	2.260	22.600	12
40	30 310 91.40	30 310 96.40	2,6	63	80	3.530	35.500	35
50	30 310 91.50	30 310 96.50	2,6	63	96	5.490	55.000	46
63	30 310 91.63	30 310 96.63	2,6	63	123	9.030	90.000	62

12 kV

L1 = 360 mm



Zeit/Strom-Kennlinie
Time-current characteristic

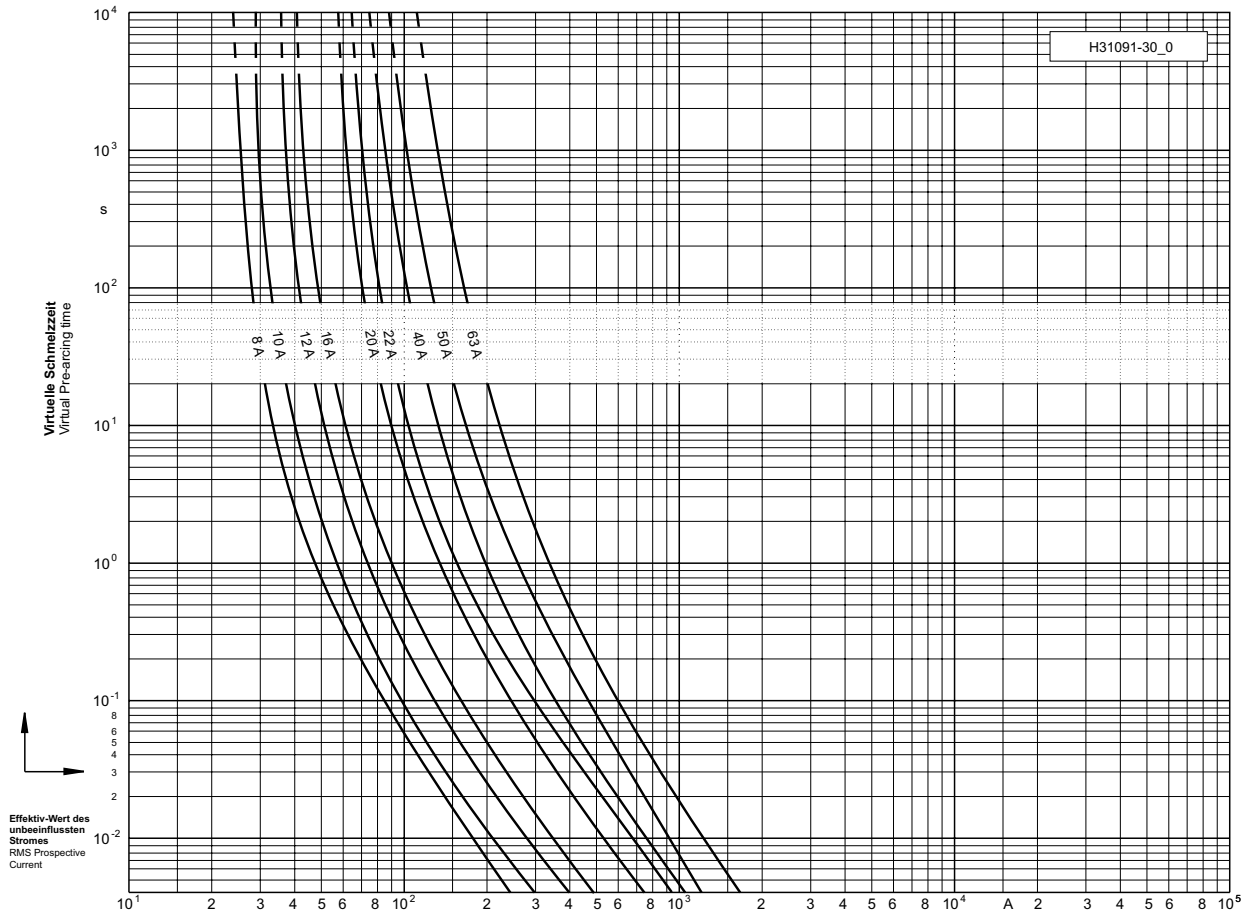

Durchlass-Strom
Cut-off current

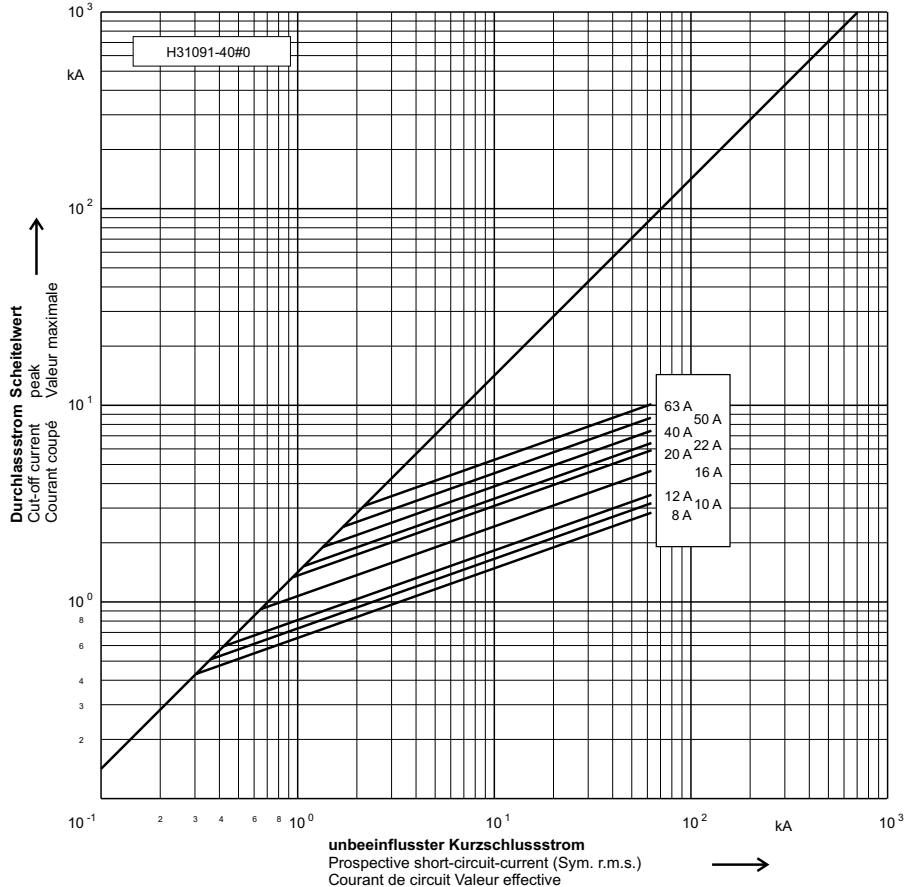

17,5 kV

L1 = 360 mm

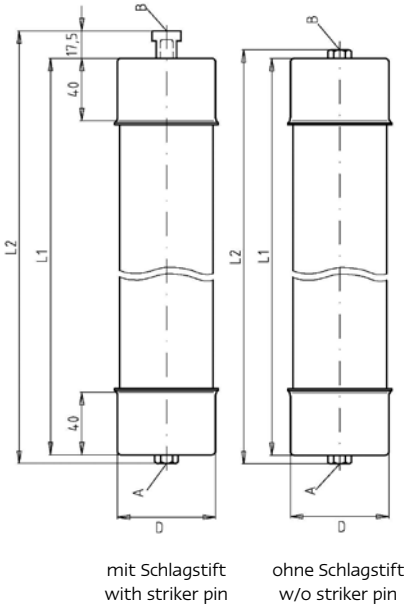

mit Schlagstift
with striker pin

ohne Schlagstift
w/o striker pin

Beidseitiges Innengewinde / Both ends female thread
Ohne Schlagstift / Without striker pin
Mit Schlagstift / With striker pin

Einsatz / Application

Einbau in den Öl-Transformator / Oil-transformer application

Verpackung / Packing 1 Stück / 1 piece

Betriebsklasse / Class Vielbereich / General purpose	IEC 60282-1
--	--------------------

Bemessungs- spannung Rated Voltage	Artikel Article	Gewinde Thread		Bemessungsstrom Rated Current	Länge Length		Durchmesser D Diameter D
		A	B		L1	L2	
kV				A	mm	mm	mm
17,5	30 311 91	M8	M8	10 - 20	360	371	63,5
	30 311 96	M8	G1/8"		360	383	

Bemessungsstrom Rated Current	Artikel Nr. Article No.		Gewicht Weight	Bemessungs- ausschaltstrom Rated Breaking Current - I ₁	Minimaler Ausschaltstrom Min. Breaking Current - I ₃	Schmelzintegral Pre-Arcing-I ² t- Value	Ausschalt- integral Total I ² t- Value	Leistungs- abgabe Power Loss
	o. Schlagstift w/o striker pin	m. Schlagstift striker pin						
A			kg/1	kA	A	A ² s	A ² s	W
10	30 311 91.10	30 311 96.10	2,6	63	33	250	2.400	16
16	30 311 91.16	30 311 96.16	2,6	63	41	1.100	12.000	18
20	30 311 91.20	30 311 96.20	2,6	63	57	1.700	13.500	18

17,5 kV

L1 = 360 mm



Zeit/Strom-Kennlinie
Time-current characteristic

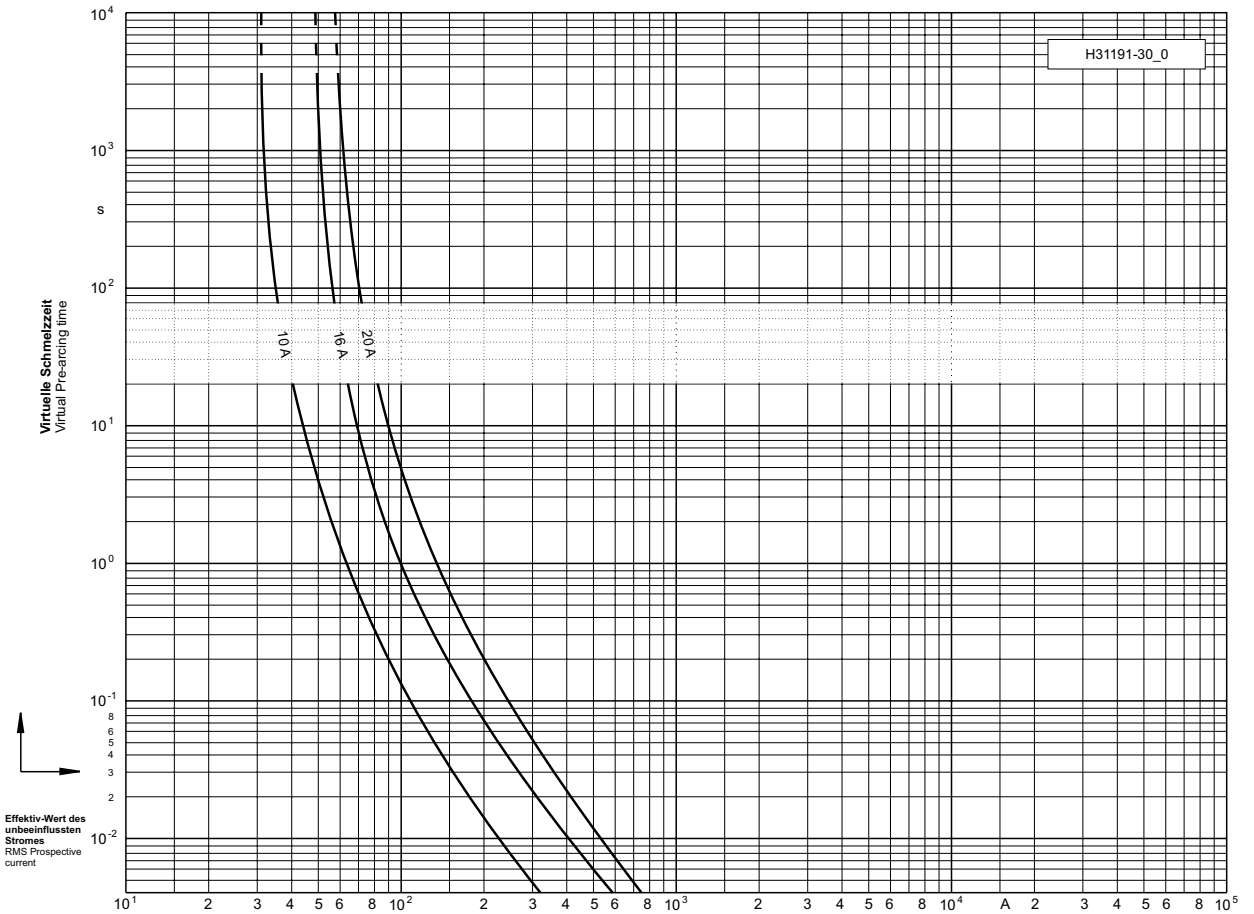

Durchlass-Strom
Cut-off current

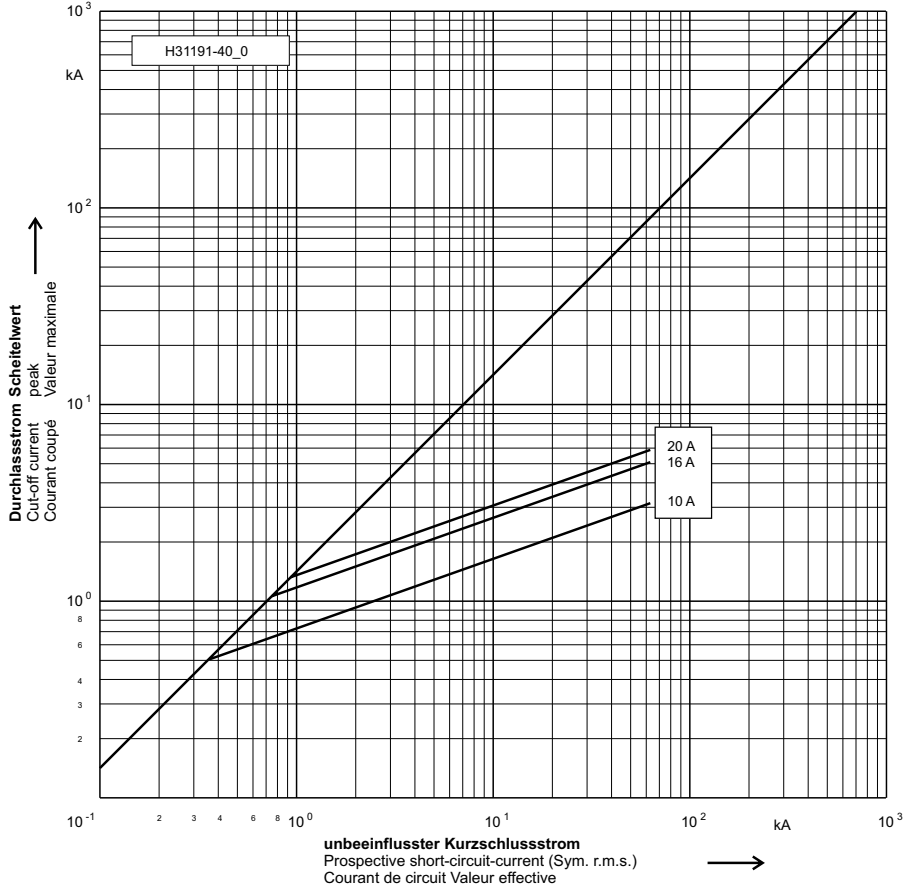

24 kV

L1 = 360 mm

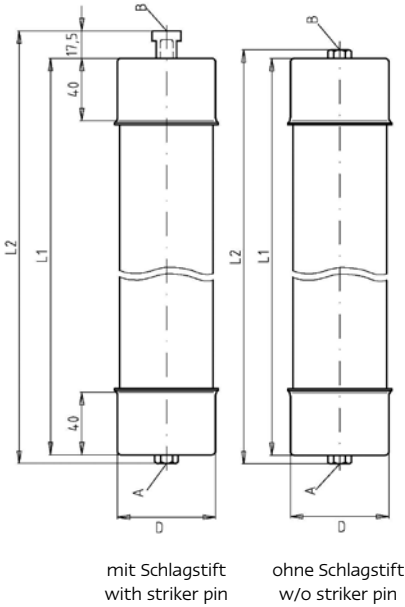

mit Schlagstift
with striker pin

ohne Schlagstift
w/o striker pin

Beidseitiges Innengewinde / Both ends female thread
Ohne Schlagstift / Without striker pin
Mit Schlagstift / With striker pin

Einsatz / Application

Einbau in den Öl-Transformator / Oil-transformer application

Verpackung / Packing 1 Stück / 1 piece

Betriebsklasse / Class **IEC 60282-1**
Vielbereich / General purpose

Bemessungs- spannung Rated Voltage	Artikel Article	Gewinde Thread		Bemessungsstrom Rated Current	Länge Length		Durchmesser D Diameter D
		A	B		L1	L2	
kV				A	mm	mm	mm
24	30 312 91	M8	M8	8 - 20	360	371	63,5
	30 312 96	M8	M1/8"		360	383	

Bemessungs- strom Rated Current	Artikel Nr. Article No.		Gewicht Weight	Bemessungs- ausschaltstrom Rated Breaking Current - I ₁	Minimaler Ausschaltstrom Min. Breaking Current - I ₃	Schmelzintegral Pre-Arcing-I ² t- Value	Ausschalt- integral Total I ² t-Value	Leistungs- abgabe Power Loss
	o. Schlagstift w/o striker pin	m. Schlagstift striker pin						
A			kg/1	kA	A	A ² s	A ² s	W
8	30 312 91.8	30 312 96.8	2,6	63	25	172	1.900	17
10	30 312 91.10	30 312 96.10	2,6	63	29	250	2.800	21
12	30 312 91.12	30 312 96.12	2,6	63	37	460	5.100	24
16	30 312 91.16	30 312 96.16	2,6	63	42	830	8.300	31
20	30 312 91.20	30 312 96.20	2,6	63	60	1.730	17.300	21

24 kV

L1 = 360 mm



Zeit/Strom-Kennlinie
Time-current characteristic

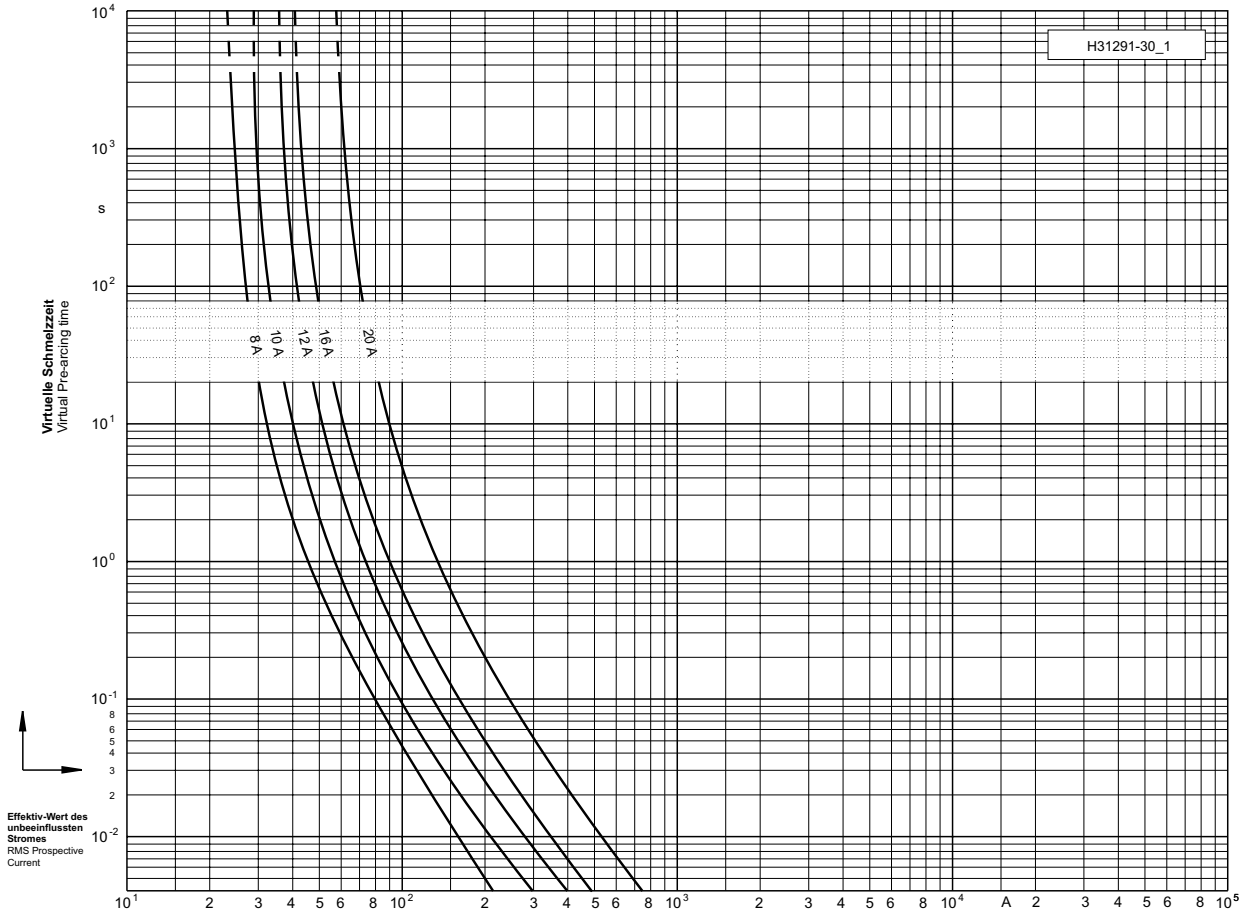

Durchlass-Strom
Cut-off current

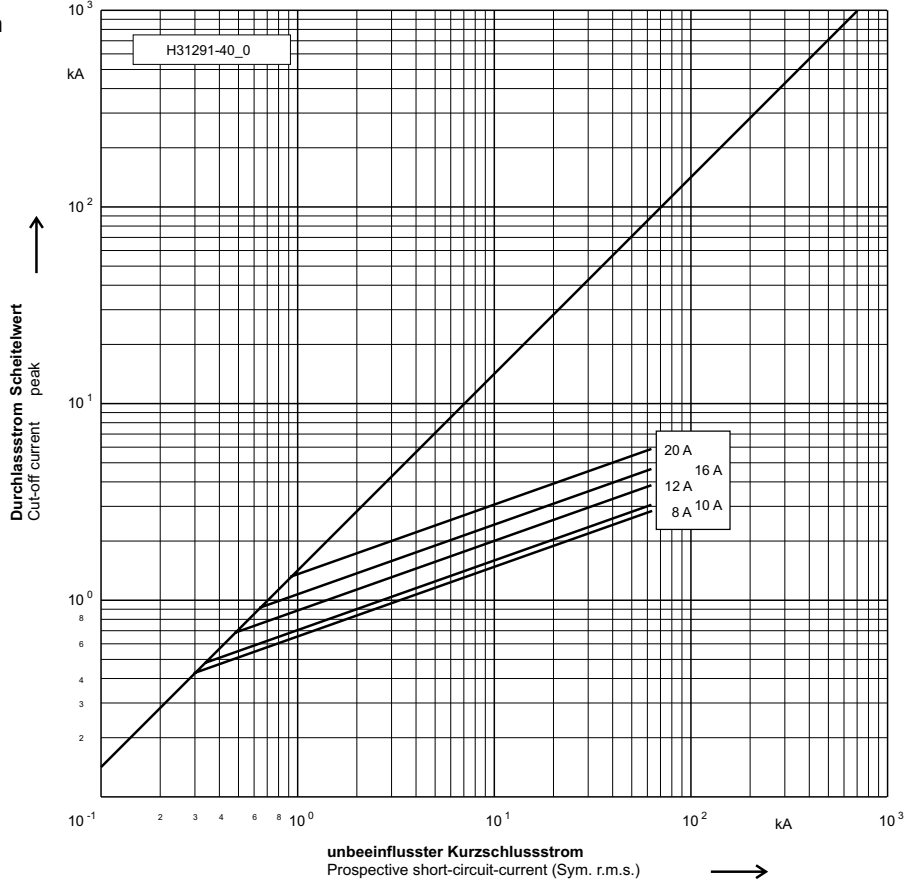

24 kV

L1 = 440 mm

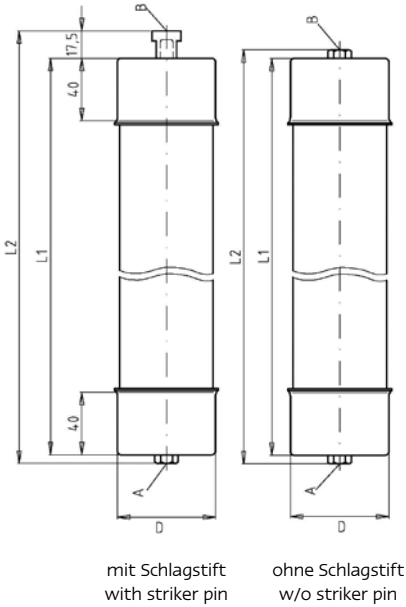
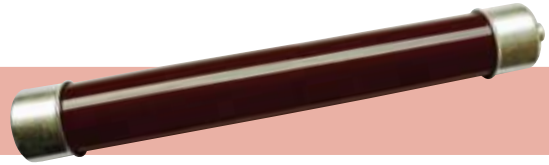

mit Schlagstift
with striker pin

ohne Schlagstift
w/o striker pin

Beidseitiges Innengewinde / Both ends female thread
Ohne Schlagstift / Without striker pin
Mit Schlagstift / With striker pin

Einsatz / Application

Einbau in den Öl-Transformator / Oil-transformer application

Verpackung / Packing 1 Stück / 1 piece

Betriebsklasse / Class Vielbereich / General purpose	IEC 60282-1
--	--------------------

Bemes- sungs- span- nung Rated Vol- tage	Artikel Article	Gewinde Thread		Bemessungsstrom Rated Current	Länge Length		Durchmesser D Diameter D
		A	B		L1	L2	
kV				A	mm	mm	mm
24	30 313 91	M8	M8	25 - 40	440	451	63,5
	30 313 96	M8	M1/8"		440	463	

Bemessungsstrom Rated Current	Artikel Nr. Article No.		Gewicht Weight	Bemessungs- ausschaltstrom Rated Breaking Current - I ₁	Minimaler Ausschaltstrom Min. Breaking Current - I ₃	Schmelzintegral Pre-Arcing-I ² t- Value	Ausschalt- integral Total I ² t-Value	Leistungs- abgabe Power Loss
	o. Schlagstift w/o striker pin	m. Schlagstift striker pin						
A			kg/1	kA	A	A ² s	A ² s	W
25	30 313 91.25	30 313 96.25	3,6	63	57	1.150	10.500	40
31,5	30 313 91.31,5	30 313 96.31,5	3,6	63	72	2.100	16.500	55
40	30 313 91.40	30 313 96.40	3,6	63	84	2.850	19.500	71

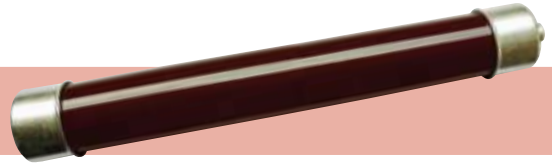

24 kV

L1 = 440 mm

Zeit/Strom-Kennlinie
Time-current characteristic

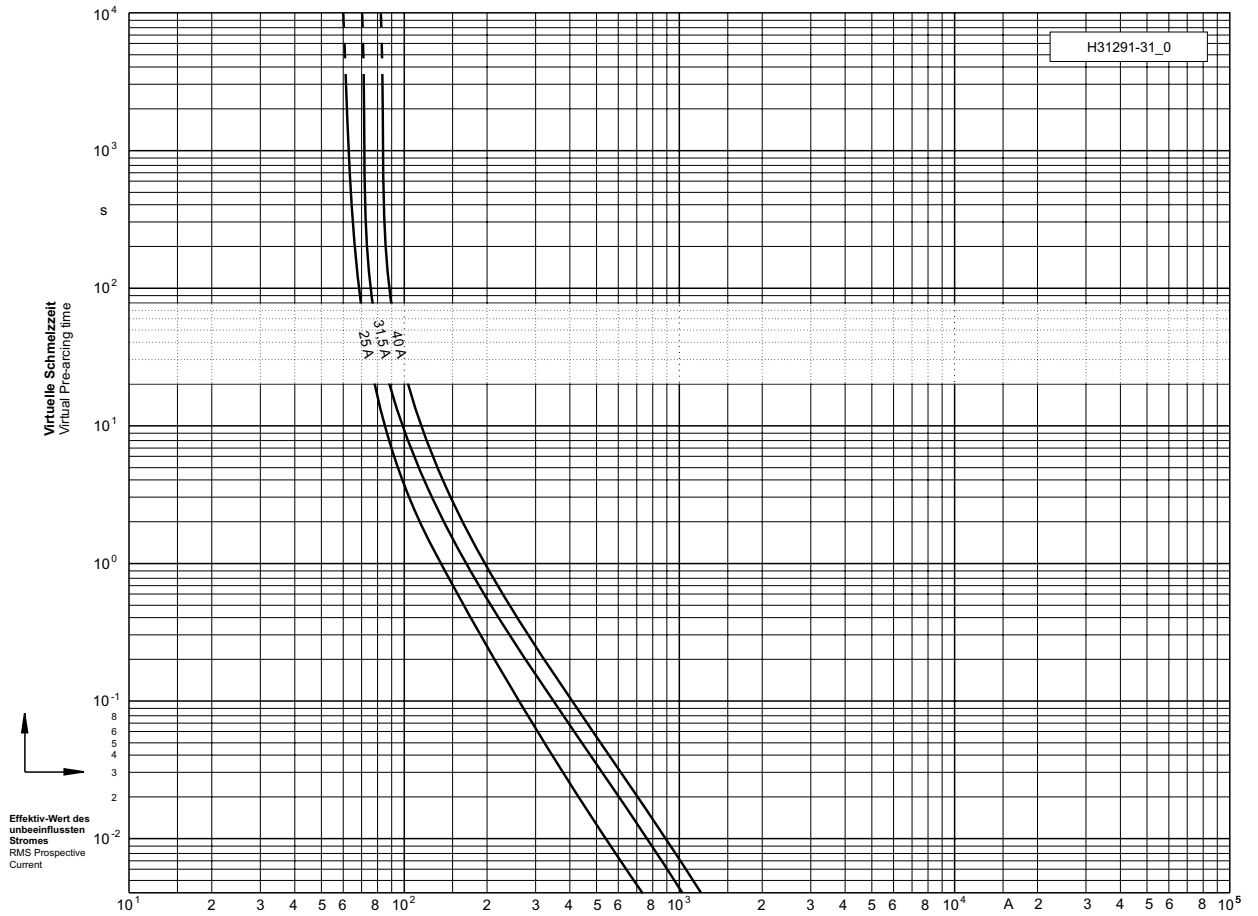

Durchlass-Strom
Cut-off current

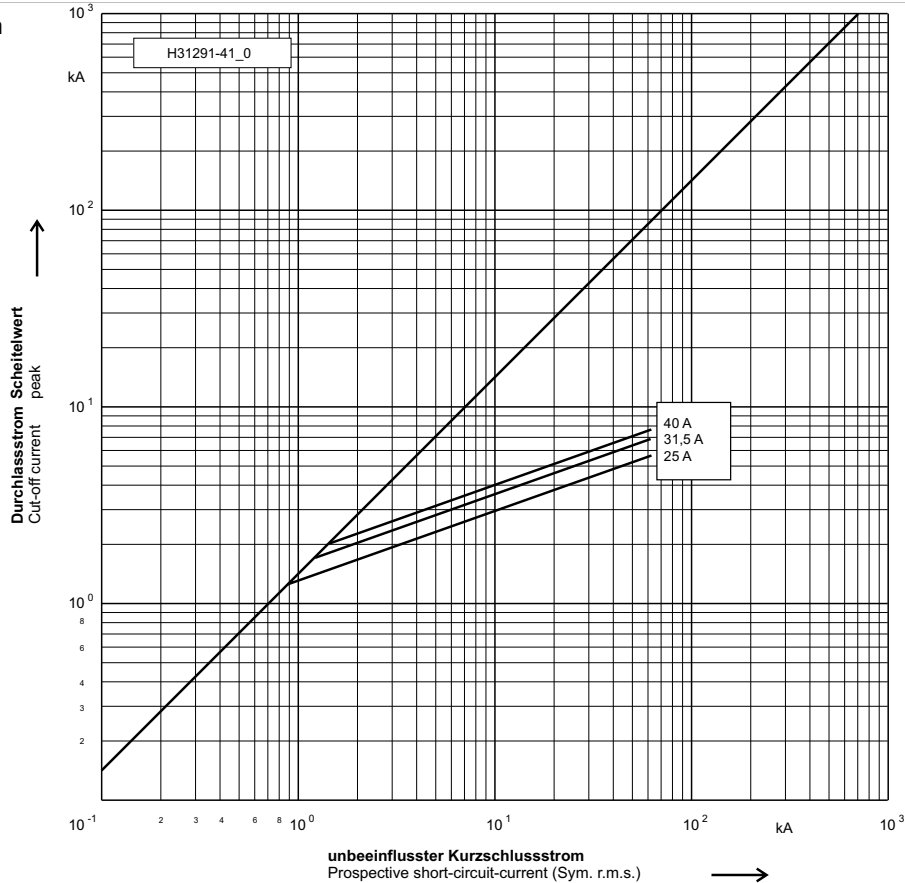

24 kV

L = 461 mm

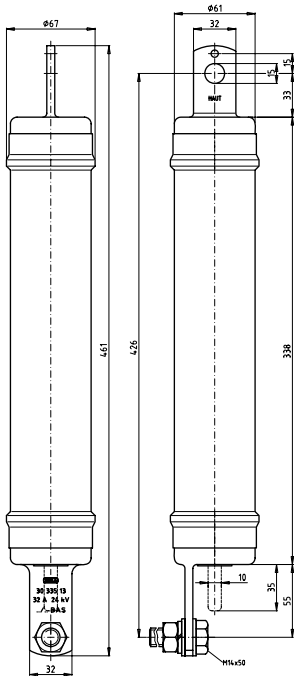
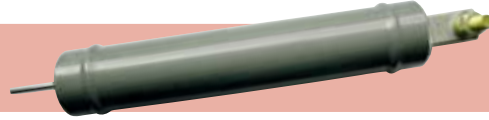

**Transformatorschutz in Freileitungsnetzen/
Transformer protection in overhead networks
Mit Schlagstift / With striker pin**

Einsatz / Application

Mit Steckverbindern / With plug-connectors

Verpackung / Packing 1 Stück / 1 piece

Betriebsklasse / Class
Teilbereich / Back-up

**IEC 60282-1
VDE 0670**

Bemessungs- spannung Rated Voltage	Artikel Article	Bemessungsstrom Rated Current	Länge L Length L	Durchmesser D Diameter D
kV		A	mm	mm
24	30 335 13	32	461	67

Bemessungsstrom Rated Current	Artikel Nr. Article No.	Gewicht Weight	Bemessungs- ausschaltstrom Rated Breaking Current - I ₁	Minimaler Ausschaltstrom Min. Breaking Current - I ₃	Schmelzintegral Pre-Arcing-I ² t- Value	Ausschalt- integral Total I ² t-Value	Leistungs- abgabe Power Loss	Kaltwider- stand Cold Resistance
A		kg/1	kA	A	A ² s	A ² s	W	mΩ
32	30 335 13.32	2,2	20	200	3.680	20.500	43	35

24 kV

L = 461 mm



Zeit/Strom-Kennlinie
Time-current characteristic

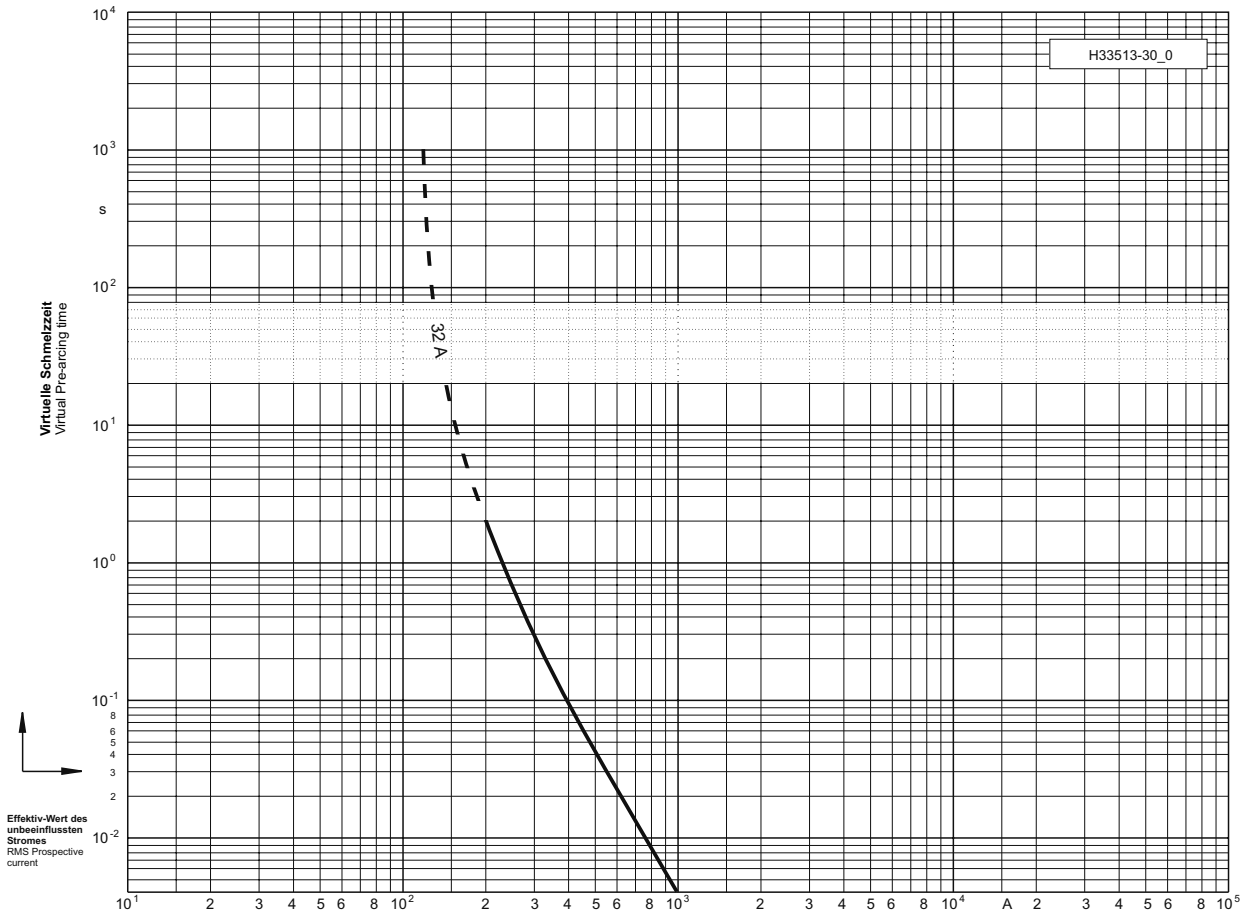

Durchlass-Strom
Cut-off current

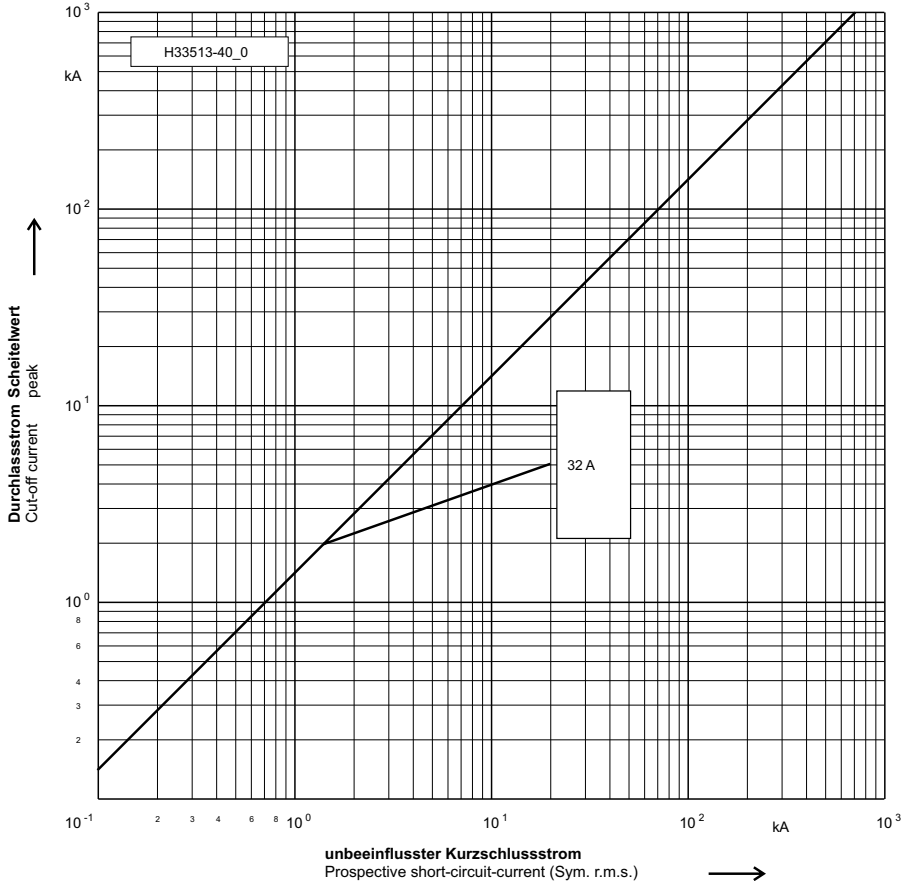

3/7,2 kV L = 220 mm

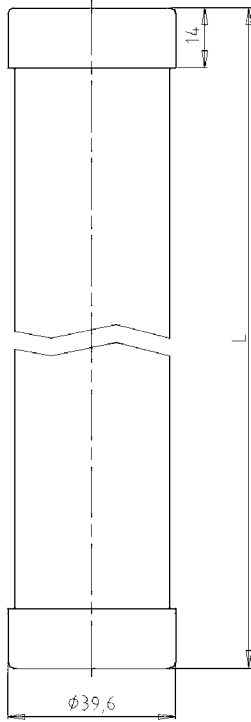

Einsatz / Application

Für den Schutz von Spannungswandlern / For voltage transformer protection

Verpackung / Packing 1 Stück / 1 piece

Betriebsklasse / Class Teilbereich / Back-up	Werksnorm	Company Standard
--	------------------	-------------------------

Bemessungs- spannung Rated Voltage	Artikel Article	Bemessungsstrom Rated Current	Länge L Length L	Durchmesser D Diameter D
kV		A	mm	mm
3/7,2	30 371 11	1 - 5	220	39,6

Bemessungs- strom Rated Current	Artikel Nr. Article No.	Gewicht Weight	Bemessungs- ausschaltstrom Rated Breaking Current - I ₁	Minimaler Ausschaltstrom Min. Breaking Current - I ₃	Schmelzintegral Pre-Arcing- I ² t-Value	Ausschaltintegral Total I ² t-Value	Leistungsabgabe Power Loss
A		kg/1	kA	A	A ² s	A ² s	W
1	30 371 11.1	0,7	63	8	0,6	1,9	3,1
2	30 371 11.2	0,7	63	16	3,2	9,9	5,5
3	30 371 11.3	0,7	63	24	16,1	47,8	6,1
4	30 371 11.4	0,7	63	32	28,9	85,3	7,4
5	30 371 11.5	0,7	63	40	40,9	120,7	9,0

3/7,2 kV L = 220 mm



Zeit/Strom-Kennlinie
Time-current characteristic

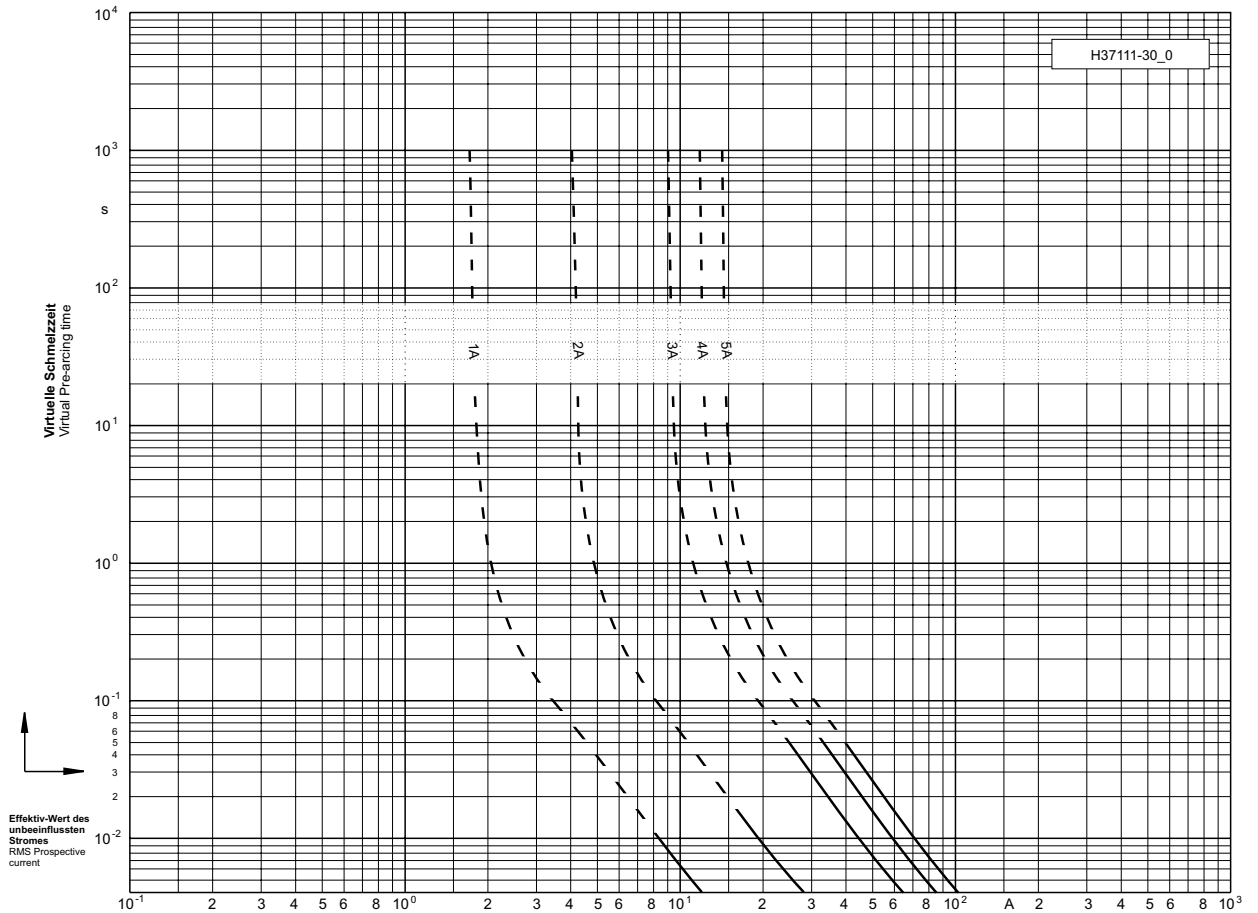

Durchlass-Strom
Cut-off current

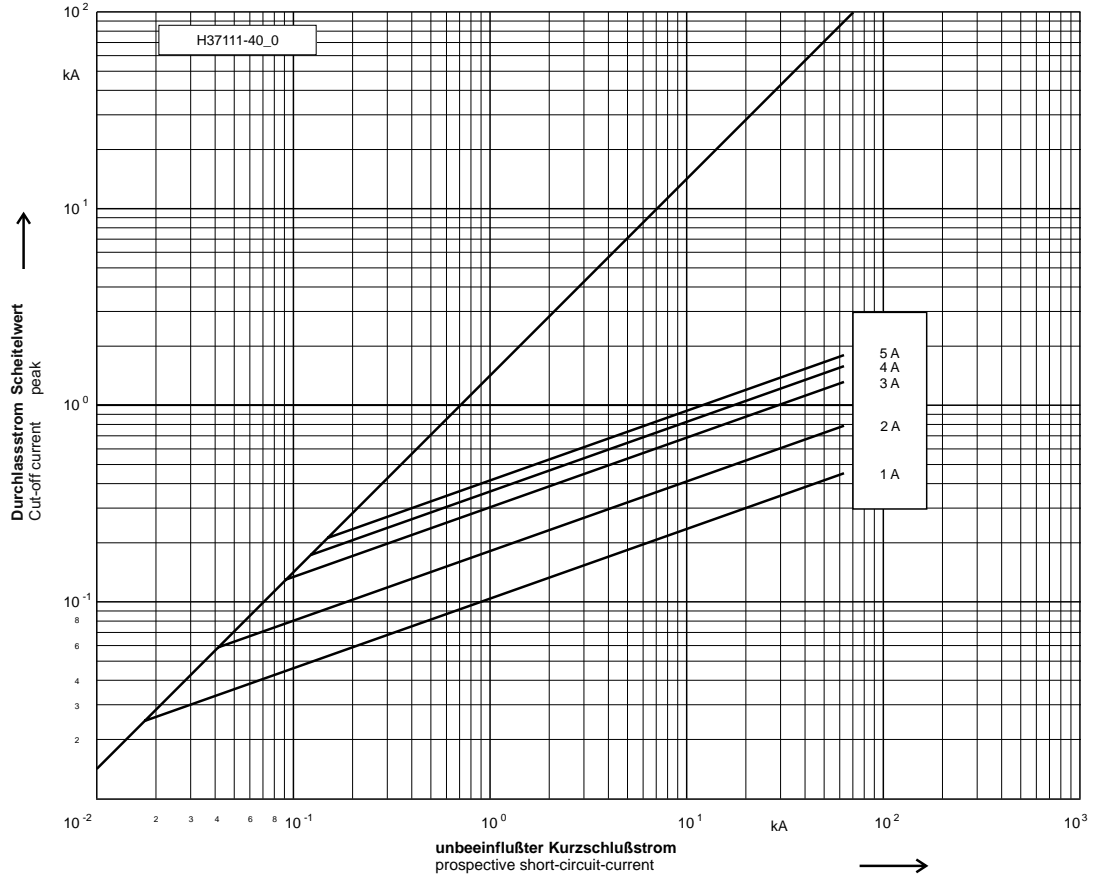

3/7,2 kV L = 142 mm / 195 mm

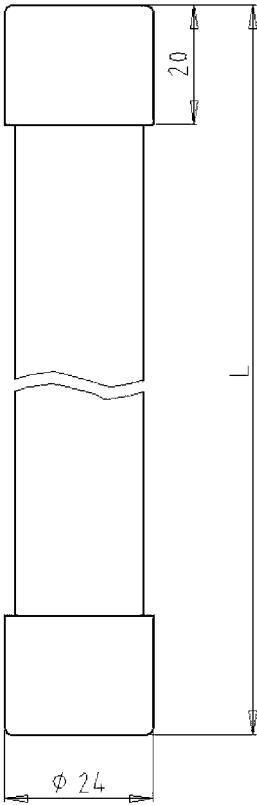

Einsatz / Application

Für den Schutz von Spannungswandlern / For voltage transformer protection

Verpackung / Packing 1 Stück / 1 piece

Betriebsklasse / Class Teilbereich / Back-up	Werksnorm	Company Standard
---	-----------	------------------

Bemessungs- spannung Rated Voltage	Artikel Article	Bemessungsstrom Rated Current	Länge L Length L	Durchmesser D Diameter D
kV		A	mm	mm
3/7,2	30 383 11	1 - 3	142	24
	30 377 11	1 - 3	195	24

Bemessungs- strom Rated Current	Artikel Nr. Article No.		Gewicht Weight	Bemessungs- ausschaltstrom Rated Breaking Current - I ₁	Minimaler Ausschaltstrom Min. Breaking Current - I ₃	Schmelzintegral Pre-Arcing- I ² t-Value	Ausschaltinte- gral Total I ² t-Value	Leistungsabgabe Power Loss
A			kg/1	kA	A	A ² s	A ² s	W
1	30 383 11.1	30 377 11.1	0,2	63	8	0,6	1,9	3,2
2	30 383 11.2	30 377 11.2	0,2	63	16	3,2	9,9	5,8
3	30 383 11.3	30 377 11.3	0,2	63	24	16,1	47,8	6,3

3/7,2 kV L = 142 mm / 195 mm



Zeit/Strom-Kennlinie
Time-current characteristic

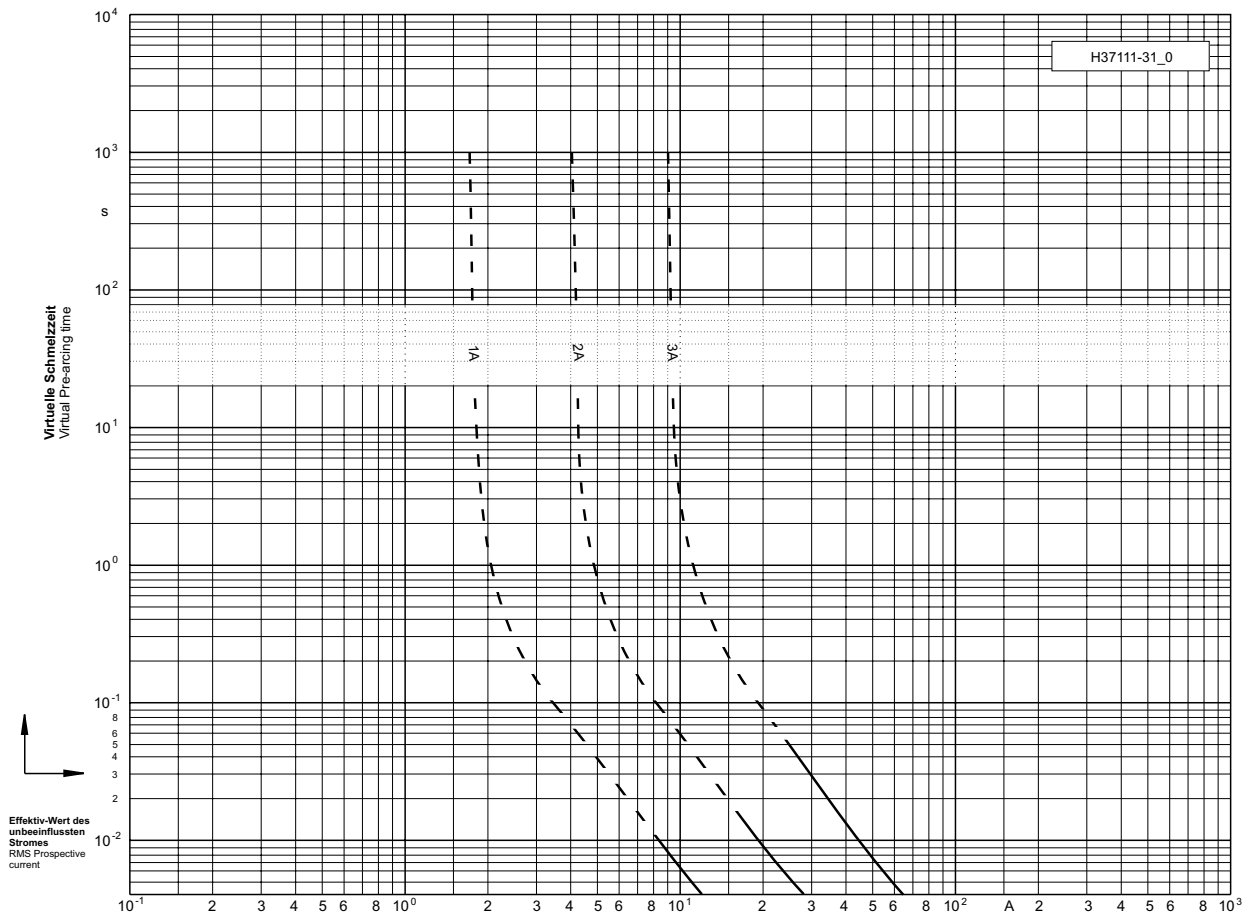

Durchlass-Strom
Cut-off current

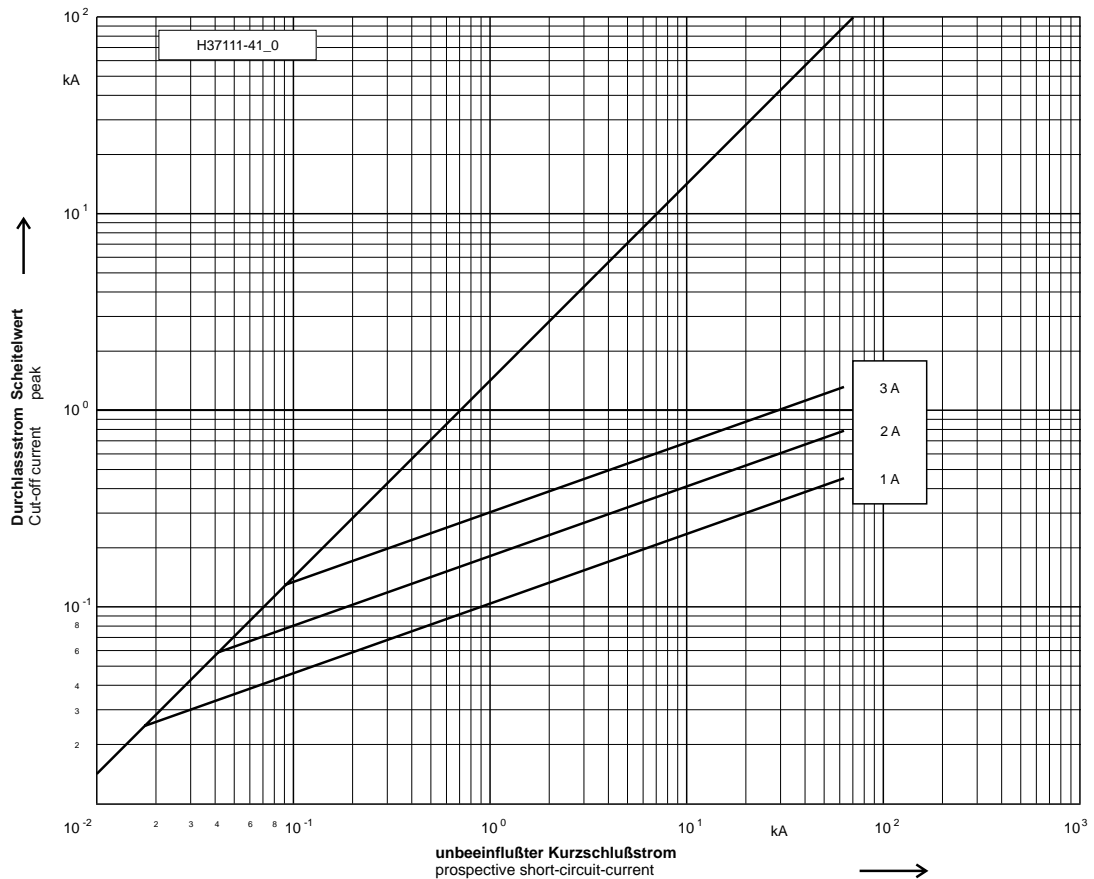

6/12 kV

L = 220 mm

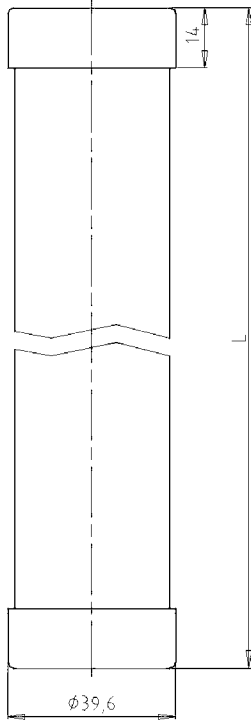

Einsatz / Application

Für den Schutz von Spannungswandlern / For voltage transformer protection

Verpackung / Packing 1 Stück / 1 piece

Betriebsklasse / Class Teilbereich / Back-up	Werksnorm	Company Standard
---	-----------	------------------

Bemessungs- spannung Rated Voltage	Artikel Article	Bemessungsstrom Rated Current	Länge L Length L	Durchmesser D Diameter D
kV		A	mm	mm
6/12	30 372 11	1 - 5	220	39,6

Bemessungs- strom Rated Current	Artikel Nr. Article No.	Gewicht Weight	Bemessungs- ausschaltstrom Rated Breaking Current - I ₁	Minimaler Ausschaltstrom Min. Breaking Current - I ₃	Schmelzintegral Pre-Arcing- I ² t-Value	Ausschaltintegral Total I ² t-Value	Leistungsabgabe Power Loss
A		kg/1	kA	A	A ² s	A ² s	W
1	30 372 11.1	0,7	63	8	0,6	1,9	5,3
2	30 372 11.2	0,7	63	16	3,2	9,9	9,4
3	30 372 11.3	0,7	63	24	16,1	47,8	11
4	30 372 11.4	0,7	63	32	28,9	85,3	12
5	30 372 11.5	0,7	63	40	40,9	120,7	16

6/12 kV

L = 220 mm



Zeit/Strom-Kennlinie
Time-current characteristic

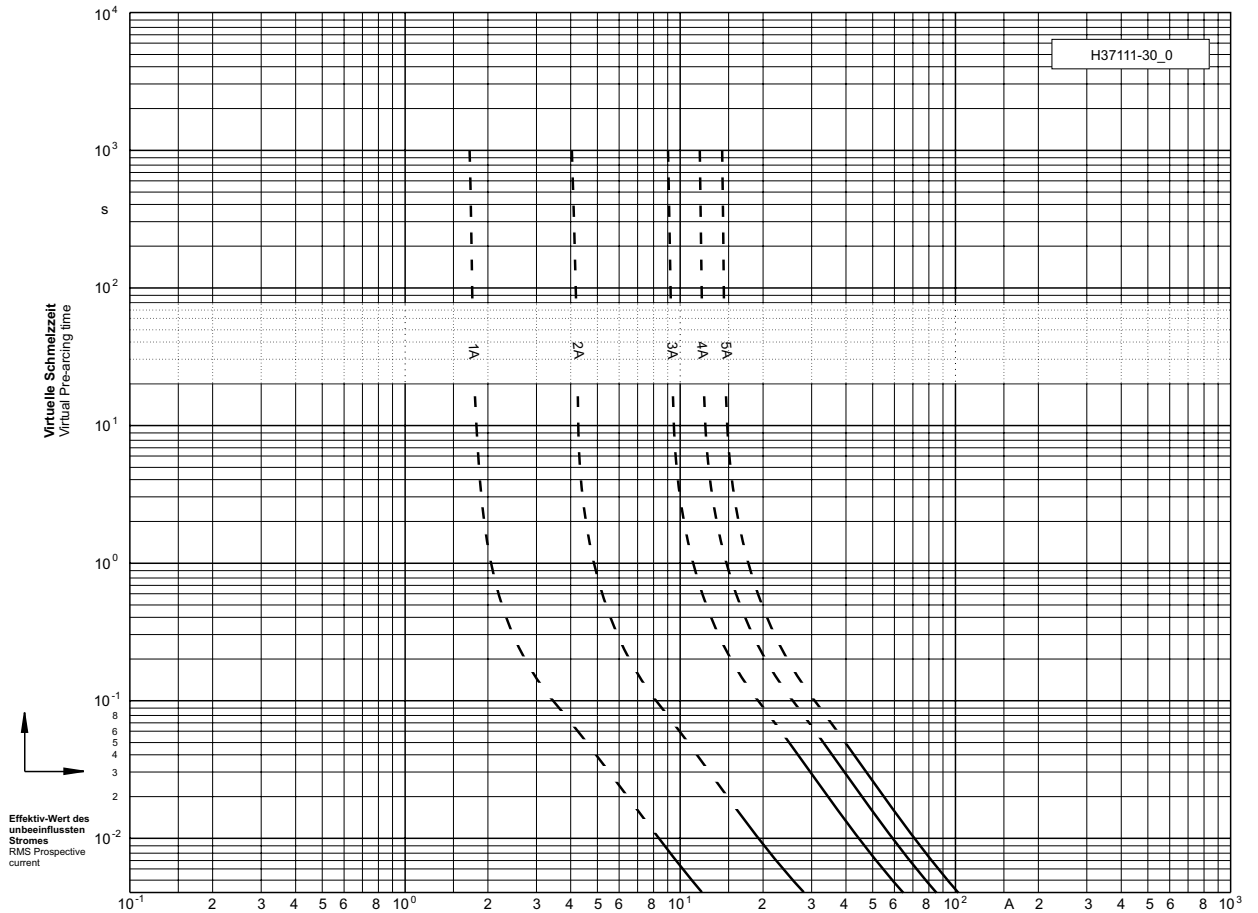

Durchlass-Strom
Cut-off current

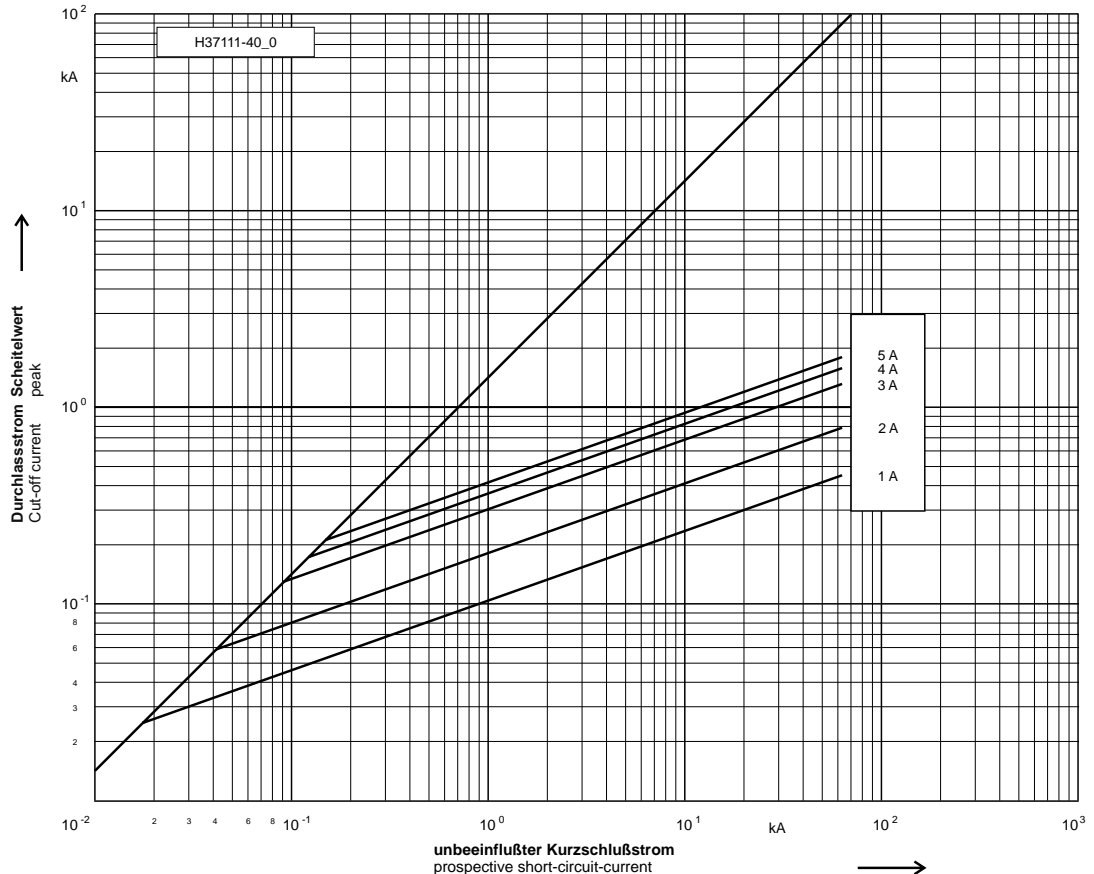

6/12 kV

L = 195 mm

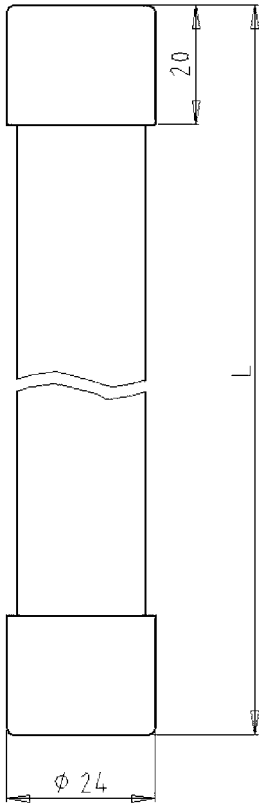
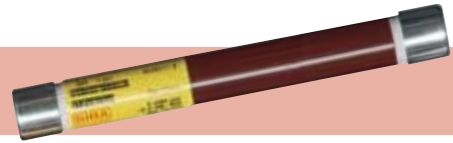

Einsatz / Application

Für den Schutz von Spannungswandlern / For voltage transformer protection

Verpackung / Packing 1 Stück / 1 piece

Betriebsklasse / Class Teilbereich / Back-up	Werksnorm	Company Standard
---	-----------	------------------

Bemessungs- spannung Rated Voltage	Artikel Article	Bemessungsstrom Rated Current	Länge L Length L	Durchmesser D Diameter D
kV		A	mm	mm
6/12	30 378 11	1 - 3	195	24

Bemessungs- strom Rated Current	Artikel Nr. Article No.	Gewicht Weight	Bemessungs- ausschaltstrom Rated Breaking Current - I ₁	Minimaler Ausschaltstrom Min. Breaking Current - I ₃	Schmelzintegral Pre-Arcing- I ² t-Value	Ausschaltintegral Total I ² t-Value	Leistungsabgabe Power Loss
A		kg/1	kA	A	A ² s	A ² s	W
1	30 378 11.1	0,2	63	8	0,6	1,9	5,5
2	30 378 11.2	0,2	63	16	3,2	9,9	10
3	30 378 11.3	0,2	63	24	16,1	47,8	11

6/12 kV

L = 195 mm

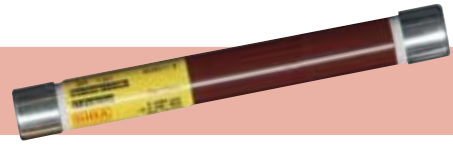

Zeit/Strom-Kennlinie
Time-current characteristic

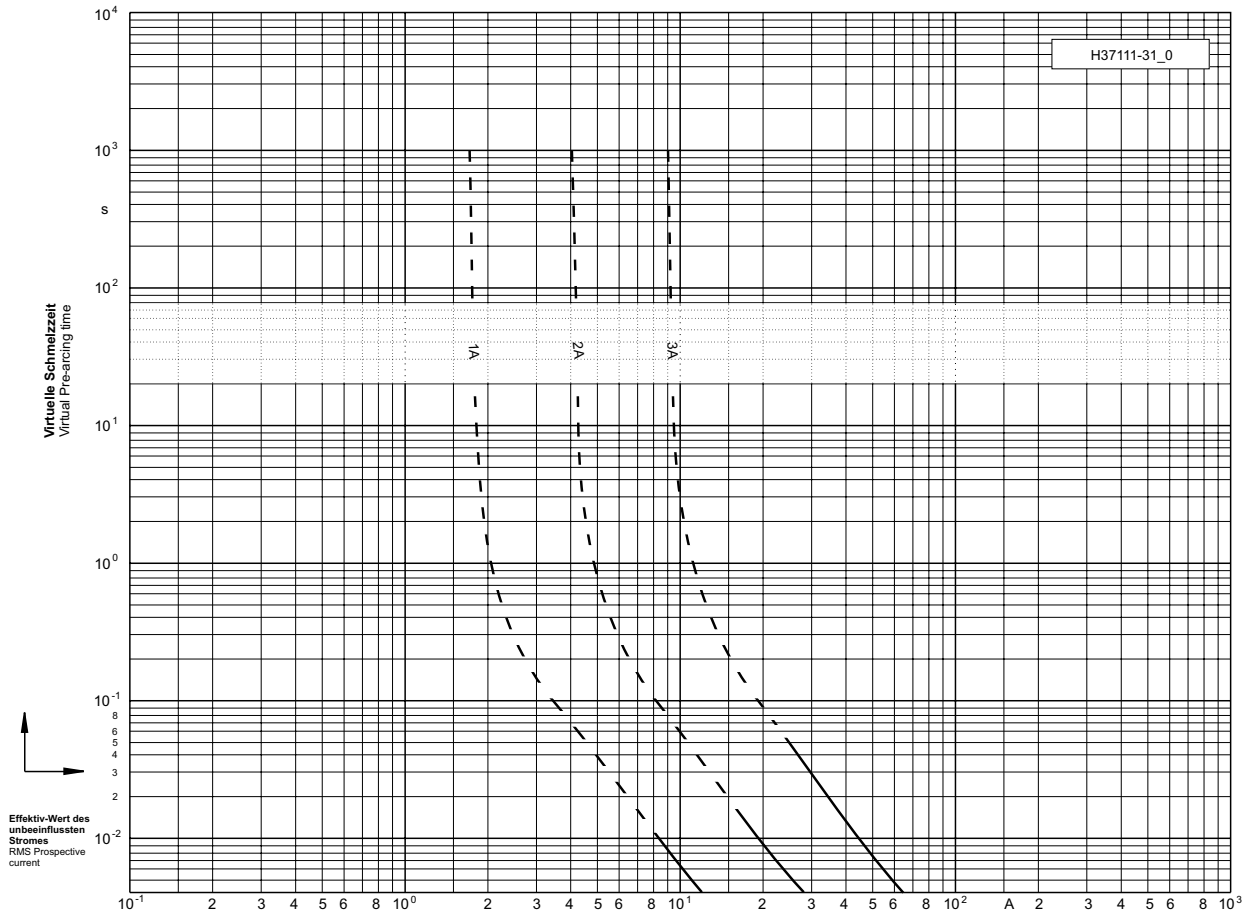

Durchlass-Strom
Cut-off current

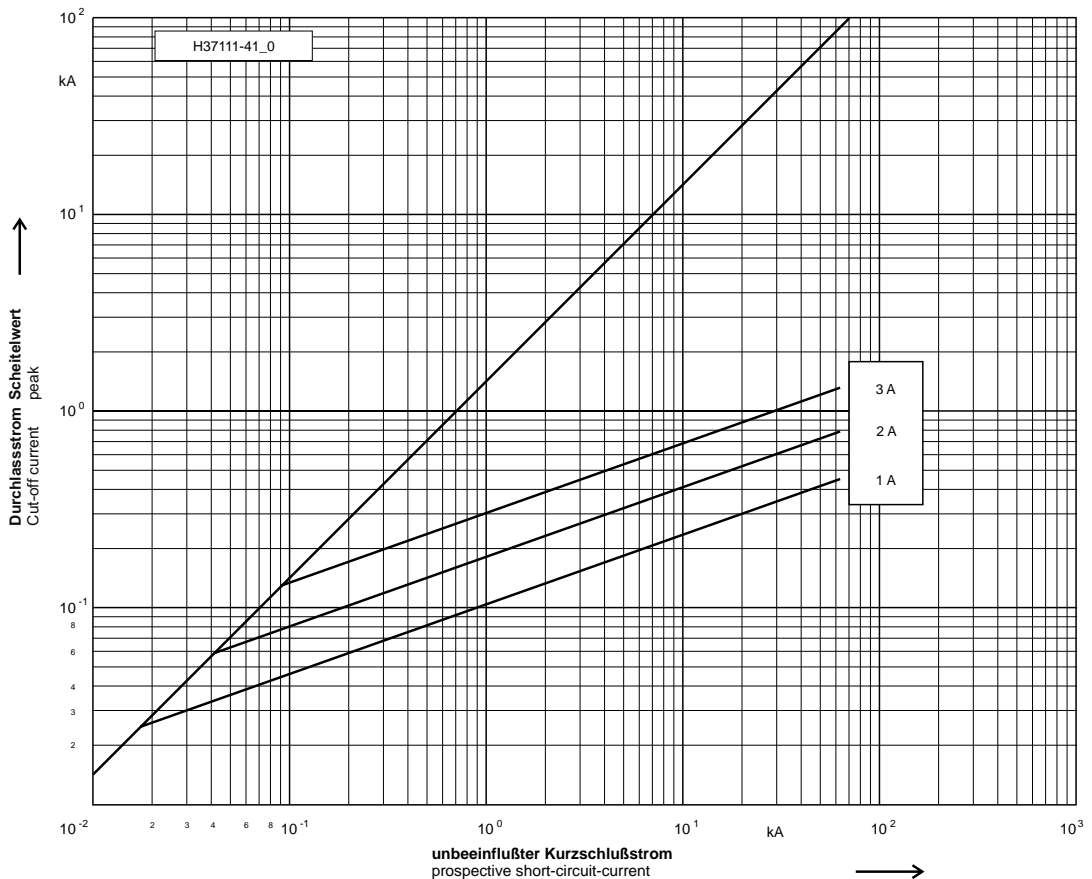

10/17,5 kV L = 340 mm

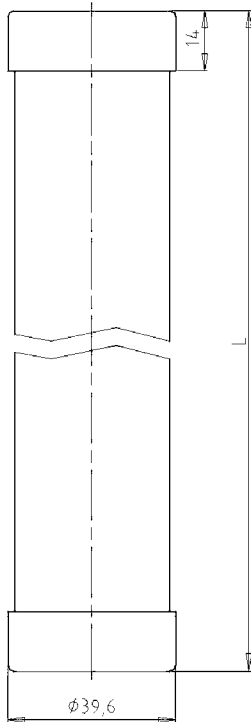
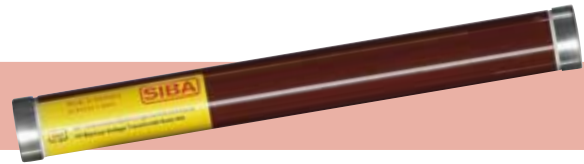

Einsatz / Application

Für den Schutz von Spannungswandlern / For voltage transformer protection

Verpackung / Packing 1 Stück / 1 piece

Betriebsklasse / Class Teilbereich / Back-up	Werksnorm	Company Standard
--	------------------	-------------------------

Bemessungs- spannung Rated Voltage	Artikel Article	Bemessungsstrom Rated Current	Länge L Length L	Durchmesser D Diameter D
kV		A	mm	mm
10/17,5	30 373 11	1 - 5	340	39,6

Bemessungs- strom Rated Current	Artikel Nr. Article No.	Gewicht Weight	Bemessungs- ausschaltstrom Rated Breaking Current - I ₁	Minimaler Ausschaltstrom Min. Breaking Current - I ₃	Schmelzintegral Pre-Arcing- I ² t-Value	Ausschaltintegral Total I ² t-Value	Leistungsabgabe Power Loss
A		kg/1	kA	A	A ² s	A ² s	W
1	30 373 11.1	1,1	63	8	0,6	1,9	7,4
2	30 373 11.2	1,1	63	16	3,2	9,9	13
3	30 373 11.3	1,1	63	24	16,1	47,8	15
4	30 373 11.4	1,1	63	32	28,9	85,3	20
5	30 373 11.5	1,1	63	40	40,9	120,7	24

10/17,5 kV L = 340 mm

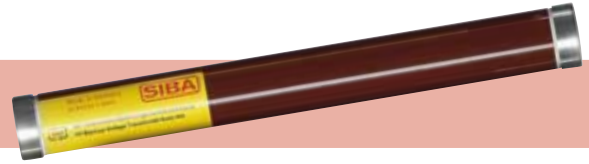

Zeit/Strom-Kennlinie
Time-current characteristic

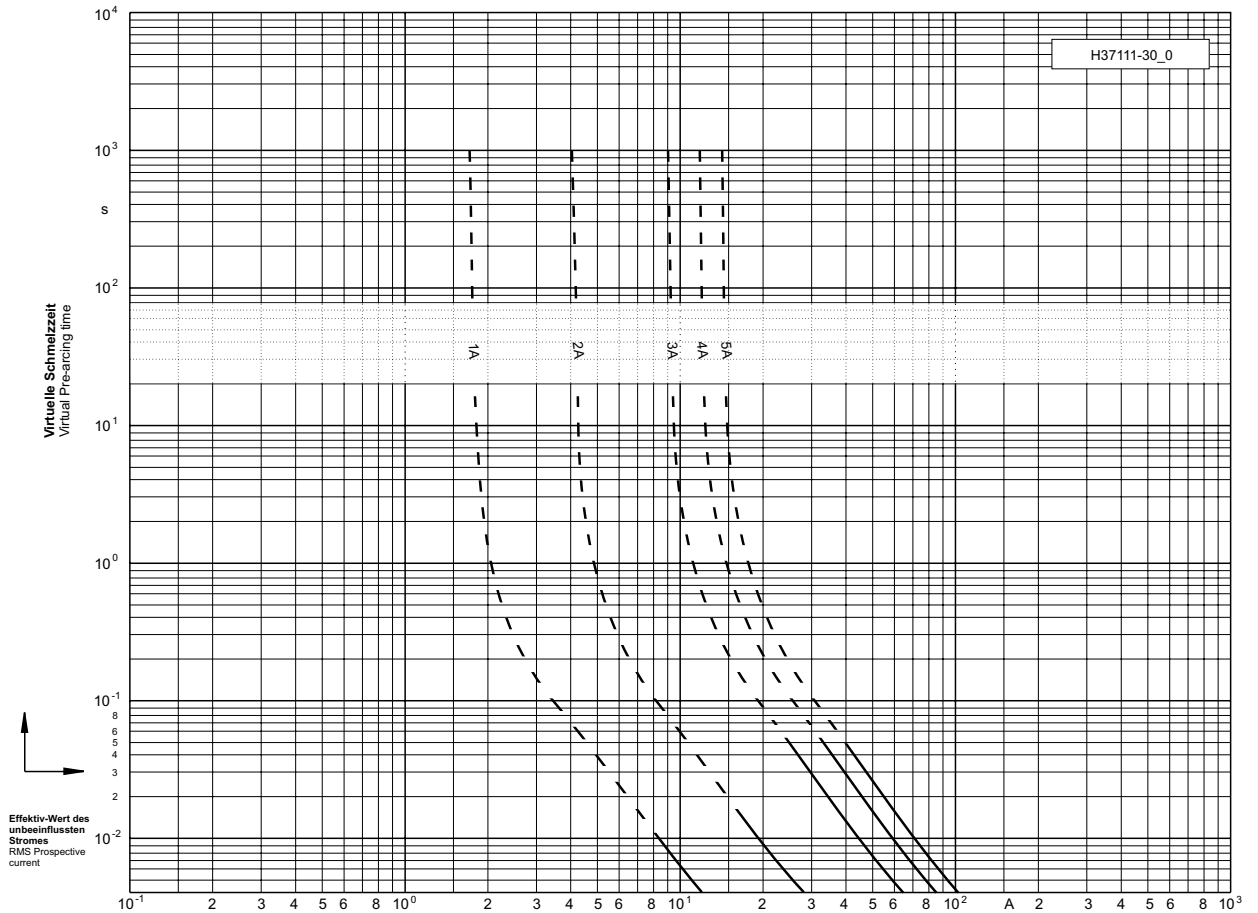

Durchlass-Strom
Cut-off current

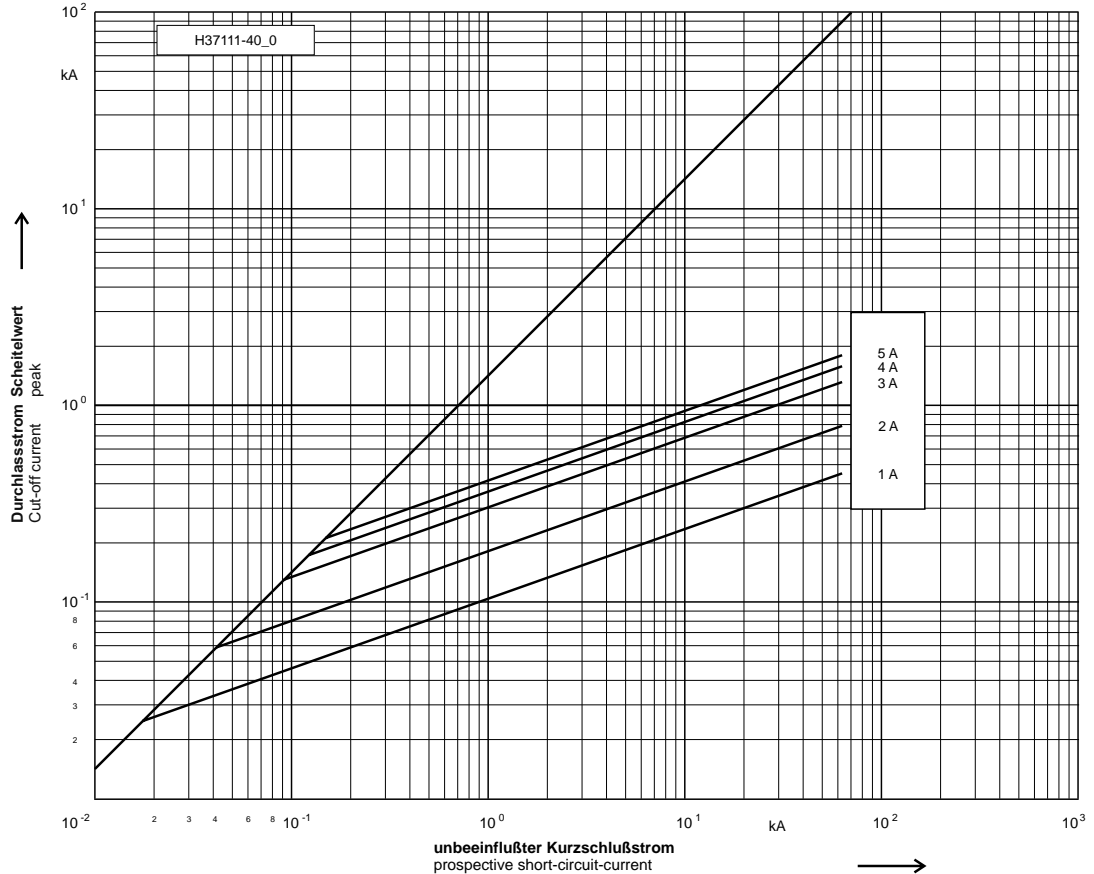

10/17,5 kV L = 220 mm

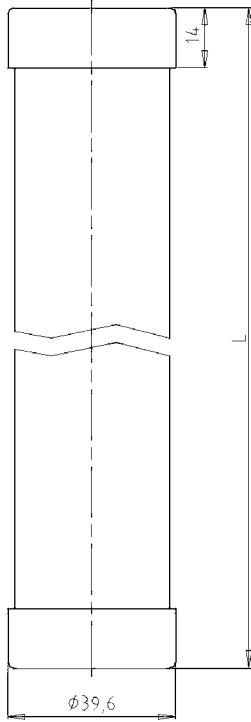

Einsatz / Application

Für den Schutz von Spannungswandlern / For voltage transformer protection

Verpackung / Packing 1 Stück / 1 piece

Betriebsklasse / Class Teilbereich / Back-up	Werksnorm	Company Standard
---	-----------	---------------------

Bemessungs- spannung Rated Voltage	Artikel Article	Bemessungsstrom Rated Current	Länge L Length L	Durchmesser D Diameter D
kV		A	mm	mm
10/17,5	30 444 11	1 - 3	220	39,6

Bemessungs- strom Rated Current	Artikel Nr. Article No.	Gewicht Weight	Bemessungs- ausschaltstrom Rated Breaking Current - I ₁	Minimaler Ausschaltstrom Min. Breaking Current - I ₃	Schmelzintegral Pre-Arcing- I ² t-Value	Ausschaltintegral Total I ² t-Value	Leistungsabgabe Power Loss
A		kg/1	kA	A	A ² s	A ² s	W
1	30 344 11.1	0,7	63	8	0,6	1,9	7,4
2	30 344 11.2	0,7	63	16	3,2	9,9	13
3	30 344 11.3	0,7	63	24	16,1	47,8	15

10/17,5 kV L = 220 mm



Zeit/Strom-Kennlinie
Time-current characteristic

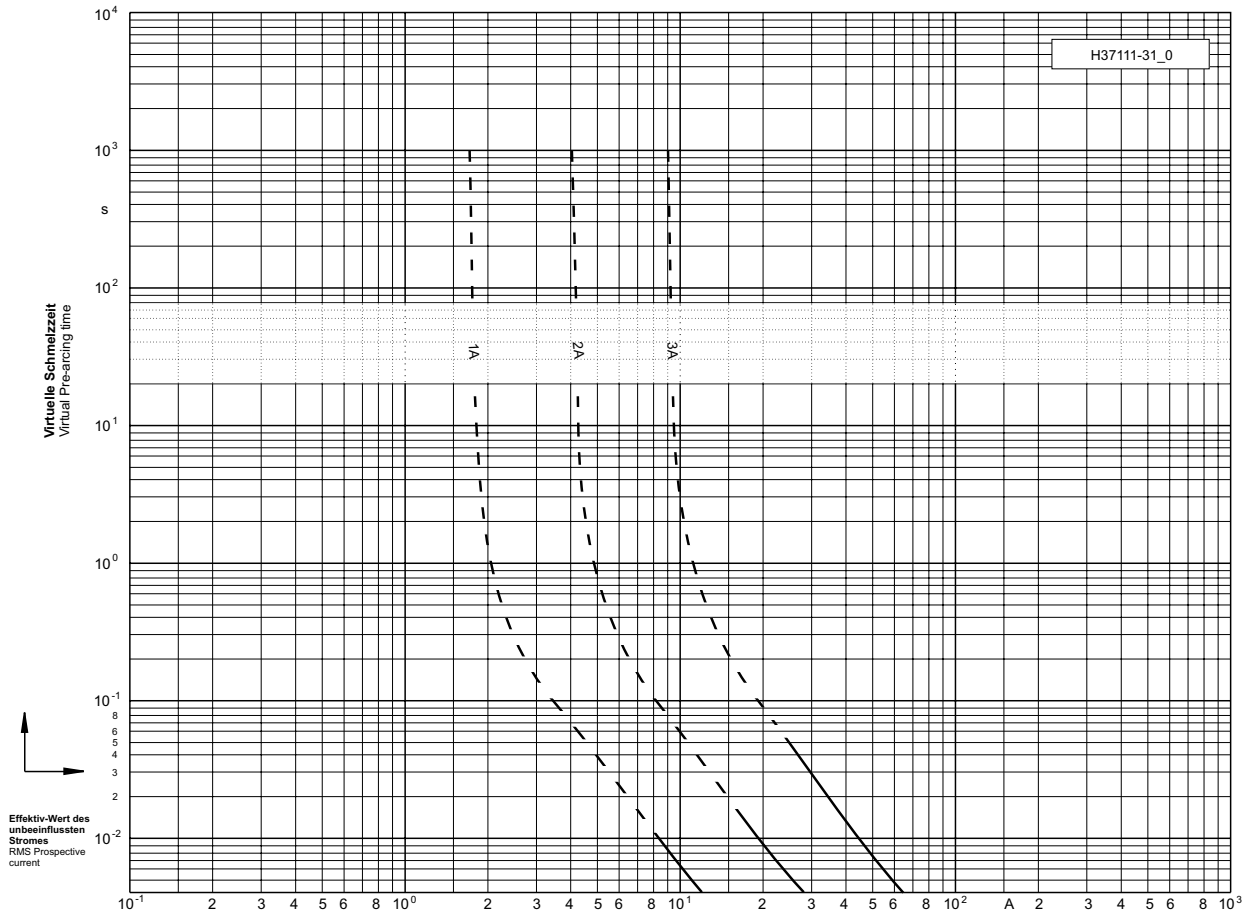

Durchlass-Strom
Cut-off current

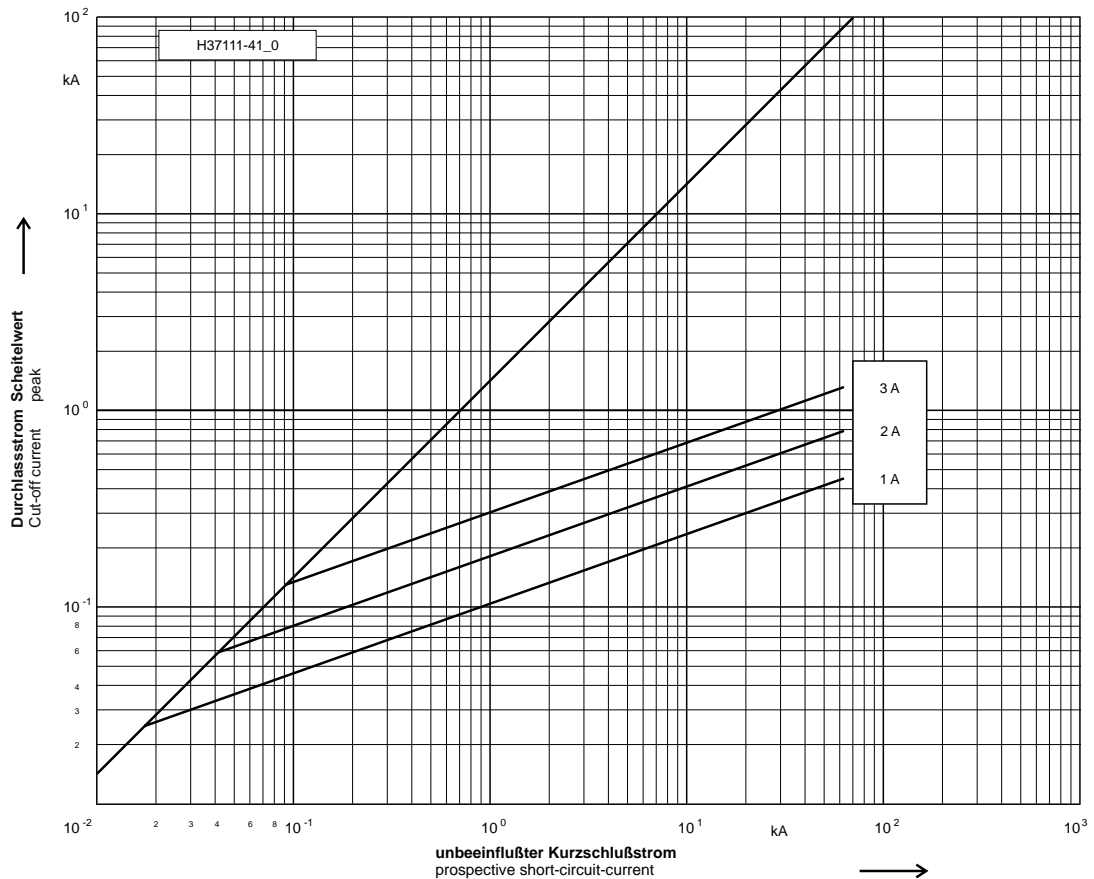

10/17,5 kV L = 359 mm

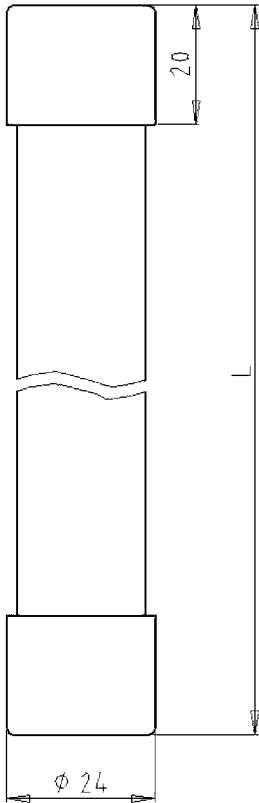
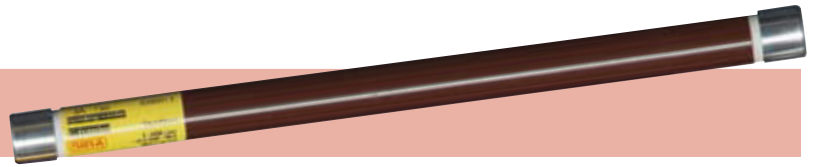

Einsatz / Application

Für den Schutz von Spannungswandlern / For voltage transformer protection

Verpackung / Packing 1 Stück / 1 piece

Betriebsklasse / Class Teilbereich / Back-up	Werksnorm	Company Standard
---	-----------	------------------

Bemessungs- spannung Rated Voltage	Artikel Article	Bemessungsstrom Rated Current	Länge L Length L	Durchmesser D Diameter D
kV		A	mm	mm
10/17,5	30 379 11	1 - 3	359	24

Bemessungs- strom Rated Current	Artikel Nr. Article No.	Gewicht Weight	Bemessungs- ausschaltstrom Rated Breaking Current - I ₁	Minimaler Ausschaltstrom Min. Breaking Current - I ₃	Schmelzintegral Pre-Arcing- I ² t-Value	Ausschaltintegral Total I ² t-Value	Leistungsabgabe Power Loss
A		kg/1	kA	A	A ² s	A ² s	W
1	30 379 11.1	0,8	63	8	0,6	1,9	8
2	30 379 11.2	0,8	63	16	3,2	9,9	13
3	30 379 11.3	0,8	63	24	16,1	47,8	16

10/17,5 kV L = 359 mm

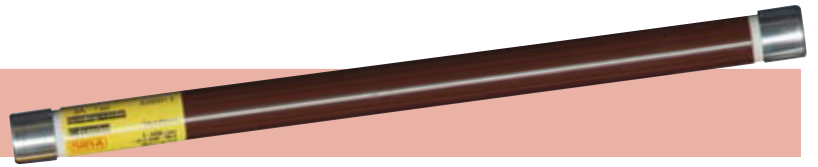

Zeit/Strom-Kennlinie
Time-current characteristic

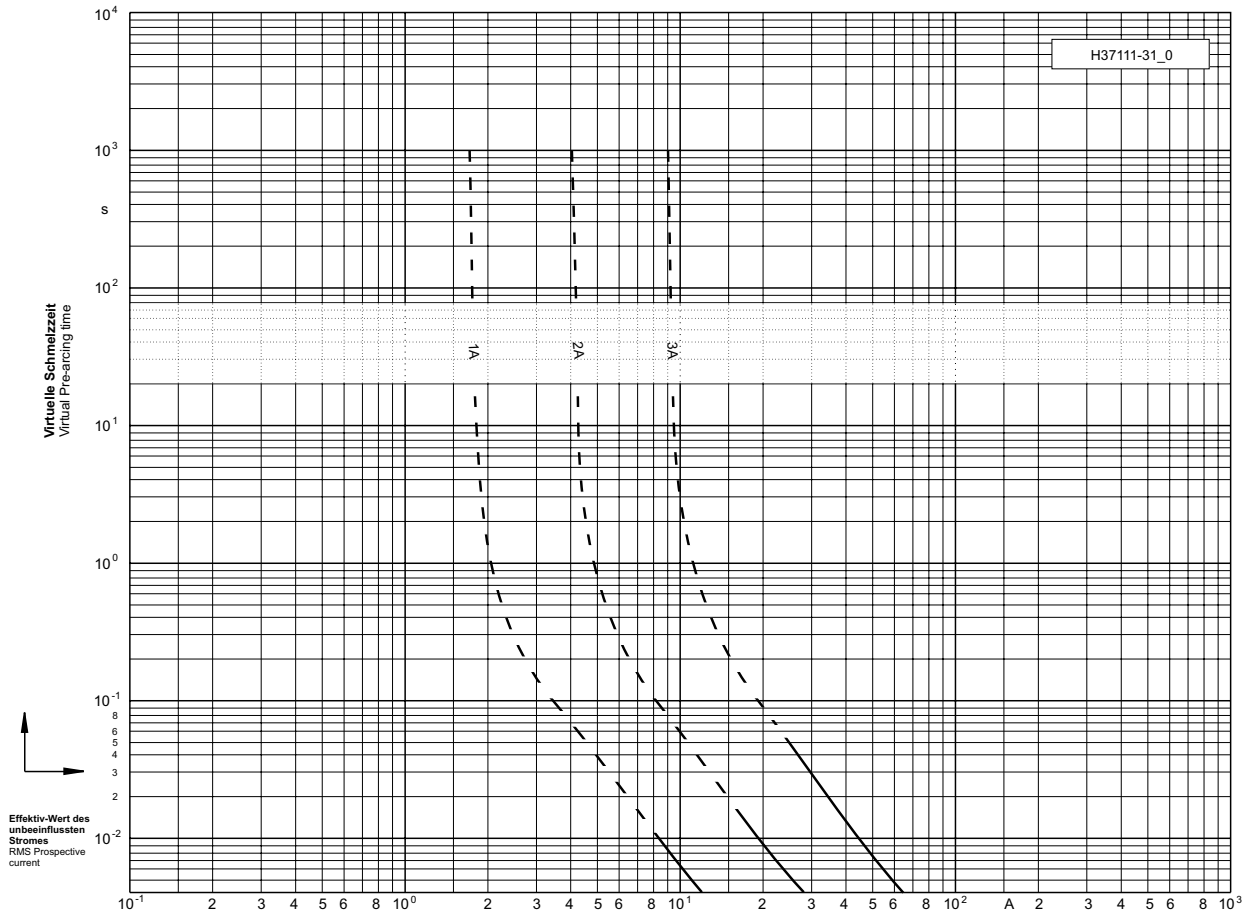

Durchlass-Strom
Cut-off current

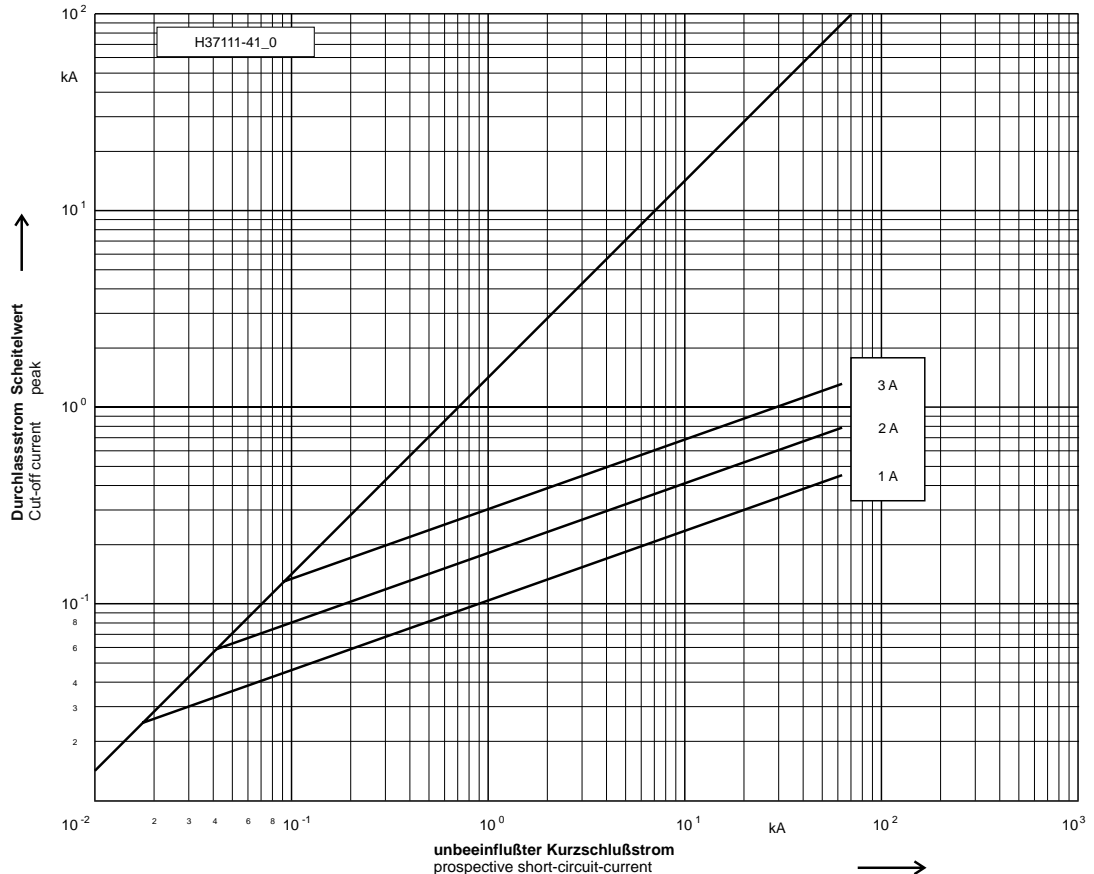

10/24 kV L = 340 mm

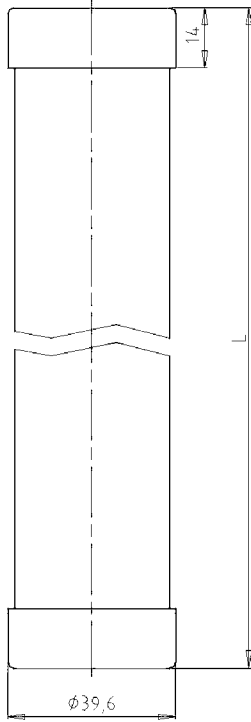
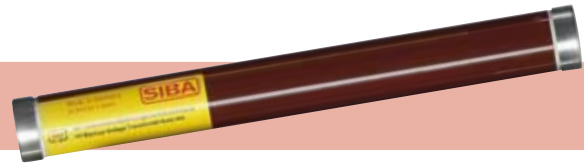

Einsatz / Application

Für den Schutz von Spannungswandlern / For voltage transformer protection

Verpackung / Packing 1 Stück / 1 piece

Betriebsklasse / Class Teilbereich / Back-up	Werksnorm	Company Standard
---	-----------	---------------------

Bemessungs- spannung Rated Voltage	Artikel Article	Bemessungsstrom Rated Current	Länge L Length L	Durchmesser D Diameter D
kV		A	mm	mm
10/24	30 374 11	1 - 5	340	39,6

Bemessungs- strom Rated Current	Artikel Nr. Article No.	Gewicht Weight	Bemessungs- ausschaltstrom Rated Breaking Current - I ₁	Minimaler Ausschaltstrom Min. Breaking Current - I ₃	Schmelzintegral Pre-Arcing- I ² t-Value	Ausschaltintegral Total I ² t-Value	Leistungsabgabe Power Loss
A		kg/1	kA	A	A ² s	A ² s	W
1	30 374 11.1	1,1	63	8	0,6	1,9	9
2	30 374 11.2	1,1	63	16	3,2	9,9	15
3	30 374 11.3	1,1	63	24	16,1	47,8	17
4	30 374 11.4	1,1	63	32	28,9	85,3	26
5	30 374 11.5	1,1	63	40	40,9	120,7	31

10/24 kV L = 340 mm

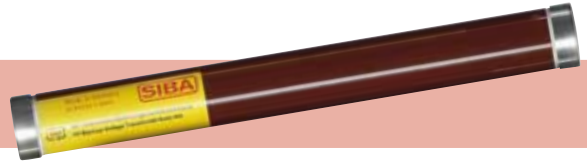

Zeit/Strom-Kennlinie
Time-current characteristic

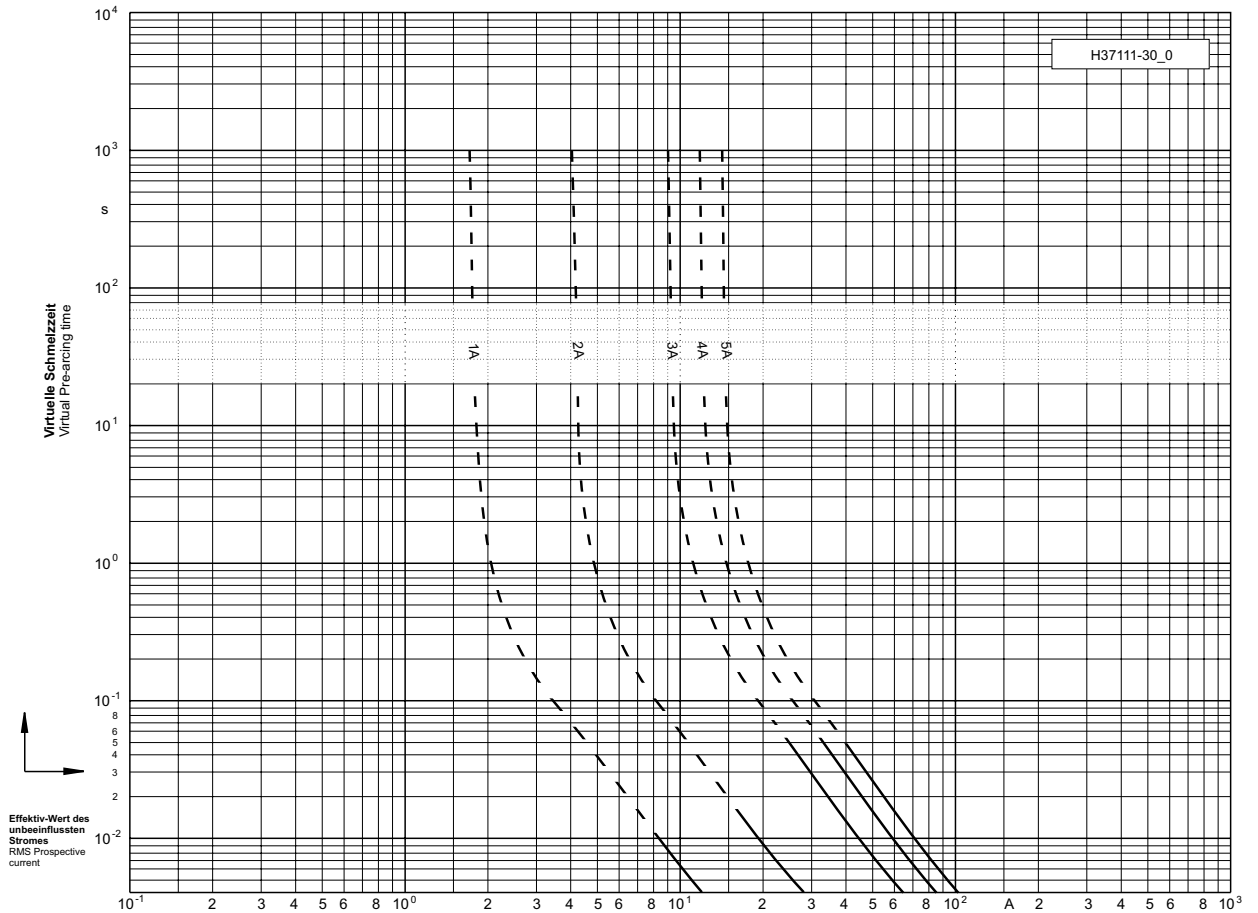

Durchlass-Strom
Cut-off current

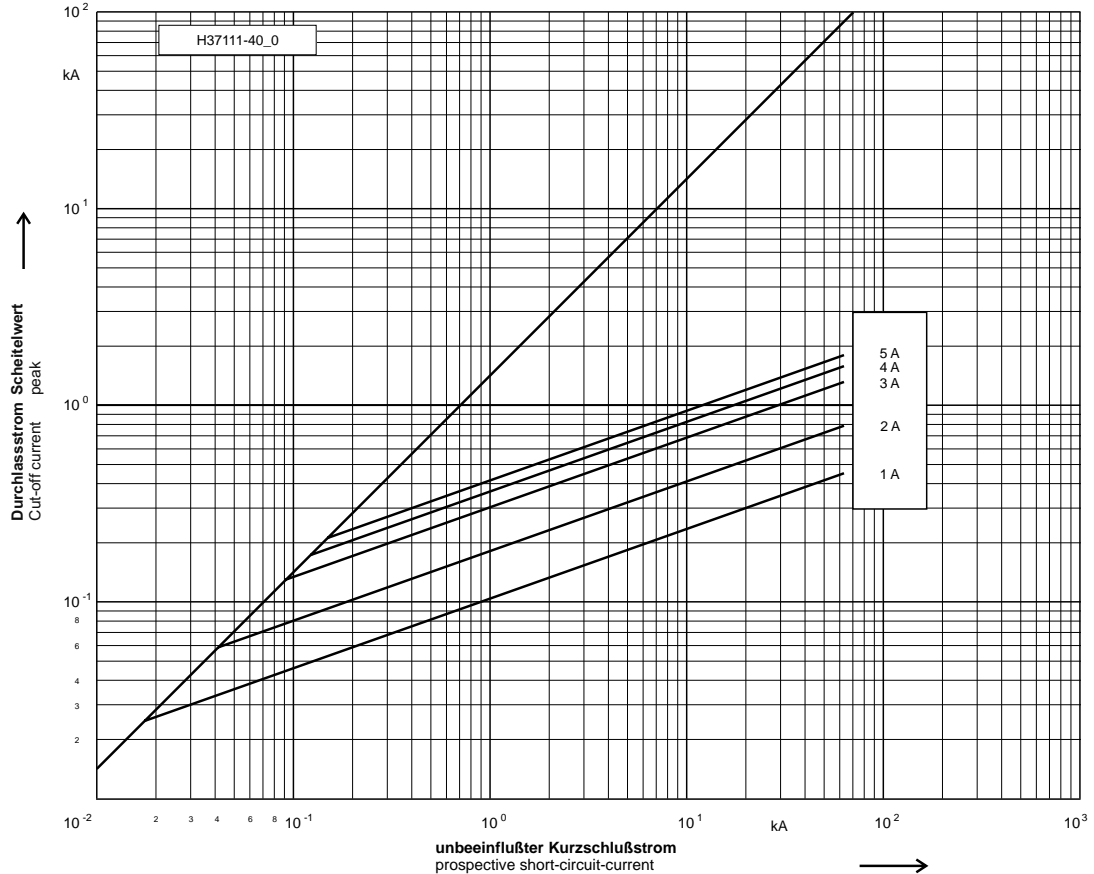

10/24 kV L = 359 mm

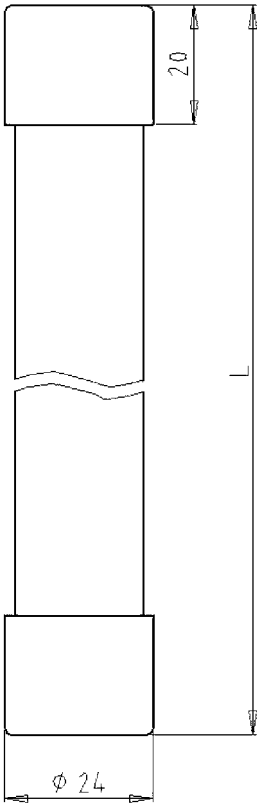
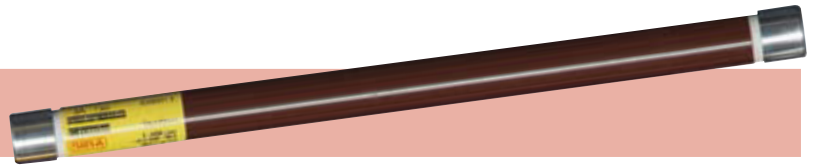

Einsatz / Application

Für den Schutz von Spannungswandlern / For voltage transformer protection

Verpackung / Packing 1 Stück / 1 piece

Betriebsklasse / Class Teilbereich / Back-up	Werksnorm	Company Standard
---	-----------	---------------------

Bemessungs- spannung Rated Voltage	Artikel Article	Bemessungsstrom Rated Current	Länge L Length L	Durchmesser D Diameter D
kV		A	mm	mm
10/24	30 380 11	1 - 3	359	24

Bemessungs- strom Rated Current	Artikel Nr. Article No.	Gewicht Weight	Bemessungs- ausschaltstrom Rated Breaking Current - I ₁	Minimaler Ausschaltstrom Min. Breaking Current - I ₃	Schmelzintegral Pre-Arcing- I ² t-Value	Ausschaltintegral Total I ² t-Value	Leistungsabgabe Power Loss
A		kg/1	kA	A	A ² s	A ² s	W
1	30 380 11.1	0,8	63	8	0,6	1,9	10
2	30 380 11.2	0,8	63	16	3,2	9,9	16
3	30 380 11.3	0,8	63	24	16,1	47,8	18

10/24 kV L = 359 mm

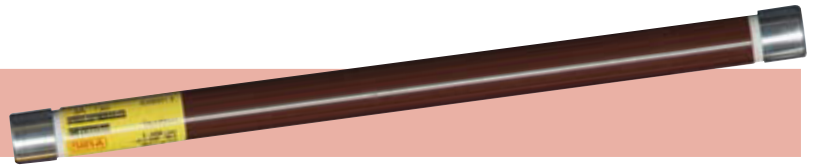

Zeit/Strom-Kennlinie
Time-current characteristic

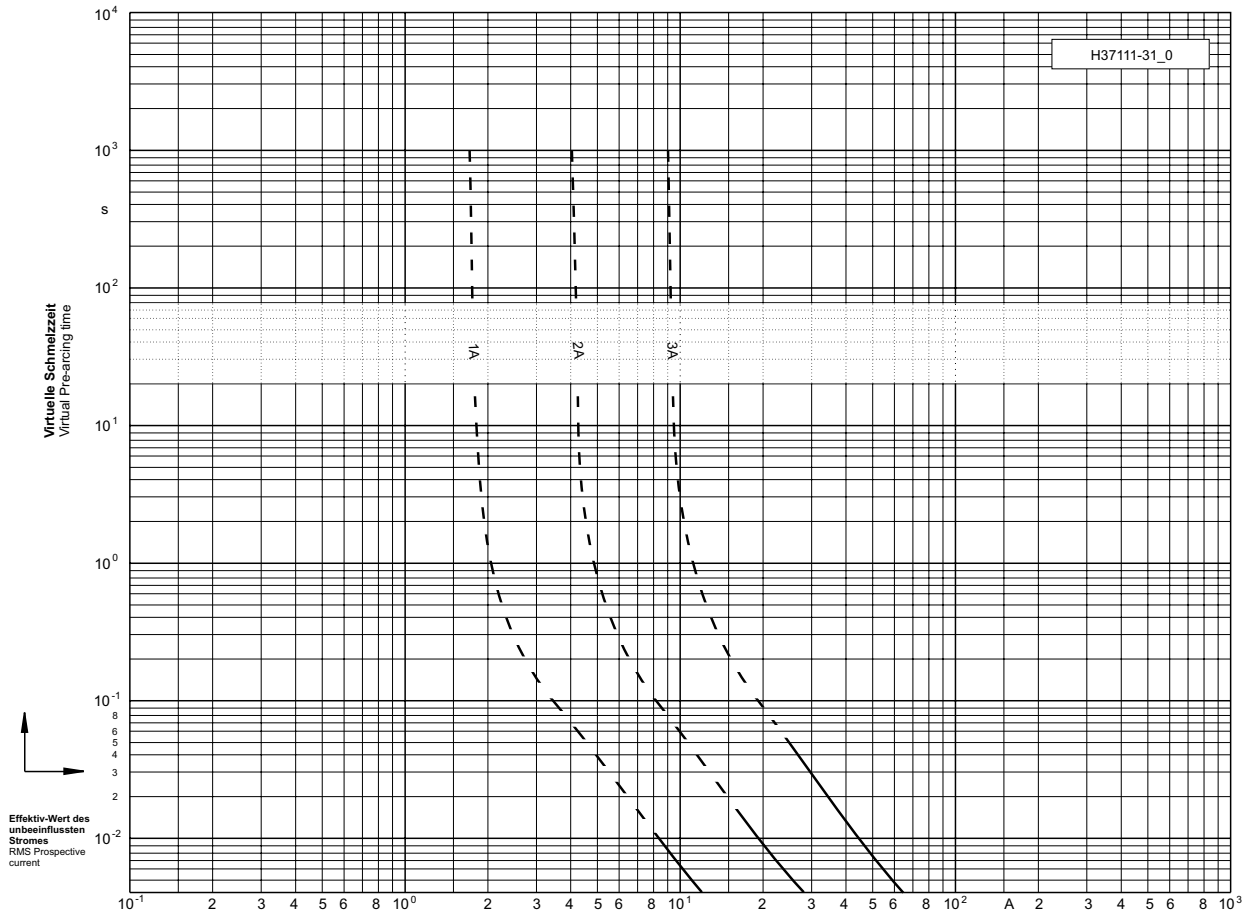

Durchlass-Strom
Cut-off current

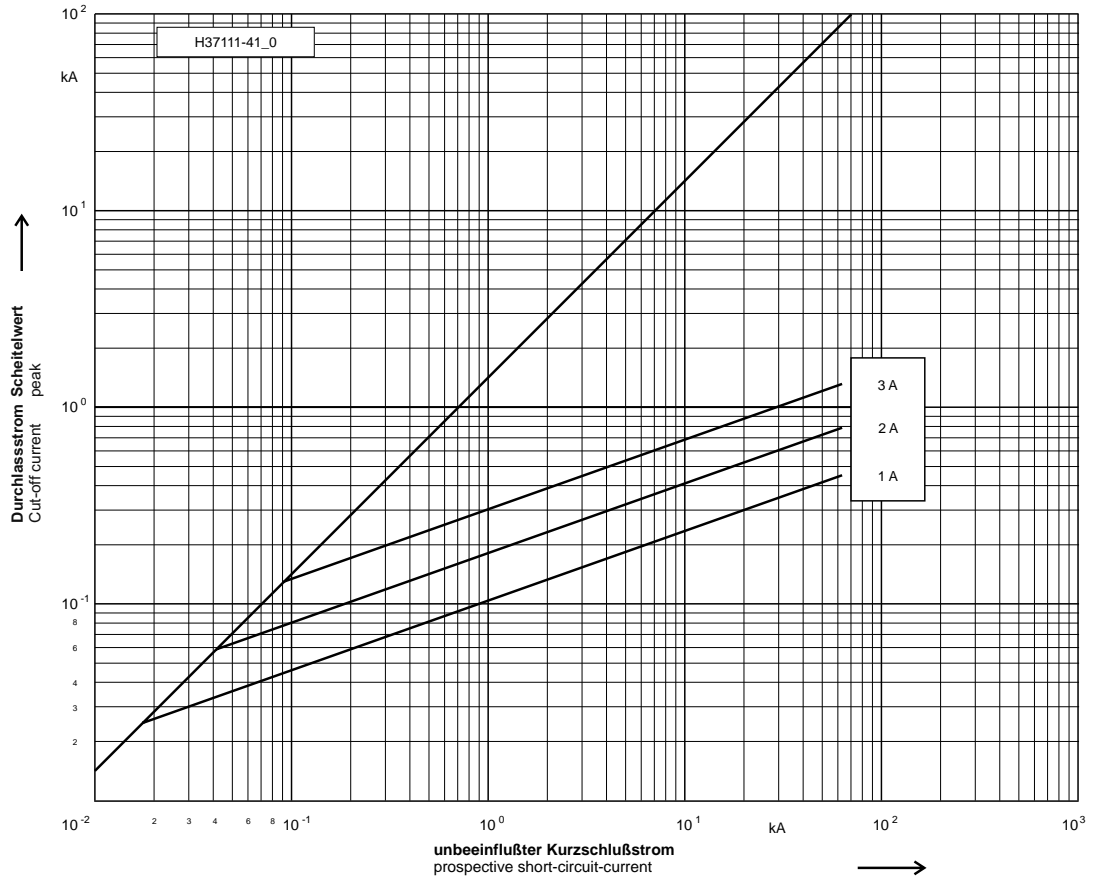

20/36 kV L = 440 mm

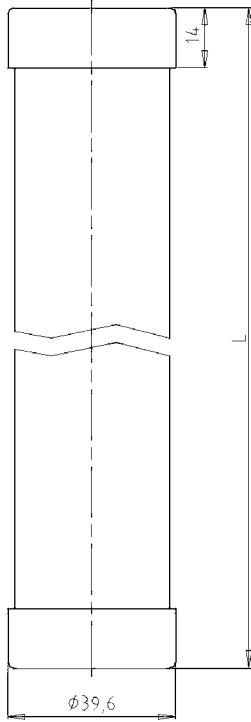

Einsatz / Application

Für den Schutz von Spannungswandlern / For voltage transformer protection

Verpackung / Packing 1 Stück / 1 piece

Betriebsklasse / Class Teilbereich / Back-up	Werksnorm	Company Standard
---	-----------	------------------

Bemessungs- spannung Rated Voltage	Artikel Article	Bemessungsstrom Rated Current	Länge L Length L	Durchmesser D Diameter D
kV		A	mm	mm
20/36	30 375 11	1 - 3	440	39,6

Bemessungs- strom Rated Current	Artikel Nr. Article No.	Gewicht Weight	Bemessungs- ausschaltstrom Rated Breaking Current - I ₁	Minimaler Ausschaltstrom Min. Breaking Current - I ₃	Schmelzintegral Pre-Arcing- I ² t-Value	Ausschaltintegral Total I ² t-Value	Leistungsabgabe Power Loss
A		kg/1	kA	A	A ² s	A ² s	W
1	30 375 11.1	1,2	63	8	0,6	1,9	14
2	30 375 11.2	1,2	63	16	3,2	9,9	23
3	30 375 11.3	1,2	63	24	16,1	47,8	26

20/36 kV L = 440 mm



Zeit/Strom-Kennlinie
Time-current characteristic

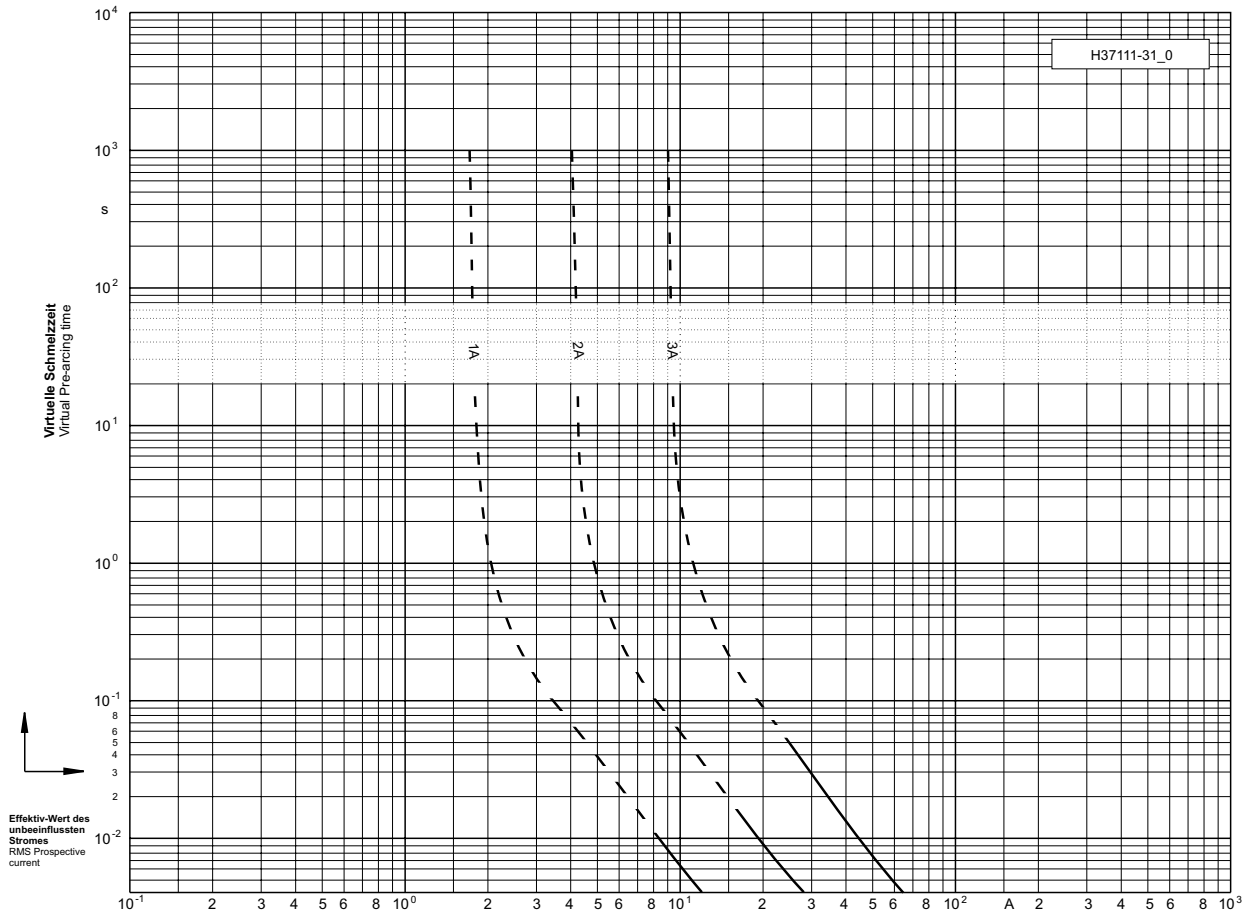

Durchlass-Strom
Cut-off current

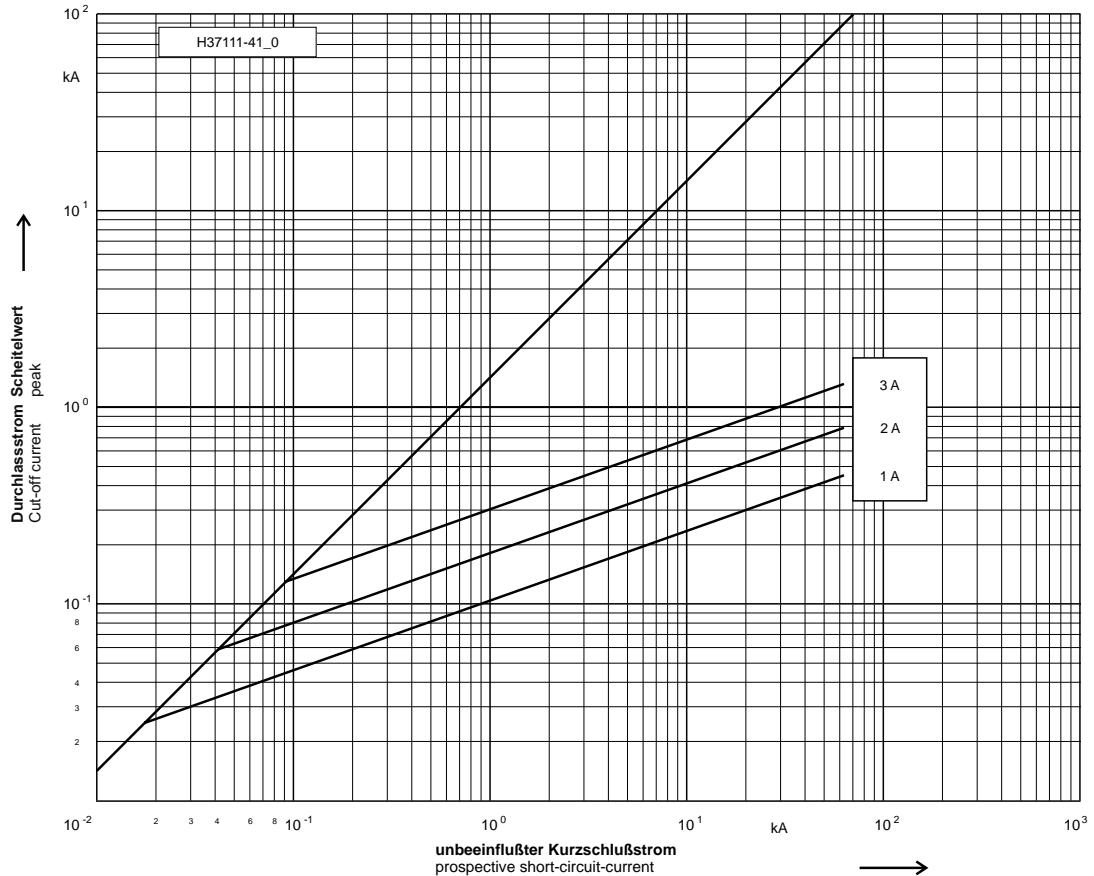

20/36 kV L = 359 mm

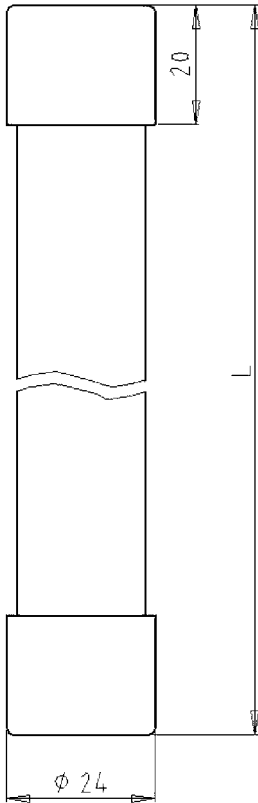
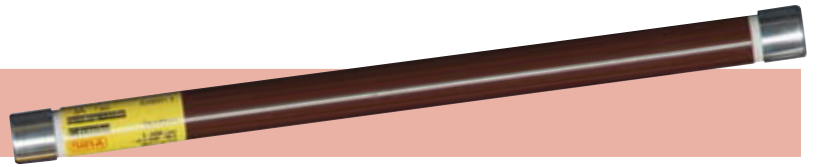

Einsatz / Application

Für den Schutz von Spannungswandlern / For voltage transformer protection

Verpackung / Packing 1 Stück / 1 piece

Betriebsklasse / Class Teilbereich / Back-up	Werksnorm	Company Standard
---	-----------	---------------------

Bemessungs- spannung Rated Voltage	Artikel Article	Bemessungsstrom Rated Current	Länge L Length L	Durchmesser D Diameter D
kV		A	mm	mm
20/36	30 381 11	1 - 3	359	24

Bemessungs- strom Rated Current	Artikel Nr. Article No.	Gewicht Weight	Bemessungs- ausschaltstrom Rated Breaking Current - I ₁	Minimaler Ausschaltstrom Min. Breaking Current - I ₃	Schmelzintegral Pre-Arcing- I ² t-Value	Ausschaltintegral Total I ² t-Value	Leistungsabgabe Power Loss
A		kg/1	kA	A	A ² s	A ² s	W
1	30 381 11.1	0,8	63	8	0,6	1,9	15
2	30 381 11.2	0,8	63	16	3,2	9,9	24
3	30 381 11.3	0,8	63	24	16,1	47,8	28

20/36 kV L = 359 mm

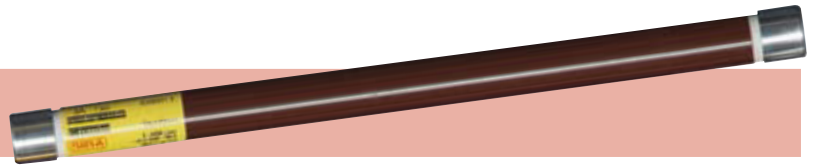

Zeit/Strom-Kennlinie
Time-current characteristic

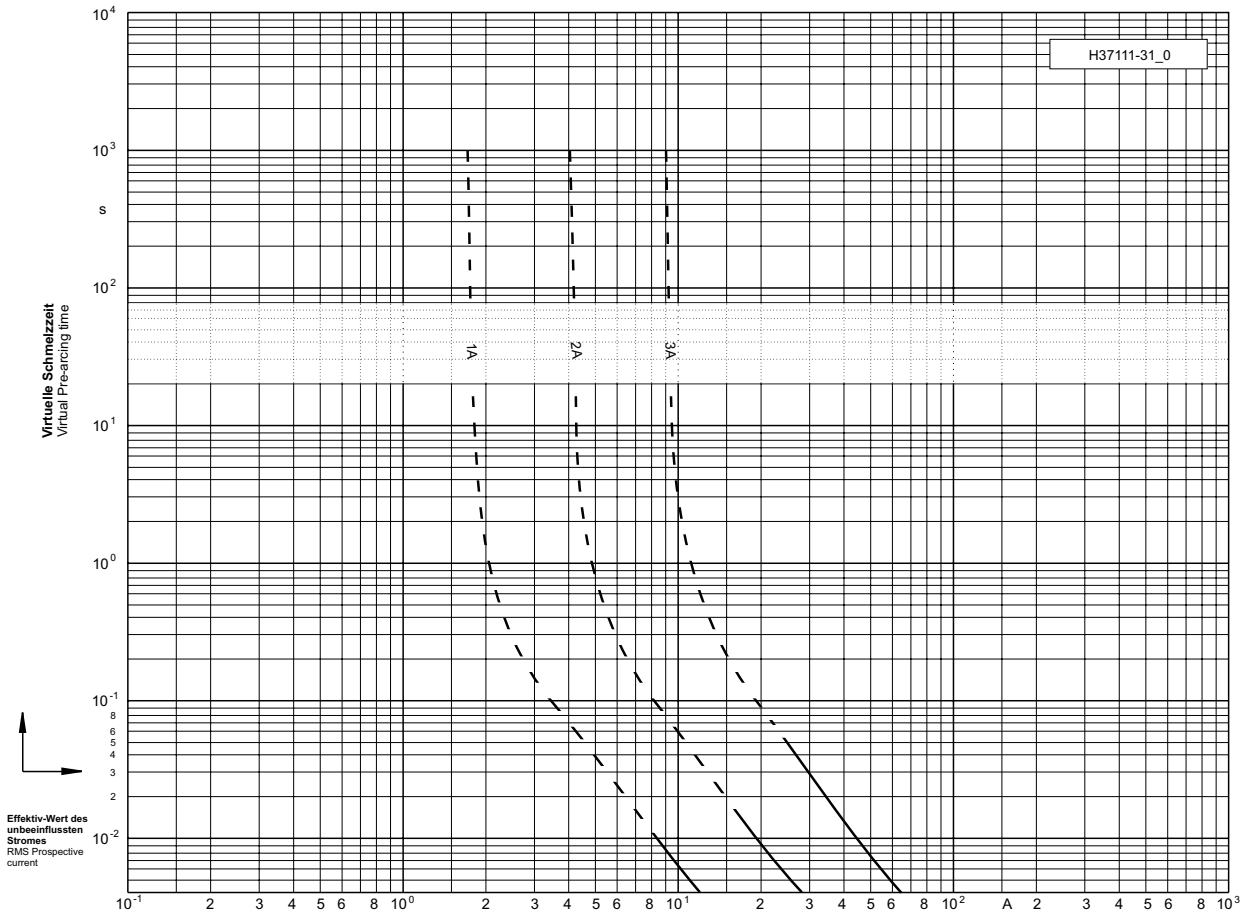

Durchlass-Strom
Cut-off current

