



POWER FACTOR CORRECTION

POWER QUALITY

ENERGY MANAGEMENT



DATA COLLECTION



DATA PROCESSING



SOLUTIONS



POWER QUALITY



FRAKO – Leading-edge technology for safe and reliable network solutions

FRAKO's mission is to provide solutions that are designed and optimized to meet the needs of our customers. Our accumulated experience and our expertise in development and manufacture are applied to achieve this. The operational reliability of our products is as well known internationally as our track record in developing new solutions.

Every sphere, every activity and every operation of our company is hallmarked by quality. This bears fruit in FRAKO's renowned product quality as well as the quality of our advisory and field services. We value reliability, punctuality and transparency with the same commitment we have for durability and performance. This is why FRAKO today leads the entire world in its areas of business:

- High quality capacitors
- Individually specified power factor correction systems
- Efficient power quality solutions
- Intelligent Energy Management Systems
- Dependable customer service before and after sales

Our customers and business partners know that: FRAKO means quality, and that quality means safety and reliability. Because of this we can shoulder the responsibility for the correct functioning, profitability and environmental compatibility of our products and can guarantee their safety to life, limb and property. We are in a position to fulfil the most demanding requirements and develop innovative solutions to suit individual needs.

Our excellently trained and motivated employees have the technical competence and in-depth expertise to design and implement new installations successfully. We ourselves also take particular care to ensure that energy is used sparingly and efficiently in the manufacture and operation of our products. Our own energy consumption and the emissions generated are continually monitored with our in-house Energy Management System to ensure that we achieve the highest levels of energy efficiency and environmental compatibility.

For the future we are committed to an ongoing and intensive effort to maintain our leading position and to justify the trust placed in us by our customers in the fields of power quality, energy cost minimization and energy efficiency.

At FRAKO we look forward to developing, manufacturing and supplying innovative and productive systems for our customers and business partners in the future.

Dr. Matthias Sehmsdorf

QUALITY means safety and reliability

Exacting and ever more demanding quality specifications in all areas are the criteria for our products and services.

A particularly important role in meeting this challenge is our individual advisory and project planning. The basis for our successful cooperation with our customers is given by our certified quality and environmental management systems and our own research and development departments. On top of this we always adhere to our guiding principles that make us a straightforward and agreeable partner to work with. You can always take us at our word; for us that is as much a matter of course as being able to deliver, delivering on time and reacting promptly to handle any complaints.

As a supplier of complete systems, we pay attention to the quality and good working order of every individual component. In this way we achieve the high profitability and increased service life of our installations and systems. We fulfil the most exacting requirements in all areas: when advising customers, honouring commitments and turning individual needs into concrete products and special services.

FRAKO POWER CAPACITORS

FRAKO power capacitors offer 'Made in Germany' quality and form the optimum basis for both fixed installed capacitance for specific duties and controlled power factor correction systems. Our power capacitors incorporate a fourfold safety system for maximum operational reliability. They are the first choice when consumers worldwide need to reduce reactive power, improve power quality and avoid charges for reactive demand.

Distinct advantages of our power capacitors:

- High overload capability
- Long service life
- Maximum operational reliability

FRAKO's patented power capacitors are lead-free because of the patented contact ring and comply with the RoHS Directive. They are available in Basic, Standard, Premium and Heavy Duty versions, so that you can specify the ideal power capacitor for your individual requirements in terms of ampacity, ambient temperature and expected service life.

POWER QUALITY & POWER FACTOR CORRECTION

Poor power quality in the supply network can result in upsets or even failure in technical equipment and installations. FRAKO power quality products offer the right solution to maintain the quality of the power supply at a high level.

FRAKO's power factor correction and filter systems are individually designed for the user, as are our active harmonic filters.

They are installed at those locations where electrical energy is to be saved, voltage fluctuations avoided and harmonics eliminated, or simply where reactive power must be compensated.

ENERGY MANAGEMENT SYSTEMS

FRAKO Energy Management Systems help your company to cut costs and achieve energy efficiency.

The FRAKO Energy Management System supplies the optimum basis for all decisions to be made in optimizing energy consumption. With a FRAKO Energy Management System in place, the flow of utilities in the company is made transparent, their costs can be clearly allocated and accurately charged for, and approaches to saving energy become much easier to identify.

CUSTOMER SERVICES

FRAKO's range of services offers a comprehensive program for achieving high energy efficiency and availability.

Particular importance is attached to the individual advisory and training services offered to our customers, special inspection and maintenance contracts and customized project execution. Every solution that we propose to our customers is based on detailed network measurement readings and an in-depth analysis of the status quo and individual requirements.

POWER FACTOR CORRECTION

Page 6



POWER QUALITY

Page 152



ENERGY MANAGEMENT

Page 226



POWER FACTOR CORRECTION



POWER FACTOR CORRECTION

Components

Page 8



1

PFC Capacitors in sheet steel cases

Page 52



2

PFC Systems on mounting plates / Capacitor Modules

Page 66



3

Accessory equipment for PFC Systems and modules

Page 86

4

PFC Systems

Page 100



5

Technical Annex

Page 136

6

1 Components

Power Capacitors and accessories

Page 9

Basic and Standard Harmonic Filter Reactors

Page 21

Basic Harmonic Filter Reactors

Page 23

Standard Harmonic Filter Reactors

Page 27

Power Factor Control Relays

Page 35

Power Quality Controller

Page 39

Capacitor Switching Contactors for Power Factor Correction Systems with or without reactors

Page 45

Discharge Reactors

Page 49

Components

Power Capacitors and accessories



1

LKT Power Capacitors

FRAKO Power Capacitors are installed in power factor correction systems and in passive filters.

FRAKO Power Capacitors have been developed and manufactured for decades solely at the company's Teningen production site in Germany. This has resulted in a consistently high product quality being maintained, the basis for assured operational reliability and a long service life.

Application Recommendations

FRAKO offers Power Capacitors for a variety of applications. They are divided into four separate categories with different specifications:

- Basic Capacitors
- Standard Capacitors
- Premium Capacitors
- Heavy Duty Capacitors

FRAKO Power Capacitors with **UL/CSA certification:**

Please contact us if you require information on our UL/CSA series of Power Capacitors.

FRAKO Power Capacitors are available as single-phase and 3-phase versions.

Voltage and power ranges:

- Nominal voltage: 240–800 V, 50 / 60 Hz
- Nominal power: 1.0–40.0 kvar

Components

Power Capacitors and accessories

1

Design & quality

FRAKO Power Capacitors are manufactured in a unique dry design. Each comprises up to three interconnected capacitor coils wound in a low-loss, metallized polypropylene film and enclosed in a cylindrical aluminium casing provided with an M12 mounting stud. In addition to a PCB-free, flame-resistant mineral filler material, the casings also contain an adhesive stabilizer. Discharge resistors, permanently connected in the factory, guarantee that the residual voltage falls to <50 V within one minute after the capacitor has been disconnected. Cables are connected by means of the tried-and-tested spring clamps of the AKD range, which are 'finger-safe' and maintenance-free.

The use of rigorously inspected materials and their careful processing guarantee excellent quality and a long product service life. FRAKO manufactures its Power Capacitors to its own in-house specifications, which are far more exacting than the requirements of the applicable standards.

Quality control inspections after each individual manufacturing step ensure that the final product is of a high quality. These demanding quality standards, together with specially developed manufacturing technology, enable FRAKO Power Capacitors to achieve a longer-than-average service life. At the end of the manufacturing process, each capacitor is inspected individually. The in-house requirements for this special inspection are considerably more stringent than those of the routine tests specified by the relevant standards.

Standards

All FRAKO Power Capacitors comply with the international standards IEC 60831-1 and -2, and of course with EN 60831 1 and -2. In addition, a special series developed for the North American market complies with the requirements of UL 810 and CSA 22.2 No. 190.

Four safety features ensure uninterrupted operation

The reliability of Power Capacitors is crucially important for the problem-free operation of power factor correction systems and passive filters. FRAKO's measures to ensure this are now fourfold: Power Capacitors nowadays usually use polypropylene as the dielectric material, its surfaces being metallized. This design has the important property that if local overloading occurs and punctures the substrate film, the fault automatically isolates itself, a phenomenon known as **self-healing**.

Self-healing is due to the heavy short-circuit current that flows between the films immediately vaporizing the very thin metal coating at the damaged location, thus ending the flow of current.



If several punctures occur in a small area of metallized film, the amount of energy involved might be too much for the **self-healing** action alone to cope with. This could lead to complete failure of the capacitor. However, in this case the second fail-safe function of the fourfold safety design comes into play: the **segmented metallization**.

In the manufacturing process, the polypropylene film for FRAKO Power Capacitors is metallized by vapour deposition to form a pattern of separate individual segments. Each segment is connected to the power supply by slender contact bridges, these being so dimensioned that when severely overloaded (several substrate punctures within one segment), they act as fuses by simply vaporizing, thereby securely isolating the damaged segment from the power supply.



The **segmented metallization** technique increases the reliability of the capacitors and prolongs their service life.

Components

Power Capacitors and accessories

The third design feature for increases product safety is the three-phase **overpressure disconnecter**, a mechanical fuse included in every FRAKO capacitor.

If an excessive internal pressure develops due to overloading, or at the end of the capacitor's service life, the mechanical fuse isolates the capacitor safely from the power supply by disconnecting all poles. Should puncturing of the dielectric occur on a major scale, this results in the substrate film melting and generating gases inside the casing, thus building up pressure in the capacitor. This causes the diaphragm lid to bulge outwards, thereby tensioning the internal leads to the coils until they act as mechanical fuses, breaking cleanly at defined locations. The bulging of the lid also increases the internal volume, therefore reducing the pressure inside the capacitor.

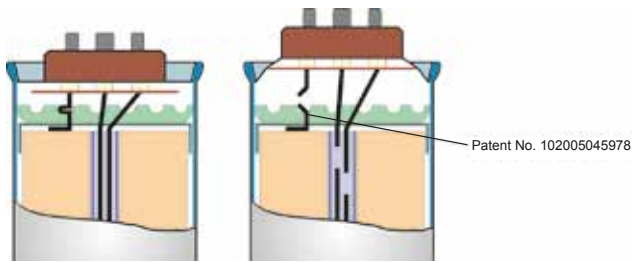

Principle of the overpressure disconnection system

In 2015, FRAKO added the patented **contact ring** to the other safety and reliability features, thus making them fourfold.

These patented rings are stamped from a special alloy and are formed with a number of pointed teeth that press into the zinc end-face contact layers on the windings to make electrical contact. The internal connecting leads are spot-welded to the **contact rings** before final assembly of the capacitor.



The great advantage of this solder-free design: it has completely excluded the risk of damaging the capacitor windings at the manufacturing stage due to overheating during soldering of the connecting leads. The quality of the winding connection is significantly increased, and the reliability of the mechanical fuse that protects against excessive internal pressure is improved by its being securely spot-welded in place.

The **contact ring** also enables FRAKO to produce completely lead-free capacitors and make yet another improvement to their operating reliability.

Special technical features

In our ongoing development work on FRAKO Power Capacitors, we always focus on those attributes that are called for in present-day applications. The three following factors are especially important:

- Overvoltage tolerance
- Current-carrying capacity
- Thermal endurance

Overvoltage tolerance

As required by the standards IEC 60831-1 & -2, as with EN 60831-1 & -2, all FRAKO Power Capacitors are designed to withstand the following overvoltages:

8 hours daily:	1.10 × capacitor nominal voltage
30 minutes daily:	1.15 × capacitor nominal voltage
5 minutes:	1.20 × capacitor nominal voltage
1 minute:	1.30 × capacitor nominal voltage

The following table shows a selection of nominal voltage ratings and maximum overvoltages:

Capacitor nominal voltage	240	400	440	480	525	600	690	760	800
8 hours daily	264	440	484	528	578	660	759	836	880
30 min daily	276	460	506	552	604	690	794	874	920
5 minutes	288	480	528	576	630	720	828	912	960
1 minute	312	520	572	624	683	780	897	988	1040

All voltages in volts [V]

Current-carrying capacity

All over the modern world, harmonics are polluting the electricity supply networks. The increasing use of devices such as frequency converters has a growing impact on capacitors. If these are operated in a power supply network contaminated by harmonics, dangerous resonances can result, which can again significantly increase the currents that the capacitors must withstand.

Components

Power Capacitors and accessories

1

The applicable standards call for a continuous current-carrying capacity of at least 1.3 times the nominal current to be designed for in Power Capacitors. In reality, however, even this value can be exceeded under conditions with extreme levels of harmonics.

For this reason, all FRAKO Power Capacitors are designed for a continuous current-carrying capacity of at least 1.5 times the nominal current. More information on ampacity is given in the specifications table on the following page.

Thermal endurance

Excessive temperatures also have a negative impact on the service life of a capacitor. Storage or operation of capacitors above their permitted temperature limits results in a drastic shortening of their service life. Power Capacitors are assigned to different temperature classes according to the permitted ambient temperature as follows:

Temperature class	Maximum ambient temperature		
	Absolute maximum temp.	Max. average temp. over 1 day	Max. average over 1 year
B	45 °C	35 °C	25 °C
C	50 °C	40 °C	30 °C
D	55 °C	45 °C	35 °C

The temperatures stated above refer to the direct environment of the capacitors. This means the internal temperature in the enclosure or control cabinet that houses them. Experience shows that the limits given in the table for the temperature classes can easily be exceeded in practice. Higher temperatures are to be expected in particular in the case of power factor correction systems fitted with filter reactors.

Power Capacitors in the Standard, Premium and Heavy Duty categories are therefore designed for continuous ambient temperatures of at least 60 °C.

This continuously rated thermal endurance is helped by the compact construction of the capacitors, which is conducive to optimum heat dissipation.

Maintenance-free capacitor connections

The connecting terminal (AKD) is based on the proven technology of the Wago Cage Clamp®. These connectors use special spring clamps that ensure a simple, vibration-resistant and maintenance-free electrical contact with the capacitor. They can be used to connect single-core, stranded or fine-filament copper cables. The AKD spring clamp complies with the IP20 rating as per EN 60529, thus qualifying as 'finger-safe'.



Components

Power Capacitors and accessories

Specifications of FRAKO Power Capacitors

Category	Basic	Standard	Premium	Heavy Duty
Type designation	LKT ...-DB	LKT ...-DP	LKT ...-DL	LKT ...-HD
Nominal voltage	400–525 V	280–800 V	400–525 V	440–615 V ¹⁾ 480–525 V
Nominal frequency	50/60 Hz			
Power rating	5.0–36 kvar	5.0–40 kvar	1.0–24 kvar	1.2–29 kvar 16.8–21.6 kvar
Capacitance tolerance ²⁾	-5 / +5 %			
Dielectric losses	0.2 W / kvar			
Power loss ³⁾	0.5 W / kvar			
Residual voltage after 60 seconds discharge time	≤50 V			
Maximum overvoltage	1.10 x V _N – 8 hours daily 1.15 x V _N – 30 minutes daily 1.20 x V _N – 5 minutes 1.30 x V _N – 1 minute			
Maximum continuous overcurrent at nominal voltage (50 Hz)	1.5 x I _N	1.8 x I _N	2.2 x I _N	2.0 x I _N 2.7 x I _N
Maximum inrush current at nominal voltage (50 Hz)	200 x I _N	250 x I _N	300 x I _N	272 x I _N 450 x I _N
Test voltage (metal film–metal film)	2.15 x V _N , 2 seconds 1.85 x V _N , 10 seconds			
Test voltage (metal film–casing)	V _N < 600 V = 3.9 kV, 2 seconds V _N > 600 V = 4.3 kV, 2 seconds			
Insulation voltage rating dependent on V _N and diameter	3.9 / 8 kV 3.9 / 12 kV 4.3 / 8 kV 4.3 / 12 kV			
Temperature class	-25 / D	-40 / 60	-40 / 65	-40 / 60 -40 / 68
Min. / max. temperature ⁴⁾	-25 / +55 °C	-40 / +60 °C	-40 / +65 °C	-40 / +60 °C -40 / +68 °C
Max. casing temperature	+70 °C	+75 °C	+78 °C	+75 °C +78 °C
Min. / max. storage temperature	-25 / +85 °C	-40 / +85 °C		
Max. humidity	95 % non-condensing			
Max. site altitude	4 000 metres			
Service life	100 000 h	130 000 h	170 000 h	130 000 h 200 000 h
Max. number of switching cycles per year	20 000	40 000	60 000	40 000 100 000

¹⁾ Capacitors of the Premium category can be operated above their nominal voltage if a reduced specification is acceptable. The tables on pages 18 and 19 give the maximum permissible continuous overvoltage for each capacitor type.

²⁾ Other tolerances on request

³⁾ Total power loss incl. discharge resistor

⁴⁾ The table of temperature classes on the previous page applies to capacitors of the Basic category. Capacitors of the categories Standard, Premium and Heavy Duty are specified for continuous operation at the stated maximum temperature.

Components

Power Capacitors and accessories

Basic Capacitors (three-phase, V_N : 400 V...525 V)

Type LKT...-DB for 50 Hz / 60Hz

Article-No.	Type	Capacitance [μ F]	Rated Reactive Power in kvar at Rated Voltage (V_N) 50 Hz / 60 Hz							Rated current at V_N 50 Hz / 60 Hz [A]	Dimensions (d x h) Weight (net) [mm] [kg]	Packing Unit (pcs.)
			230V	300V	400V	415V	440V	480V	525V			
31-10414	LKT 5-400-DB	3 x 33.2	1.66 2.0	2.8 3.33	5.0 6.0					7.2 8.7	60 x 150 0.590	9
31-10400	LKT 6.25-400-DB	3 x 41.4	2.1 2.5	3.5 4.2	6.25 7.5					9.0 10.8	60 x 150 0.590	9
31-10415	LKT 7.5-400-DB	3 x 49.7	2.5 3.0	4.2 5.1	7.5 9.0					10.8 13.0	60 x 150 0.590	9
31-10416	LKT 10-400-DB	3 x 66.3	3.33 4.0	5.6 6.8	10.0 12.0					14.4 17.3	60 x 225 0.840	9
31-10401	LKT 12.5-400-DB	3 x 82.9	4.17 5.0	7.0 8.4	12.5 15.0					18.0 21.7	60 x 225 0.840	9
31-10417	LKT 15-400-DB	3 x 99.5	5.0 6.0	8.4 10.1	15.0 18.0					21.7 26.0	70 x 225 1.090	9
31-10418	LKT 20-400-DB	3 x 132.6	6.66 7.9	11.3 13.5	20.0 24.0					28.9 34.6	85 x 215 1.550	4
31-10402	LKT 25-400-DB	3 x 165.8	8.33 9.9	14.1 16.9	25.0 30.0					36.1 43.3	85 x 278 1.900	4
31-10403	LKT 30-400-DB	3 x 198.9	9.9 11.9	16.9 20.3	30.0 36.0					43.3 52.0	85 x 320 2.200	4
31-10404	LKT 6.25-440-DB	3 x 34.3	1.7 2.0	2.9 3.5	5.2 6.2	5.6 6.7	6.25 7.5			8.2 9.8	60 x 150 0.590	9
31-10412	LKT 10-440-DB	3 x 54.8	2.7 3.33	4.7 5.6	8.33 9.9	8.9 10.7	10.0 12.0			13.1 15.7	60 x 225 0.840	9
31-10379	LKT 12.5-440-DB	3 x 68.5	3.4 4.1	5.8 7.0	10.3 12.4	11.1 13.3	12.5 15.0			16.4 19.7	70 x 225 1.090	9
31-10406	LKT 15-440-DB	3 x 82.2	4.1 4.9	7.0 8.4	12.4 14.9	13.3 16.0	15.0 18.0			19.7 23.6	70 x 225 1.090	9
31-10436	LKT 20-440-DB	3 x 109.6	5.5 6.66	9.3 11.2	16.5 19.8	17.8 21.4	20.0 24.0			26.2 31.5	85 x 215 1.550	4
31-10407	LKT 25-440-DB	3 x 137.0	6.8 8.2	11.6 14.0	20.7 24.8	22.2 26.7	25.0 30.0			32.8 39.4	85 x 278 1.900	4
31-10437	LKT 28.2-440-DB	3 x 154.6	7.7 9.2	13.1 15.7	23.3 27.9	25.0 30.0	28.2 33.8			37.0 44.4	85 x 278 1.900	4
31-10408	LKT 30-440-DB	3 x 165.8	8.3 9.9	14.1 16.9	25.0 30.0	26.9 32.3	30.3 36.3			39.7 47.6	85 x 278 1.900	4
31-10440	LKT 7.2-480-DB	3 x 33.2	1.7 2.0	2.8 3.4	5.0 6.0	5.4 6.5	6.1 7.3	7.2 8.6		8.7 10.4	60 x 225 0.840	9
31-10441	LKT 14.4-480-DB	3 x 66.3	3.3 4.0	5.6 6.8	10.0 12.0	10.8 12.9	12.1 14.5	14.4 17.3		17.3 20.8	70 x 225 1.090	9
31-10442	LKT 18-480-DB	3 x 82.9	4.17 5.0	7.0 8.4	12.5 15.0	13.5 16.2	15.1 18.2	18.0 21.6		21.7 26.0	70 x 265 1.240	9
31-10443	LKT 28.8-480-DB	3 x 132.6	6.6 7.9	11.3 13.5	20.0 24.0	21.5 25.8	24.2 29.0	28.8 34.6		34.6 41.6	85 x 278 1.900	4
31-10438	LKT 33.3-480-DB	3 x 153.4	7.7 9.2	13.0 15.6	23.1 27.8	24.9 29.9	28.0 33.6	33.3 40.0		40.1 48.1	85 x 320 2.200	4
31-10409	LKT 6.25-525-DB	3 x 24.1	1.2 1.4	2.0 2.4	3.6 4.4	3.9 4.7	4.4 5.3	5.2 6.3	6.25 7.5	6.9 8.2	60 x 150 0.590	9
31-10435	LKT 10-525-DB	3 x 38.5	1.9 2.3	3.3 3.9	5.8 7.0	6.3 7.5	7.0 8.4	8.4 10.0	10.0 12.0	11.0 13.2	60 x 225 0.840	9
31-10410	LKT 12.5-525-DB	3 x 48.1	2.4 2.9	4.1 4.9	7.3 8.7	7.8 9.4	8.8 10.5	10.4 12.5	12.5 15.0	13.7 16.5	70 x 225 1.090	9
31-10419	LKT 15-525-DB	3 x 57.7	2.9 3.5	4.9 5.9	8.7 10.5	9.4 11.3	10.5 12.6	12.5 15.1	15.0 18.0	16.5 19.8	70 x 225 1.090	9

Components

Power Capacitors and accessories

Article-No.	Type	Capacitance [µF]	Rated Reactive Power in kvar at Rated Voltage (V _N) 50 Hz / 60 Hz							Rated current at V _N 50 Hz / 60 Hz [A]	Dimensions (d x h) Weight (net) [mm] [kg]	Packing Unit (pcs.)
			230V	300V	400V	415V	440V	480V	525V			
			31-10434	LKT 17.2-525-DB	3 x 66.2	3.3 4.0	5.6 6.7	10.0 12.0	10.8 12.9			
31-10420	LKT 20-525-DB	3 x 77.0	3.8 4.6	6.5 7.8	11.6 13.9	12.5 15.0	14.1 16.9	16.7 20.1	20.0 24.0	22.0 26.4	70 x 265 1.240	9
31-10411	LKT 25-525-DB	3 x 96.2	4.8 5.8	8.2 9.8	14.5 17.4	15.6 18.8	17.6 21.1	20.9 25.1	25.0 30.0	27.5 33.0	85 x 278 1.900	4
31-10439	LKT 30-525-DB	3 x 115.5	5.8 6.9	9.8 11.8	17.4 20.9	18.8 22.5	21.1 25.3	25.1 30.1	30.0 36.0	33.0 39.6	85 x 278 1.900	4

Standard Capacitors (three-phase, V_N: 300 V...480 V)

Type LKT...-DP for 50 Hz / 60 Hz

Article-No.	Type	Capacitance [µF]	Rated Reactive Power in kvar at Rated Voltage (V _N) 50 Hz / 60 Hz							Rated current at V _N 50 Hz / 60 Hz [A]	Dimensions (d x h) Weight (net) [mm] [kg]	Packing Unit (pcs.)
			230V	300V	400V	415V	440V	460V	480V			
			31-10523	LKT 7.1-300-DP	3 x 83.7	4.17 5.0	7.1 8.5					
31-10553	LKT 14.2-300-DP	3 x 167.1	8.33 10.0	14.2 17.0						27.3 32.7	85 x 215 1.550	4
31-10525	LKT 21.3-300-DP	3 x 251.1	12.5 15.0	21.3 25.5						41.0 49.2	85 x 278 1.900	4
31-10500	LKT 5-400-DP	3 x 33.2	1.66 2.0	2.8 3.33	5.0 6.0					7.2 8.7	60 x 150 0.590	9
31-10380	LKT 10-400-DP	3 x 66.3	3.33 4.0	5.6 6.8	10.0 12.0					14.4 17.3	70 x 225 1.090	9
31-10502	LKT 12.5-400-DP	3 x 82.9	4.17 5.0	7.0 8.4	12.5 15.0					18.0 21.7	70 x 225 1.090	9
31-10503	LKT 15-400-DP	3 x 99.5	5.0 6.0	8.4 10.1	15.0 18.0					21.7 26.0	70 x 265 1.240	9
31-10504	LKT 20-400-DP	3 x 132.6	6.66 8.0	11.3 13.5	20.0 24.0					28.9 34.6	85 x 278 1.900	4
31-10505	LKT 25-400-DP	3 x 165.8	8.33 9.9	14.1 16.9	25.0 30.0					36.1 43.3	85 x 278 1.900	4
31-10534	LKT 3.8-440-DP	3 x 20.8	1.0 1.25	1.8 2.1	3.1 3.8	3.4 4.1	3.8 4.6			5.0 6.0	60 x 150 0.590	9
31-10508	LKT 10-440-DP	3 x 54.8	2.7 3.33	4.7 5.6	8.33 9.9	8.9 10.7	10.0 12.0			13.1 15.7	60 x 225 0.840	9
31-10507	LKT 12.5-440-DP	3 x 68.5	3.4 4.1	5.8 7.0	10.3 12.4	11.1 13.3	12.5 15.0			16.4 19.1	70 x 225 1.090	9
31-10381	LKT 15-440-DP	3 x 82.2	4.1 4.9	7.0 8.33	12.4 14.9	13.3 16.0	15.0 18.0			19.7 23.6	70 x 265 1.240	9
31-10512	LKT 20-440-DP	3 x 109.6	5.5 6.66	9.3 11.2	16.5 19.8	17.8 21.4	20.0 24.0			26.2 31.5	85 x 278 1.900	4
31-10510	LKT 25-440-DP	3 x 137.0	6.8 8.2	11.6 14.0	20.7 24.8	22.2 26.7	25.0 30.0			32.8 39.4	85 x 278 1.900	4
31-10535	LKT 28.2-440-DP	3 x 154.6	7.7 9.2	13.1 15.7	23.3 27.9	25.0 30.0	28.2 33.8			37.0 44.4	85 x 320 2.200	4
31-10509	LKT 30-440-DP	3 x 165.8	8.3 9.9	14.1 16.9	25.0 30.0	26.9 32.3	30.3 36.3			39.7 47.6	85 x 320 2.200	4
31-10390	LKT 12.5-480-DP	3 x 57.6	2.9 3.4	4.9 5.9	8.7 10.4	9.3 11.2	10.5 12.6	11.5 13.8	12.5 15.0	15.0 18.0	70 x 225 1.090	9

Components

Power Capacitors and accessories

1

Article-No.	Type	Capacitance [μ F]	Rated Reactive Power in kvar at Rated Voltage (V_N) 50 Hz / 60 Hz							Rated current at V_N 50 Hz / 60 Hz [A]	Dimensions (d x h) Weight (net) [mm] [kg]	Packing Unit (pcs.)
			230V	300V	400V	415V	440V	460V	480V			
			31-10382	LKT 15.5-480-DP	3 x 71.4	3.6 4.3	6.1 7.3	10.8 13.0	11.6 13.9			
31-10522	LKT 18-480-DP	3 x 82.9	4.17 5.0	7.0 8.4	12.5 15.0	13.5 16.2	15.1 18.2	16.5 19.8	18.0 21.6	21.7 26.0	70 x 265 1.240	9
31-10559	LKT 31-480-DP	3 x 142.8	7.1 8.5	12.1 14.5	21.5 25.8	23.2 27.8	26.1 31.3	28.5 34.2	31.0 37.2	37.3 44.7	85 x 320 2.200	4
31-10558	LKT 33.3-480-DP	3 x 153.4	7.7 9.2	13.0 15.6	23.1 27.8	24.9 29.9	28.0 33.6	30.6 36.7	33.3 40.0	40.1 48.1	85 x 320 2.200	4

Standard Capacitors (three-phase, $V_N = 525$ V)

Type LKT...-DP for 50 Hz / 60 Hz

Article-No.	Type	Capacitance [μ F]	Rated Reactive Power in kvar at Rated Voltage (V_N) 50 Hz / 60 Hz							Rated current at V_N 50 Hz / 60 Hz [A]	Dimensions (d x h) Weight (net) [mm] [kg]	Packing Unit (pcs.)
			230V	300V	400V	415V	440V	480V	525V			
			31-10517	LKT 10-525-DP	3 x 38.5	1.9 2.3	3.3 3.9	5.8 7.0	6.3 7.5			
31-10516	LKT 12.5-525-DP	3 x 48.1	2.4 2.9	4.1 4.9	7.3 8.7	7.8 9.4	8.8 10.5	10.4 12.5	12.5 15.0	13.7 16.5	70 x 225 1.090	9
31-10520	LKT 15-525-DP	3 x 57.7	2.9 3.5	4.9 5.9	8.7 10.4	9.4 11.3	10.5 12.6	12.5 15.0	15.0 18.0	16.5 19.8	70 x 265 1.240	9
31-10521	LKT 20-525-DP	3 x 77.0	3.8 4.6	6.5 7.8	11.6 13.9	12.5 15.0	14.1 16.9	16.7 20.1	20.0 24.0	22.0 26.4	85 x 278 1.900	4
31-10446	LKT 21.6-525-DP	3 x 83.2	4.1 4.9	7.0 8.4	12.5 15.0	13.5 16.2	15.2 18.2	18.1 21.7	21.6 25.9	23.8 28.6	85 x 278 1.900	4
31-10519	LKT 25-525-DP	3 x 96.2	4.8 5.8	8.2 9.8	14.5 17.4	15.6 18.8	17.6 21.1	20.9 25.1	25.0 30.0	27.5 33.0	85 x 278 1.900	4
31-10444	LKT 28.7-525-DP	3 x 110.5	5.5 6.6	9.4 11.3	16.7 20.0	18.0 21.6	20.2 24.2	24.0 28.8	28.7 34.4	31.6 37.9	85 x 320 2.200	4

Standard Capacitors (three-phase, V_N : 690 V...800 V)

Type LKT...-DP for 50 Hz / 60 Hz

Article-No.	Type	Capacitance [μ F]	Rated Reactive Power in kvar at Rated Voltage (V_N) 50 Hz / 60 Hz							Rated current at V_N 50 Hz / 60 Hz [A]	Dimensions (d x h) Weight (net) [mm] [kg]	Packing Unit (pcs.)
			525V	570V	600V	615V	690V	760V	800V			
			31-10560	LKT 5-690-DP	3 x 11.1	2.9 3.5	3.4 4.1	3.8 4.5	4.0 4.8			
31-10561	LKT 10-690-DP	3 x 22.3	5.8 7.0	6.8 8.2	7.6 9.1	7.9 9.5	10.0 12.0			8.4 10.0	70 x 225 1.090	9
31-10562	LKT 12.5-690-DP	3 x 27.9	7.2 8.7	8.5 10.2	9.5 11.3	9.9 11.9	12.5 15.0			10.5 12.6	70 x 265 1.240	9
31-10563	LKT 15-690-DP	3 x 33.4	8.7 10.4	10.2 12.3	11.3 13.6	11.9 14.3	15.0 18.0			12.6 15.1	70 x 265 1.240	9
31-10564	LKT 20-690-DP	3 x 44.6	11.6 13.9	13.7 16.4	15.1 18.2	15.9 19.1	20.0 24.0			16.7 20.1	85 x 278 1.900	4

Components

Power Capacitors and accessories

Article-No.	Type	Capacitance [μF]	Rated Reactive Power in kvar at Rated Voltage (V _N) 50 Hz / 60 Hz								Rated current at V _N 50 Hz / 60 Hz [A]	Dimensions (d x h) Weight (net) [mm] [kg]	Packing Unit (pcs.)
			525 V	570 V	600 V	615 V	690 V	760 V	800 V				
31-10565	LKT 25-690-DP	3 x 55.7	14.5 17.4	17.1 20.5	18.9 22.7	19.9 23.8	25.0 30.0			20.9 25.1	85 x 278 1.900	4	
31-10569	LKT 28.2-760-DP	3 x 51.8	13.5 16.1	15.9 19.0	17.6 21.1	18.5 22.2	23.2 27.9	28.2 33.8		21.4 25.7	85 x 320 2.200	4	
31-10570	LKT 6.7-800-DP	3 x 11.1	2.9 3.5	3.4 4.1	3.8 4.5	4.0 4.8	5.0 6.0	6.0 7.3	6.7 8.0	4.8 5.8	60 x 225 0.840	9	
31-10571	LKT 10.5-800-DP	3 x 17.4	4.5 5.4	5.3 6.4	5.9 7.1	6.2 7.5	7.8 9.4	9.5 11.4	10.5 12.6	7.6 9.1	70 x 225 1.090	9	
31-10572	LKT 13.3-800-DP	3 x 22.0	5.7 6.9	6.8 8.1	7.5 9.0	7.9 9.4	9.9 11.9	12.0 14.4	13.3 16.0	9.6 11.5	85 x 215 1.550	4	
31-10573	LKT 21-800-DP	3 x 34.8	9.0 10.9	10.7 12.8	11.8 14.2	12.4 14.9	15.6 18.8	19.0 22.7	21.0 25.2	15.2 18.2	85 x 278 1.900	4	
31-10574	LKT 26.7-800-DP	3 x 44.3	11.5 13.8	13.6 16.3	15.0 18.0	15.8 18.9	19.9 23.8	24.1 28.9	26.7 32.0	19.3 23.1	85 x 320 2.200	4	

Standard Capacitors (single-phase, V_N: 280 V...525 V)

Type LKT...-EP for 50 Hz / 60 Hz

Article-No.	Type	Capacitance [μF]	Rated Reactive Power in kvar at Rated Voltage (V _N) 50 Hz / 60 Hz								Rated current at V _N 50 Hz / 60 Hz [A]	Dimensions (d x h) Weight (net) [mm] [kg]	Packing Unit (pcs.)
			230 V	280 V	400 V	415 V	440 V	480 V	525 V				
31-10547	LKT 5-280-EP	1 x 203.7	3.4 4.1	5.0 6.0						17.9 21.5	60 x 138 0.530	9	
31-10548	LKT 10-280-EP	1 x 407.4	6.8 8.1	10.0 12.0						35.8 43.0	85 x 131 1.200	4	
31-10526	LKT 3.33-440-EP	1 x 54.8	0.9 1.1	1.4 1.6	2.8 3.3	3.0 3.6	3.33 4.0			7.6 9.1	60 x 90 0.355	9	
31-10527	LKT 4.17-440-EP	1 x 68.6	1.1 1.4	1.7 2.0	3.4 4.1	3.7 4.5	4.17 5.0			9.5 11.4	60 x 138 0.530	9	
31-10528	LKT 5-440-EP	1 x 82.2	1.4 1.6	2.0 2.4	4.1 5.0	4.4 5.33	5.0 6.0			11.4 13.6	60 x 138 0.530	9	
31-10384	LKT 9.4-440-EP	1 x 154.6	2.6 3.1	3.6 4.3	7.8 9.3	8.4 10.0	9.4 11.3			21.4 25.6	70 x 153 0.680	9	
31-10529	LKT 2.4-480-EP	1 x 33.2	0.6 0.7	0.8 1.0	1.7 2.0	1.8 2.15	2.0 2.4	2.4 2.9		5.0 6.0	60 x 90 0.355	9	
31-10530	LKT 3.33-480-EP	1 x 46.0	0.8 0.9	1.1 1.4	2.3 2.8	2.5 3.0	2.8 3.4	3.33 4.0		6.9 8.3	60 x 90 0.355	9	
31-10531	LKT 3.6-480-EP	1 x 49.7	0.8 1.0	1.2 1.5	2.5 3.0	2.7 3.2	3.0 3.6	3.6 4.3		7.5 9.0	60 x 138 0.530	9	
31-10515	LKT 4.8-480-EP	1 x 66.3	1.1 1.3	1.6 2.0	3.33 4.0	3.6 4.3	4.0 4.8	4.8 5.8		10.0 12.0	60 x 138 0.530	9	
31-10514	LKT 6-480-EP	1 x 82.9	1.4 1.7	2.0 2.5	4.17 5.0	4.5 5.4	5.0 6.0	6.0 7.2		12.5 15.0	60 x 138 0.530	9	
31-10532	LKT 2.8-525-EP	1 x 32.3	0.5 0.6	0.8 1.0	1.6 1.9	1.7 2.1	2.0 2.4	2.3 2.8	2.8 3.4	5.3 6.4	60 x 90 0.355	9	
31-10533	LKT 3.33-525-EP	1 x 38.5	0.6 0.8	1.0 1.1	1.9 2.3	2.1 2.5	2.3 2.8	2.8 3.3	3.33 4.0	6.3 7.6	60 x 138 0.530	9	
31-10385	LKT 8.33-525-EP	1 x 96.2	1.6 1.9	2.4 2.9	4.8 5.8	5.2 6.3	5.9 7.0	7.0 8.33	8.33 10.0	15.9 19.0	70 x 153 0.680	9	

Components

Power Capacitors and accessories

Premium Capacitors (three-phase, V_N : 400 V...480 V)

Type LKT...-DL for 50 Hz / 60 Hz

Article-No.	Type	Capacitance [μ F]	Rated Reactive Power in kvar at Rated Voltage (V_N) 50 Hz / 60 Hz							Rated current at V_N 50 Hz / 60 Hz [A]	Dimensions (d x h) Weight (net) [mm] [kg]	Packing Unit (pcs.)
			230V	400V	415V	440V	460V	480V	525V			
31-10598	LKT 1-400-DL	3 x 6.6	0.3 0.4	1.0 1.2	1.1 1.3	1.2 1.5				1.4 1.7	60 x 150 0.550	9
31-10599	LKT 1.5-400-DL	3 x 9.9	0.5 0.6	1.5 1.8	1.6 1.9	1.8 2.2				2.2 2.6	60 x 150 0.590	9
31-10600	LKT 5-400-DL	3 x 33.2	1.66 2.0	5.0 6.0	5.4 6.5	6.1 7.3				7.2 8.7	60 x 225 0.840	9
31-10601	LKT 6.25-400-DL	3 x 41.4	2.1 2.5	6.25 7.5	6.7 8.1	7.6 9.1				9.0 10.8	60 x 225 0.840	9
31-10602	LKT 9.3-400-DL	3 x 61.7	3.0 3.7	9.3 11.1	10.0 12.0	11.3 13.5				13.4 16.1	70 x 225 1.090	9
31-10603	LKT 10-400-DL	3 x 66.3	3.33 4.0	10.0 12.0	10.8 12.9	12.1 14.5				14.4 17.3	70 x 225 1.090	9
31-10604	LKT 11.7-400-DL	3 x 77.6	3.9 4.6	11.7 14.0	12.6 15.1	14.2 17.0				16.9 20.3	70 x 225 1.090	9
31-10386	LKT 12.5-400-DL	3 x 82.9	4.17 5.0	12.5 15.0	13.5 16.2	15.1 18.2				18.0 21.7	70 x 265 1.240	9
31-10606	LKT 20-400-DL	3 x 132.6	6.6 7.9	20.0 24.0	21.5 25.8	24.2 29.0				28.9 34.6	85 x 278 1.900	4
31-10607	LKT 5.0-440-DL	3 x 27.4	1.4 1.66	4.17 5.0	4.5 5.4	5.0 6.0	5.5 6.6	6.0 7.1		6.6 7.9	60 x 225 0.840	9
31-10608	LKT 7.6-440-DL	3 x 41.7	2.1 2.5	6.25 7.5	6.8 8.1	7.6 9.1	8.33 10.0	9.0 10.9		10.0 12.0	60 x 225 0.840	9
31-10387	LKT 9.1-440-DL	3 x 49.9	2.5 3.0	7.5 9.0	8.1 9.7	9.1 10.9	10.0 11.9	10.8 13.0		11.9 14.3	70 x 225 1.090	9
31-10610	LKT 12.1-440-DL	3 x 66.3	3.33 4.0	10.0 12.0	10.8 12.9	12.1 14.5	13.2 15.9	14.4 17.3		15.9 19.1	70 x 225 1.090	9
31-10612	LKT 17.6-440-DL	3 x 96.5	4.8 5.8	14.5 17.4	15.6 18.8	17.6 21.1	19.2 23.1	21.0 25.1		23.1 27.7	85 x 278 1.900	4
31-10613	LKT 3.6-480-DL	3 x 16.6	0.8 1.0	2.5 3.0	2.7 3.2	3.0 3.6	3.33 4.0	3.6 4.3	4.3 5.2	4.3 5.2	60 x 150 0.590	9
31-10388	LKT 4.5-480-DL	3 x 20.7	1.0 1.2	3.1 3.8	3.4 4.0	3.8 4.6	4.1 5.0	4.5 5.4	5.4 6.5	5.4 6.5	60 x 225 0.840	9
31-10615	LKT 7.2-480-DL	3 x 33.2	1.7 2.0	5.0 6.0	5.4 6.5	6.0 7.2	6.66 7.9	7.2 8.6	8.6 10.3	8.7 10.4	60 x 225 0.840	9
31-10616	LKT 7.8-480-DL	3 x 35.9	1.8 2.1	5.4 6.5	5.8 7.0	6.5 7.9	7.2 8.6	7.8 9.3	9.3 11.2	9.4 11.3	60 x 225 0.840	9
31-10617	LKT 10.4-480-DL	3 x 47.9	2.4 2.9	7.3 8.7	7.8 9.3	8.8 10.5	9.6 11.5	10.4 12.5	12.4 14.9	12.5 15.0	70 x 225 1.090	9
31-10618	LKT 12.5-480-DL	3 x 57.6	2.9 3.4	8.7 10.4	9.4 11.2	10.5 12.6	11.5 13.8	12.5 15.0	15.0 17.9	15.0 18.0	70 x 265 1.240	9
31-10389	LKT 15.5-480-DL	3 x 71.4	3.6 4.3	10.8 12.9	11.6 13.9	13.0 15.6	14.2 17.1	15.5 18.6	18.5 22.3	18.6 22.4	85 x 278 1.900	4

Areas shaded dark grey indicate power (kvar) at higher voltages according to capacitor type "DP" (see specification page 13).

Components

Power Capacitors and accessories

1

Premium Capacitors (three-phase, $V_N = 525\text{ V}$)

Typ LKT...-DL for 50 Hz / 60 Hz

Article-No.	Type	Capacitance [μF]	Rated Reactive Power in kvar at Rated Voltage (V_N) 50 Hz / 60 Hz								Rated current at V_N 50 Hz / 60 Hz [A]	Dimensions (d x h) Weight (net) [mm] [kg]	Packing Unit (pcs.)
			400V	415V	440V	480V	525V	570V	615V				
31-10619	LKT 4.17-525-DL	3x 16.1	2.4 2.9	2.6 3.1	2.9 3.5	3.5 4.2	4.17 5.0	4.9 5.9	5.7 6.9	4.6 5.5	60 x 225 0.840	9	
31-10620	LKT 5.9-525-DL	3x 22.7	3.4 4.1	3.7 4.4	4.17 4.97	5.0 5.9	5.9 7.1	7.0 8.4	8.1 9.7	6.5 7.8	60 x 225 0.840	9	
31-10621	LKT 7.7-525-DL	3x 29.6	4.5 5.4	4.8 5.8	5.4 6.5	6.5 7.8	7.7 9.3	9.1 10.9	10.6 12.7	8.5 10.2	70 x 225 1.090	9	
31-10622	LKT 8.33-525-DL	3x 32.1	4.8 5.8	5.2 6.2	5.8 7.0	7.0 8.33	8.33 10.0	9.8 11.8	11.4 13.7	9.2 11.0	70 x 225 1.090	9	

Generally, "Premium" (DL-type) capacitors can also be operated at higher voltages with the "Standard" (DP-type) specification. Please note that the DP values in the chart are shaded dark grey.

Heavy Duty Capacitors (three-phase, $V_N: 480\text{ V}..525\text{ V}$)

Typ LKT...-HD for 50 Hz / 60 Hz

Article-No.	Type	Capacitance [μF]	Rated Reactive Power in kvar at Rated Voltage (V_N) 50 Hz / 60 Hz								Rated current at V_N 50 Hz / 60 Hz [A]	Dimensions (d x h) Weight (net) [mm] [kg]	Packing Unit (pcs.)
			400V	415V	440V	460V	480V	500V	525V				
31-10580	LKT 16.8-480-HD	3 x 77.4	11.7 14.0	12.6 15.1	14.1 16.9	15.4 18.5	16.8 20.2			20.2 24.2	85 x 215 1.550	4	
31-10581	LKT 18.0-480-HD	3 x 82.9	12.5 15.0	13.5 16.2	15.1 18.2	16.5 19.8	18.0 21.6			21.7 26.0	85 x 215 1.550	4	
31-10582	LKT 15.6-500-HD	3 x 66.2	10.0 12.0	10.8 12.9	12.1 14.5	13.2 15.8	14.4 17.3	15.6 18.7		18.0 21.6	85 x 215 1.550	4	
31-10583	LKT 16.1-500-HD	3 x 68.3	10.3 12.4	11.1 13.3	12.5 15.0	13.6 16.4	14.8 17.8	16.1 19.3		18.6 22.3	85 x 215 1.550	4	
31-10584	LKT 16.8-500-HD	3 x 71.3	10.8 12.9	11.6 13.9	13.0 15.6	14.2 17.1	15.5 18.6	16.8 20.2		19.4 23.3	85 x 215 1.550	4	
31-10585	LKT 18.0-525-HD	3 x 69.3	10.5 12.5	11.3 13.5	12.6 15.2	13.8 16.6	15.1 18.1	16.3 19.6	18.0 21.6	19.8 23.8	85 x 215 1.550	4	

Components

Power Capacitors and accessories

1

Dimensions

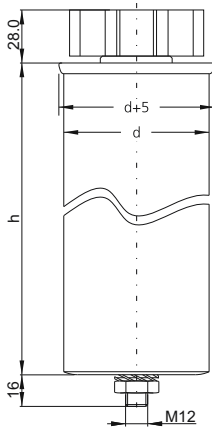

Three-phase capacitor with $d = 60/70$ mm
Spring tension terminal AKD 25/3 for 2×6 mm²

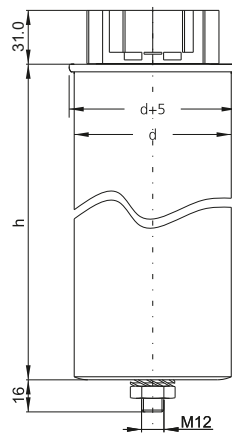

Three-phase capacitor with $d = 85$ mm
Spring tension terminal AKD 30/3 for 16 mm²

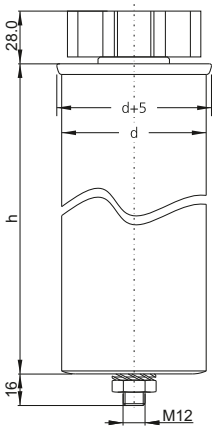
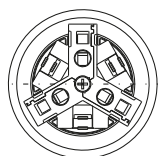
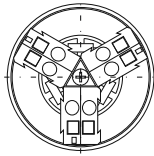

Single-phase capacitor with $d = 60/70$ mm
Spring tension terminal AKD 25/2 for 2×6 mm²

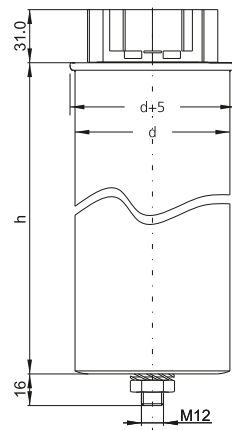

Single-phase capacitor with $d = 85$ mm
Spring tension terminal AKD 30/2 for 16 mm²

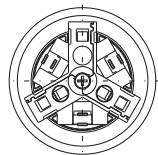

Components

Basic and Standard Harmonic Filter Reactors



1

Harmonic Filter Reactors

Basic and Standard Harmonic Filter Reactors

Avoiding resonances – low-loss Harmonic Filter Reactors for your power factor correction – designed for operation with FRAKO Power Capacitors.

- Power range: 3.13 to 200 kvar
- Voltage range: 230 V to 690 V, 50 / 60 Hz
- Detuning factor $p = 5.67\% - 14\%$
- Low-loss design

Application Recommendations

Used together with LKT type Power Factor Correction Capacitors, Harmonic Filter Reactors make it possible to install detuned versions of fixed capacitor banks and Power Factor Correction Systems. This enables switchgear manufacturers to plan and manufacture customer-specific systems.

Components

Basic and Standard Harmonic Filter Reactors

Type Overview

Type series		Basic	Standard
Type		FDKT	FDR / FKD
Rated voltage		400...525 V	230...690 V
Rated stage power		6.25...200 kvar	3.13...50 kvar
Rated frequency		50 / 60 Hz	• / •
Series resonance frequency	p=5.67 %	210 / 252 Hz	- / -
	p=7 %	189 / 227 Hz	• / •
	p=8 %	177 / 212 Hz	• / -
	p=14 %	134 / 160 Hz	• / -
Temperature range		-10 ... +60 °C	
Winding material		Al	Al / Cu
Insulation class		H (180 °C)	F (155 °C)
Temperature switch	pre-assembled	•	•
	Switching temperature	130...150 °C	140 °C
	Switching capacity	6.3A / 250 V AC	2.5A / 250 V AC
Ingress protection		IP00 according to IEC 60529	
Power loss max.		10 W/kvar	6 W/kvar
Connection		Terminal strip ≤ 25 kvar Ring terminal ≥ 50 kvar	Connecting cable
Catalogue page		Page 23 ff.	Page 27 ff.

Series Resonance Frequency

Version	Series resonance frequency (50 Hz Mains)	Detuning factor	For mains with utility audio frequency ¹⁾
P1	134 Hz	P= 14 %	≥ 166 Hz
P8	177 Hz	P= 8 %	≥ 217 Hz
P7	189 Hz	P= 7 %	≥ 228 Hz
P5	210 Hz	P= 5.67 %	≥ 270 Hz

¹⁾ Utility company specifications inconsistent with the above must be taken into account.

Please also refer to the design notes given in our manual of Power Factor Correction. Further series resonance frequencies are available on request.

Connection

Coil input: U1, V1, W1

Coil output: U2, V2, W2

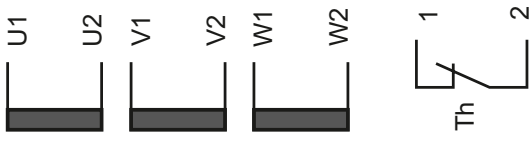

Important Note

Please only use the correct number of the appropriate Power Capacitors as specified in our "Selection Aid: Harmonic Filter Reactors → Capacitors" in our Technical Annex. Apart from possibly overloading the installed components, the utility company's remote control systems could also be adversely affected.

Components

Basic Harmonic Filter Reactors



1

FDKT Basic Harmonic Filter Reactors

Avoiding resonances – low-loss Harmonic Filter Reactors for your power factor correction – designed for operation with FRAKO Power Capacitors.

- Power Range: 6.25 to 200 kvar
- Voltage range: 400 to 525 V, 50 Hz
- Detuning factor $p = 7\% - 14\%$
- Low-loss design

Application Recommendations

Used together with LKT type Power Factor Correction Capacitors, Harmonic Filter Reactors make it possible to install detuned versions of fixed capacitor banks and Power Factor Correction Systems. This enables switchgear manufacturers to plan and manufacture customer-specific systems.

Components

Basic Harmonic Filter Reactors

Technical Data

Version: P7 (Detuning factor $p = 7\%$)

$I_{5_{max}} = 33.8\%$, $I_{7_{max}} = 12.2\%$, Linearity = $1.75 \times I_N$

Article- No.	Type	Q [kvar]	I_N [A]	L [mH]	C [μF]	Size	Connection		Weight approx. [kg]	Winding material	Al/Cu Weight [kg]
							Cable [mm ²]	Terminal [mm ²]			

Basic Harmonic Filter Reactor - FDKT - $V_N = 400\text{ V} / 50\text{ Hz} - p = 7\%$ - fres = 189 Hz

88-02103	FDKT 6,25-400-P7	6.3	9.9	6.139	3 x 38.5	a		10	5.5	Al	0.6
88-02045	FDKT 12,5-400-P7	12.5	19.8	3.067	3 x 77.6	b		10	8.0	Al	1.1
88-02046	FDKT 25-400-P7	25.0	39.7	1.533	3 x 155.2	d		10	17.0	Al	1.6
88-02047	FDKT 50-400-P7	50.0	79.4	0.767	3 x 310.4	i	M8		29.0	Al	2.2
88-02093	FDKT 75-400-P7	75.0	119.1	0.511	3 x 465.6	n	M8		40.0	Al	3.1
88-02094	FDKT 100-400-P7	100.0	158.9	0.384	3 x 620.8	q	M8		47.0	Al	5.1

Basic Harmonic Filter Reactor - FDKT - $V_N = 415\text{ V} / 50\text{ Hz} - p = 7\%$ - fres = 189 Hz

88-02098	FDKT 12,5-415-P7	12.5	19.1	3.304	3 x 71.4	b	M6	10	8.0	Al	0.9
88-02099	FDKT 25-415-P7	25.0	38.3	1.652	3 x 142.8	d	M6		17.0	Al	1.3
88-02100	FDKT 50-415-P7	50.0	76.6	0.826	3 x 285.6	i	M8		29.0	Al	3.0
88-02101	FDKT 75-415-P7	75.0	114.8	0.521	3 x 428.4	n	M8		39.0	on request	on request
88-02190	FDKT 100-415-P7	100.0	153.2	0.413	3 x 572.3	r	M8		48.0	Al	5.4

Basic Harmonic Filter Reactor - FDKT - $V_N = 525\text{ V} / 50\text{ Hz} - p = 7\%$ - fres = 189 Hz

88-02146	FDKT 12,5-525-P7	12.5	15.1	5.228	3 x 44.7	b	M8		9.0	on request	on request
88-02147	FDKT 25-525-P7	25.0	30.3	2.644	3 x 89.4	f	M8		16.0	on request	on request
88-02148	FDKT 50-525-P7	50.0	60.5	1.322	3 x 178.8	h	M10		30.0	on request	on request
88-02149	FDKT 75-525-P7	75.0	90.8	0.881	3 x 268.2	k	M10		43.0	on request	on request
88-02150	FDKT 100-525-P7	100.0	121.0	0.661	3 x 357.6	l	M10		51.0	on request	on request
88-02151	FDKT 150-525-P7	150.0	181.6	0.441	3 x 536.4	s	M10		87.0	on request	on request
88-02152	FDKT 200-525-P7	200.0	242.1	0.330	3 x 715.2	t	M10		102.0	on request	on request

Version: P1 (Detuning factor $p = 14\%$)

$I_{5_{max}} = 9,6\%$, $I_{7_{max}} = 4,7\%$, Linearity = $1,75 \times I_N$

Article- No.	Type	Q [kvar]	I_N [A]	L [mH]	C [μF]	Size	Connection		Weight approx. [kg]	Winding material	Al/Cu Weight [kg]
							Cable [mm ²]	Terminal [mm ²]			

Basic Harmonic Filter Reactor - FDKT - $V_N = 400\text{ V} / 50\text{ Hz} - p = 14\%$ - fres = 134 Hz

88-02095	FDKT 12,5-400-P1	12.5	19.9	6.598	3 x 71.4	e	M8		16.0	Al	1.1
88-02096	FDKT 25-400-P1	25.0	39.7	3.299	3 x 142.8	g	M8		27.0	Al	2.4
88-02097	FDKT 50-400-P1	50.0	79.4	1.649	3 x 285.6	m	M10		42.0	Al	5.3

Basic Harmonic Filter Reactor - FDKT - $V_N = 525\text{ V} / 50\text{ Hz} - p = 14\%$ - fres = 134 Hz

88-02153	FDKT 12,5-525-P1	12.5	15.1	11.445	3 x 41.1	c	M8		15.0	on request	on request
88-02154	FDKT 25-525-P1	25.0	30.3	5.723	3 x 82.2	j	M8		26.0	on request	on request
88-02155	FDKT 50-525-P1	50.0	60.5	2.861	3 x 164.4	o	M10		44.0	on request	on request
88-02156	FDKT 75-525-P1	75.0	90.8	1.908	3 x 246.6	p	M10		56.0	on request	on request
88-02157	FDKT 100-525-P1	100.0	121.0	1.431	3 x 328.8	u	M10		98.0	on request	on request
88-02158	FDKT 150-525-P1	150.0	181.6	0.954	3 x 439.2	v	M10		125.0	on request	on request
88-02159	FDKT 200-525-P1	200.0	242.1	0.715	3 x 657.6	w	M10		144.0	on request	on request

Components

Basic Harmonic Filter Reactors

Important Note

All Harmonic Filter Reactors, type FDKT are also available without temperature switch.
Harmonic Filter Reactors without temperature switch are marked type „FDK“.

Dimensions

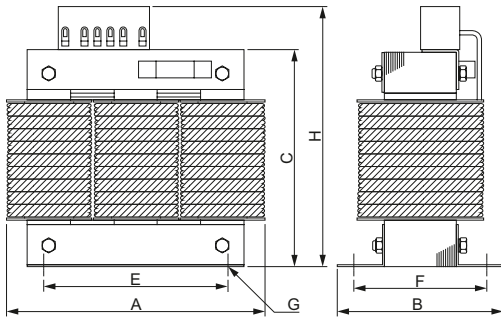

6.25 - 25 kvar

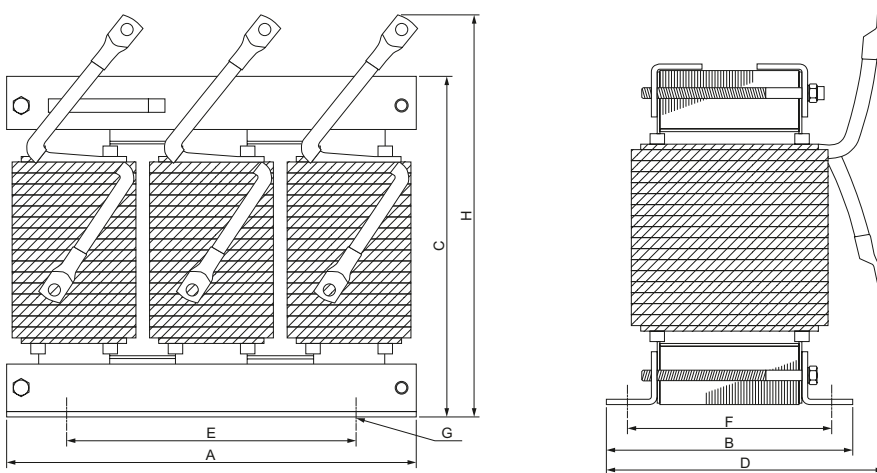

50 - 200 kvar

Components

Basic Harmonic Filter Reactors

1

Core 3UI	Dimensions [mm]							
	A	B	C	D	E	F	G	H
a	150	93	130		106	77	6 x 15	155
b	180	112	155		120	90	10 x 13	190
c	225	125	171		175	103	11 x 13	202
d	225	124	177	150	175	101	10 x 13	220
e	225	125	160		175	103	11 x 20	192
f	225	125	190		175	103	11 x 20	220
g	250	148	215		200	114	11 x 20	266
h	283	145	260	188	200	116	11 x 20	300
i	283	148	215	188	200	110	11 x 20	255
j	283	148	238	170	200	117	11 x 20	268
k	283	166	300	188	224	126	11 x 20	360
l	283	166	362	188	224	126	11 x 20	362
m	283	170	260	210	200	141	11 x 20	310
n	309	166	268	200	224	126	11 x 20	315
o	309	166	310	188	224	126	11 x 20	360
p	309	166	402	188	224	126	11 x 20	380
q	315	166	302	210	224	126	11 x 20	360
r	315	166	322	210	224	126	11 x 20	370
s	390	200	380	240	310	130	11 x 20	390
t	414	220	400	259	334	130	11 x 20	414
u	470	220	380	250	410	126	11 x 20	402
v	470	220	400	300	410	126	11 x 20	400
w	520	270	420	320	440	126	11 x 20	420

Components

Standard Harmonic Filter Reactors



FDR / FKD Standard Harmonic Filter Reactors

Avoiding resonances – low-loss Harmonic Filter Reactors for your power factor correction – designed for operation with FRAKO Power Capacitors.

- Power range: 3.13 to 50 kvar
- Voltage range: 230 to 690 V, 50 / 60 Hz
- Detuning factor $p = 5.67 \% - 14 \%$
- Low-loss design

Application Recommendations

Used together with LKT type Power Factor Correction Capacitors, Harmonic Filter Reactors make it possible to install detuned versions of fixed capacitor banks and Power Factor Correction Systems. This enables switchgear manufacturers to plan and manufacture customer-specific systems.

Components

Standard Harmonic Filter Reactors

Technical Data

Version: P7 (Detuning factor $p = 7\%$), 50 Hz

Permissible harmonics EN 61000-2-4 Class 2

Article-No.	Type	Q [kvar]	I_N [A]	L [mH]	C [μF]	Size	Connection		Weight approx. [kg]	Winding material	Al/Cu Weight [kg]
							Cable [mm ²]	Terminal [mm ²]			

Standard Harmonic Filter Reactor - FDR/FKD - $V_N = 230\text{ V} / 50\text{ Hz} - p = 7\% - f_{res} = 189\text{ Hz}$

88-01980	FDR 5-230-P7	5.0	12.6	2.530	3 x 93.3	c	6		5.0	Cu	1.7
88-01575	FKD 10-230-P7	10.0	26.9	1.180	3 x 200.0	e	10		9.0	Cu	2.0
88-01974	FDR 12,5-230-P7	12.5	31.2	1.020	3 x 232.1	f	10		9.0	Cu	2.3
88-01583	FKD 16,7-230-P7	16.7	44.9	0.700	3 x 334.0	g	10/2x4		10.0	Cu	2.5
88-01576	FKD 20-230-P7	20.0	53.8	0.590	3 x 400.0	h	16/2x10		15.0	Cu	2.4
88-01943	FDR 25-230-P7	25.0	62.5	0.510	3 x 464.2	h	16		16.0	Cu	4.9
88-01568	FKD 33-230-P7	33.0	89.9	0.354	3 x 668.0	m	2x16/2x16		19.0	Al	3.9

Standard Harmonic Filter Reactor - FDR/FKD - $V_N = 400\text{ V} / 50\text{ Hz} - p = 7\% - f_{res} = 189\text{ Hz}$

88-01640	FKD 2,5-400-P7	2.5	3.9	14.200	3 x 16.6	a	4		5.0	Cu	0.4
88-01719	FKD 3,13-400-P7	3.1	4.7	11.900	3 x 19.9	c	4		7.0	Cu	1.0
88-01481	FKD 5-400-P7	5.0	7.8	7.120	3 x 33.2	c	4		7.0	Cu	1.1
88-01410	FKD 6,25-400-P7	6.3	9.7	5.700	3 x 41.5	c	4		7.0	Cu	1.7
88-01482	FKD 7,5-400-P7	7.5	11.6	4.760	3 x 49.7	c	4		7.0	Cu	1.6
88-01479	FKD 10-400-P7	10.0	15.5	3.550	3 x 66.3	g	4		10.0	Cu	1.5
88-01767	FDR 12,5-400-P7	12.5	18.0	3.070	3 x 77.1	g	4		10.0	Cu	2.1
88-01362	FKD 15-400-P7	15.0	23.3	2.370	3 x 99.5	h	6		15.0	Cu	2.2
88-01922	FDR 16,7-400-P7	16.7	24.1	2.300	3 x 102.9	h	6		13.0	Cu	1.7
88-01363	FKD 20-400-P7	20.0	31.0	1.780	3 x 132.6	h	10		19.0	Cu	2.6
88-01768	FDR 25-400-P7	25.0	36.1	1.530	3 x 154.2	h	10		21.0	Cu	3.9
88-01484	FKD 30-400-P7	30.0	46.5	1.190	3 x 198.9	m	10		19.0	Al	3.5
88-01923	FDR 33,3-400-P7	33.3	48.2	1.150	3 x 205.8	m	16		19.0	Al	3.5
88-02053	FDR 37,5-400-P7	37.5	54.5	1.020	3 x 232.8	n	16		23.0	Al	2.8
88-01782	FDR 40-400-P7	40.0	58.2	0.950	3 x 248.8	n	16		24.0	Al	2.8
88-01769	FDR 50-400-P7	50.0	72.2	0.770	3 x 308.4	n	16		27.0	Al	5.1

Standard Harmonic Filter Reactor - FDR/FKD - $V_N = 415\text{ V} / 50\text{ Hz} - p = 7\% - f_{res} = 189\text{ Hz}$

88-02034	FDR 6,25-415-P7	6.3	8.7	6.580	3 x 35.9	c	4		5.1	Cu	1.5
88-01937	FDR 12,5-415-P7	12.5	17.3	3.310	3 x 71.4	g	4		10.0	Cu	1.8
88-01938	FDR 25-415-P7	25.0	34.7	1.660	3 x 142.8	h	10		15.0	Cu	3.7
88-01930	FDR 50-415-P7	50.0	69.3	0.828	3 x 285.6	n	16		27.0	Al	5.3

Standard Harmonic Filter Reactor - FDR/FKD - $V_N = 440\text{ V} / 50\text{ Hz} - p = 7\% - f_{res} = 189\text{ Hz}$

88-02160	FDR 6,25-440-P7	6.3	8.3	7.360	3 x 32.1	e	4		6.0	Cu	1.5
88-02161	FDR 12,5-440-P7	12.5	16.5	3.680	3 x 64.2	g	4		9.5	Cu	2.6
88-01008	FKD 25-440-P7	25.0	34.2	1.780	3 x 132.8	k	10		21.0	Cu	3.8
88-01124	FKD 50-440-P7	50.0	68.4	0.890	3 x 265.6	n	16 / 2x6		25.0	Al	4.7

Standard Harmonic Filter Reactor - FDR/FKD - $V_N = 525\text{ V} / 50\text{ Hz} - p = 7\% - f_{res} = 189\text{ Hz}$

88-01801	FDR 6,25-525-P7	6.3	7.0	10.320	3 x 22.9	c	4		7.0	Cu	1.4
88-01802	FDR 12,5-525-P7	12.5	14.1	5.160	3 x 45.8	g	4		10.0	Cu	1.8
88-01080	FKD 20-525-P7	20.0	24.7	2.940	3 x 80.5	k	6		19.0	Cu	3.3
88-01838	FDR 25-525-P7	25.0	27.5	2.640	3 x 89.5	k	6		20.0	Cu	3.9
88-01872	FDR 50-525-P7	50.0	55.0	1.320	3 x 179.0	n	16		32.0	Al	3.1

Components

Standard Harmonic Filter Reactors

Article-No.	Type	Q [kvar]	I _N [A]	L [mH]	C [μF]	Size	Connection		Weight approx. [kg]	Winding material	Al/Cu Weight [kg]
							Cable [mm ²]	Terminal [mm ²]			

Standard Harmonic Filter Reactor - FDR/FKD - V_N = 690 V / 50 Hz - p = 7 % - fres = 189 Hz

88-01825	FKD 10-690-P7	10.0	8.9	10.700	3 x 22.1	g	4		10.0	Cu	on request
88-01932	FDR 25-690-P7	25.0	20.8	4.590	3 x 51.5	h	4		19.0	Cu	3.7
88-01933	FDR 50-690-P7	50.0	41.6	2.290	3 x 103.1	n	10		26.0	Al	4.5

Version: P7 (Detuning factor p = 7 %), 50 Hz

Permissible harmonics EN 61000-2-4 Class 3

Article-No.	Type	Q [kvar]	I _N [A]	L [mH]	C [μF]	Size	Connection		Weight approx. [kg]	Winding material	Al/Cu Weight [kg]
							Cable [mm ²]	Terminal [mm ²]			

Standard Harmonic Filter Reactor - FDR/FKD - V_N = 400 V / 50 Hz - p = 7 % - fres = 189 Hz

88-01776	FDR 12,5-400-P7-S3	12.5	18.0	3.070	3 x 77.1	g	4		13	Cu	3.1
88-01777	FDR 25-400-P7-S3	25	36.1	1.530	3 x 154.2	k	10		23	Cu	7.0
88-01778	FDR 50-400-P7-S3	50	72.2	0.766	3 x 308.4	o	25		35	Al	4.5

Standard Harmonic Filter Reactor - FDR/FKD - V_N = 690 V / 50 Hz - p = 7 % - fres = 189 Hz

88-01878	FDR 25-690-P7-S3	25	20.9	4.560	3 x 51.8	k	4		22	Cu	6.7
88-01879	FDR 50-690-P7-S3	50	41.8	2.280	3 x 103.6	o	10		22	Al	4.6

Version: P7 (Detuning factor p = 7 %), 60 Hz

Permissible harmonics EN 61000-2-4 Class 2

Article-No.	Type	Q [kvar]	I _N [A]	L [mH]	C [μF]	Size	Connection		Weight approx. [kg]	Winding material	Al/Cu Weight [kg]
							Cable lug [mm ²]	Terminal [mm ²]			

Standard Harmonic Filter Reactor - FDR/FKD - V_N = 230 V / 60 Hz - p = 7 % - fres = 227 Hz

88-01996	FDR 2,5-230-P7-60	2.5	6.2	4.260	3 x 38.5	a	4		4.0	Cu	on request
88-01997	FDR 5-230-P7-60	5.0	12.5	2.120	3 x 77.3	c	6		6.0	Cu	on request
88-01998	FDR 10-230-P7-60	10.0	25.0	1.060	3 x 154.6	f	6		9.0	Cu	on request
88-02140	FDR 12,5-230-P7-60	12.5	31.4	0.843	3 x 194.3	f	10		10.0	Cu	1.8
88-02001	FDR 20-230-P7-60	20.0	49.9	0.530	3 x 309.2	h	16		15.0	Cu	on request
88-01892	FDR 25-230-P7-60	25.0	62.2	0.430	3 x 385.5	h	16		21.0	Cu	2.3

Standard Harmonic Filter Reactor - FDR/FKD - V_N = 380 V / 60 Hz - p = 7 % - fres = 227 Hz

88-02179	FDR 12,5-380-P7-60	12.5	19.0	2.290	3 x 71.4	g	4		10.0	Cu	1.7
88-02180	FDR 25-380-P7-60	25.0	38.1	1.150	3 x 142.8	h	10		16.0	Cu	4.1
88-02181	FDR 50-380-P7-60	50.0	76.2	0.574	3 x 285.6	n	25		25.0	Al	3.9

Standard Harmonic Filter Reactor - FDR/FKD - V_N = 400 V / 60 Hz - p = 7 % - fres = 227 Hz

88-01963	FDR 12,5-400-P7-60	12.5	18.0	2.560	3 x 64.2	f	4		10.0	Cu	2.1
88-01964	FDR 25-400-P7-60	25.0	36.0	1.280	3 x 128.1	h	10		13.0	Cu	3.0
88-01965	FDR 50-400-P7-60	50.0	72.1	0.640	3 x 256.9	n	16		24.0	Al	4.5

Standard Harmonic Filter Reactor - FDR/FKD - V_N = 440 V / 60 Hz - p = 7 % - fres = 227 Hz

88-01914	FKD 6,25-440-P7-60	6.3	9.2	5.480	3 x 29.9	c	4		6.0	Cu	1.8
88-01795	FDR 7,5-440-P7-60	7.5	9.9	5.120	3 x 32.0	c	4		6.0	Cu	1.9
88-01883	FDR 12,5-440-P7-60	12.5	16.9	2.990	3 x 54.8	e	4		21.0	Cu	2.7
88-01796	FDR 15-440-P7-60	15.0	19.8	2.560	3 x 64.0	g	6		10.0	Cu	2.5
88-01884	FDR 25-440-P7-60	25.0	33.1	1.530	3 x 107.2	h	10		11.0	Cu	3.8
88-01875	FDR 50-440-P7-60	50.0	66.2	0.760	3 x 214.2	n	16		29.0	Al	on request

Components

Standard Harmonic Filter Reactors

Version: P7 (Detuning factor $p = 7\%$), 60 Hz

Permissible harmonics EN 61000-2-4 Class 2

Article-No.	Type	Q [kvar]	I_N [A]	L [mH]	C [μ F]	Size	Connection		Weight approx. [kg]	Winding material	Al/Cu Weight [kg]
							Cable lug [mm ²]	Terminal [mm ²]			

Standard Harmonic Filter Reactor - FDR/FKD - $V_N = 460\text{ V} / 60\text{ Hz} - p = 7\% - f_{res} = 227\text{ Hz}$

88-02123	FKD 2,5-460-P7-60	2.5	3.6	14.760	3 x 11.1	a	4		3.0	Cu	on request
88-02124	FKD 5-460-P7-60	5.0	6.7	7.910	3 x 20.7	c	4		4.5	Cu	on request
88-02125	FDR 10-460-P7-60	10.0	12.4	4.250	3 x 38.5	c	4		5.0	Cu	on request
88-01854	FDR 12,5-460-P7-60	12.5	15.5	3.410	3 x 48.1	g	6		10.0	Cu	1.2
88-01855	FDR 25-460-P7-60	25.0	31.1	1.700	3 x 96.2	h	10		21.0	Cu	3.7
88-01856	FDR 50-460-P7-60	50.0	62.1	0.850	3 x 192.4	n	16		27.0	Al	4.5

Standard Harmonic Filter Reactor - FDR/FKD - $V_N = 480\text{ V} / 60\text{ Hz} - p = 7\% - f_{res} = 227\text{ Hz}$

88-01962	FDR 12,5-480-P7-60	12.5	15.4	3.590	3 x 45.6	f	4		9.0	Cu	1.9
88-02056	FDR 25-480-P7-60	25.0	30.2	1.830	3 x 89.7	h	6		15.0	Cu	3.1
88-01858	FDR 50-480-P7-60	50.0	60.5	0.910	3 x 179.4	n	16		25.0	Al	3.7

Version: P8 (Detuning factor $p = 8\%$)

Permissible harmonics EN 61000-2-4 Class 2

Article-No.	Type	Q [kvar]	I_N [A]	L [mH]	C [μ F]	Size	Connection		Weight approx. [kg]	Winding material	Al/Cu Weight [kg]
							Cable lug [mm ²]	Terminal [mm ²]			

Standard Harmonic Filter Reactor - FDR/FKD - $V_N = 400\text{ V} / 50\text{ Hz} - p = 8\% - f_{res} = 177\text{ Hz}$

88-01678	FKD 2,5-400-P8	2.5	3.9	16.200	3 x 16.6	a	4		5.0	Cu	0.8
88-01941	FKD 3,13-400-P8	3.1	4.7	13.540	3 x 19.9	c	4		7.0	Cu	0.8
88-01518	FKD 5-400-P8	5.0	7.9	8.150	3 x 33.2	c	4		7.0	Cu	0.5
88-01492	FKD 6,25-400-P8	6.3	9.8	6.520	3 x 41.5	c	4		7.0	Cu	1.4
88-01519	FKD 7,5-400-P8	7.5	11.8	4.750	3 x 49.7	c	4		7.0	Cu	1.5
88-01520	FKD 10-400-P8	10.0	15.7	4.080	3 x 66.3	g	4		10.0	Cu	1.4
88-01770	FDR 12,5-400-P8	12.5	18.2	3.500	3 x 77.1	g	4		10.0	Cu	2.0
88-01381	FKD 15-400-P8	15.0	23.5	2.720	3 x 99.5	h	6		15.0	Cu	1.8
88-01926	FDR 16,7-400-P8	16.7	24.3	2.620	3 x 102.9	h	6		13.0	Cu	on request
88-01382	FKD 20-400-P8	20.0	31.4	2.040	3 x 132.6	h	10		19.0	Cu	4.0
88-01771	FDR 25-400-P8	25.0	36.5	1.750	3 x 154.2	h	10		19.0	Cu	3.7
88-01387	FKD 30-400-P8	30.0	47.0	1.350	3 x 198.9	m	10		19.0	Al	3.8
88-01927	FDR 33,3-400-P8	33.3	48.7	1.310	3 x 205.9	m	16		19.0	Al	3.8
88-02054	FDR 37,5-400-P8	37.5	54.9	1.160	3 x 231.9	n	16		24.0	Al	2.7
88-01781	FDR 40-400-P8	40.0	58.3	1.090	3 x 246.6	n	16		24.0	Al	3.0
88-01772	FDR 50-400-P8	50.0	72.9	0.874	3 x 308.4	n	16		26.0	Al	4.7

Standard Harmonic Filter Reactor - FDR/FKD - $V_N = 480\text{ V} / 50\text{ Hz} - p = 8\% - f_{res} = 177\text{ Hz}$

88-01985	FDR 25-480-P8	25.0	30.5	2.510	3 x 107.4	h	10		16.0	on request	on request
88-01986	FDR 50-480-P8	50.0	61.0	1.250	3 x 214.8	n	16		24.0	Al	3.1

Standard Harmonic Filter Reactor - FDR/FKD - $V_N = 525\text{ V} / 50\text{ Hz} - p = 8\% - f_{res} = 177\text{ Hz}$

88-01845	FKD 20-525-P8	20.0	25.0	3.350	3 x 80.5	k	6		18.0	Cu	3.5
88-01840	FDR 25-525-P8	25.0	27.8	3.010	3 x 89.5	k	6		18.0	Cu	3.7
88-01846	FDR 30-525-P8	30.0	35.0	2.390	3 x 112.7	k	10		21.0	Cu	on request
88-01871	FDR 50-525-P8	50.0	55.6	1.510	3 x 179.0	o	16		32.0	Al	3.3

Components

Standard Harmonic Filter Reactors

Version: P8 (Detuning factor $p = 8\%$)

Permissible harmonics EN 61000-2-4 Class 2

Article-No.	Type	Q [kvar]	I_N [A]	L [mH]	C [μ F]	Size	Connection		Weight approx. [kg]	Winding material	Al/Cu Weight [kg]
							Cable lug [mm ²]	Terminal [mm ²]			

Standard Harmonic Filter Reactor - FDR/FKD - $V_N = 690\text{ V} / 50\text{ Hz} - p = 8\% - f_{res} = 177\text{ Hz}$

88-01807	FKD 25-690-P8	25.0	22.6	4.870	3 x 55.3	k	4		18.0	Cu	3.7
88-01912	FDR 50-690-P8	50.0	42.1	2.610	3 x 103.1	n	10		27.0	Al	4.8

Version: P1 (Detuning factor $p = 14\%$), 50 Hz

Permissible harmonics EN 61000-2-4 Class 2

Article-No.	Type	Q [kvar]	I_N [A]	L [mH]	C [μ F]	Size	Connection		Weight approx. [kg]	Winding material	Al/Cu Weight [kg]
							Cable lug [mm ²]	Terminal [mm ²]			

Standard Harmonic Filter Reactor - FDR/FKD - $V_N = 230\text{ V} / 50\text{ Hz} - p = 14\% - f_{res} = 134\text{ Hz}$

88-02020	FDR 15-230-P1	15.0	37.7	1.750	3 x 260.3	k	10		17.0	Cu	2.6
88-01868	FDR 30-230-P1	30.0	75.6	0.880	3 x 519.9	n	16		34.0	Al	4.3

Standard Harmonic Filter Reactor - FDR/FKD - $V_N = 400\text{ V} / 50\text{ Hz} - p = 14\% - f_{res} = 134\text{ Hz}$

88-01834	FDR 3,13-400-P1	3.1	4.2	28.300	3 x 16.6	c	4		5.0	Cu	0.9
88-02186	FDR 6,25-400-P1	6.3	9.1	13.100	3 x 35.9	f	4		7.0	Cu	1.4
88-01979	FDR 7,5-400-P1	7.5	11.0	10.800	3 x 43.4	g	4		10.0	Cu	2.1
88-01695	FDR 10-400-P1	10.0	15.1	7.860	3 x 59.8	g	4		11.0	Cu	3.2
88-01168	FDR 12,5-400-P1	12.5	18.1	6.590	3 x 71.4	h	4		13.0	Cu	2.5
88-02187	FDR 15-400-P1	15.0	22.7	5.250	3 x 89.6	h	4		15.0	Cu	4.0
88-02177	FDR 16,7-400-P1	16.7	24.2	4.910	3 x 95.8	h	4		15.0	Cu	4.0
88-01038	FDR 20-400-P1	20.0	28.6	4.160	3 x 113.1	k	6		21.0	Cu	5.7
88-01171	FDR 25-400-P1	25.0	36.1	3.290	3 x 142.8	n	10		25.0	Al	4.5
88-01039	FDR 30-400-P1	30.0	44.1	2.700	3 x 174.3	n	10		26.0	Al	4.3
88-01925	FDR 33,3-400-P1	33.3	48.2	2.470	3 x 190.7	n	16		25.0	Al	4.5
88-02176	FDR 37,5-400-P1	37.5	54.2	2.200	3 x 214.2	o	16		32.0	Al	5.3
88-02175	FDR 40-400-P1	40.0	58.8	2.020	3 x 232.4	o	16		32.0	Al	5.3
88-02174	FDR 50-400-P1	50.0	71.9	1.600	3 x 285.6	o	16		33.0	Al	5.5

Standard Harmonic Filter Reactor - FDR/FKD - $V_N = 415\text{ V} / 50\text{ Hz} - p = 14\% - f_{res} = 134\text{ Hz}$

88-01956	FDR 25-415-P1	25.0	34.6	3.440	3 x 132.6	m	10		24.0	Cu	8.9
88-01957	FDR 50-415-P1	50.0	69.6	1.770	3 x 265.2	o	16		35.0	Al	4.8

Standard Harmonic Filter Reactor - FDR/FKD - $V_N = 440\text{ V} / 50\text{ Hz} - p = 14\% - f_{res} = 134\text{ Hz}$

88-02041	FDR 25-440-P1	25.0	32.8	3.980	3 x 118.0	n	10		25.0	Al	3.4
88-02007	FDR 50-440-P1	50.0	66.9	1.960	3 x 240.5	p	16		41.0	Al	5.2

Standard Harmonic Filter Reactor - FDR/FKD - $V_N = 480\text{ V} / 50\text{ Hz} - p = 14\% - f_{res} = 134\text{ Hz}$

88-02143	FDR 25-480-P1	25.0	30.4	4.690	3 x 100.2	n	6		25.0	Al	4,5
88-02144	FDR 50-480-P1	50.0	60.5	2.360	3 x 199.3	p	16		40.0	Al	7,4

Standard Harmonic Filter Reactor - FDR/FKD - $V_N = 525\text{ V} / 50\text{ Hz} - p = 14\% - f_{res} = 134\text{ Hz}$

88-02039	FDR 12,5-525-P1	12.5	15.1	10.400	3 x 45.4	h	4		14.0	Cu	3.7
88-01960	FDR 25-525-P1	25.0	27.9	5.570	3 x 84.4	m	6		22.0	Cu	5.9
88-01900	FDR 50-525-P1	50.0	55.8	2.790	3 x 168.8	o	16		33.0	Al	3.9

Components

Standard Harmonic Filter Reactors

Version: P1 (Detuning factor $p = 14\%$), 50 Hz

Permissible harmonics EN 61000-2-4 Class 2

Article-No.	Type	Q [kvar]	I_N [A]	L [mH]	C [μ F]	Size	Connection		Weight approx. [kg]	Winding material	Al/Cu Weight [kg]
							Cable [mm ²]	Terminal [mm ²]			

Standard Harmonic Filter Reactor - FDR/FKD - $V_N = 690\text{ V} / 50\text{ Hz} - p = 14\% - \text{fres} = 134\text{ Hz}$

88-02122	FDR 12,5-690-P1	12.5	9.6	21.300	3 x 22.1	h	4		19.0	Cu	on request
88-02120	FDR 20-690-P1	20.0	16.9	12.200	3 x 38.7	k	4		18.0	Cu	on request
88-01842	FDR 25-690-P1	25.0	21.7	9.130	3 x 50.0	n	4		27.0	Cu	5.1
88-02257	FDR 50-690-P1	50.0	43.4	4.570	3 x 99.9	p	10 / 2x4		33.0	Al	10.5

Version: P5 (Detuning factor $p = 5.67\%$)

$I_{5_{\max}} = 68\%$, $I_{7_{\max}} = 19\%$

Article-No.	Type	Q [kvar]	I_N [A]	L [mH]	C [μ F]	Size	Connection		Weight approx. [kg]	Winding material	Al/Cu Weight [kg]
							Cable [mm ²]	Terminal [mm ²]			

Standard Harmonic Filter Reactor - FDR/FKD - $V_N = 400\text{ V} / 50\text{ Hz} - p = 5.67\% - \text{fres} = 210\text{ Hz}$

88-02141	FDR 25-400-P5	25.0	35.8	1.230	3 x 155.2	n	10		23.0	Al	2.8
88-02142	FDR 50-400-P5	50.0	71.6	0.617	3 x 310.4	o	25		33.0	Al	7.2

Version: P5 (Detuning factor $p = 5.67\%$), 50 Hz

Permissible harmonics EN 61000-2-4 Class 3

Article-No.	Type	Q [kvar]	I_N [A]	L [mH]	C [μ F]	Size	Connection		Weight approx. [kg]	Winding material	Al/Cu Weight [kg]
							Cable [mm ²]	Terminal [mm ²]			

Standard Harmonic Filter Reactor - FDR/FKD - $V_N = 400\text{ V} / 50\text{ Hz} - p = 5.67\% - \text{fres} = 210\text{ Hz}$

88-01833	FDR 25-400-P5-S3	25	35.7	1.240	3x154.6	n	10		25	Al	3.1
88-02022	FDR 50-400-P5-S3	50	71.2	0.621	3x308.4	p	35		48	Cu	14.0

Standard Harmonic Filter Reactor - FDR/FKD - $V_N = 690\text{ V} / 50\text{ Hz} - p = 5.67\% - \text{fres} = 210\text{ Hz}$

88-02063	FDR 25-690-P5-S3	25	20.5	3.720	3x51.4	n	6		26	Al	3.7
88-02064	FDR 50-690-P5-S3	50	41	1.860	3x103.1	p	16		43	Al	6.9

Components

Standard Harmonic Filter Reactors

Dimensions

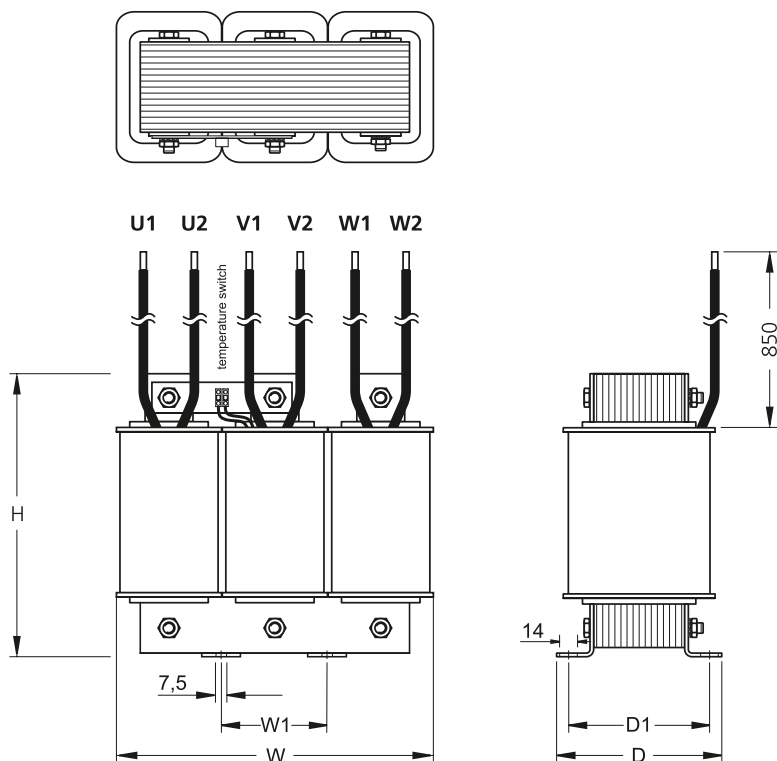

Core 3UI	Dimensions [mm]				
	W_{max}	W1	D_{max}	D1	$H_{\pm 3.0}$
a	120	40	83	63	110
c	150	50	97	77	132
e	180	60	91	71	156
f	180	60	101	81	156
g	180	60	111	91	156
h	204	68	121	101	177
k	228	76	128	108	197
m	264	88	114	94	229
n	264	88	140	120	230
o	300	100	150	129	265
p	300	100	165	144	265

Components

Standard Harmonic Filter Reactors

1



Components

Power Factor Control Relays



Components Power Factor Control Relays

The Reactive Power control Relay for maximum operational reliability.
Simple to install, easy to operate and automatic 'plug and play' start-up.

Characteristics that count

FRAKO's intelligent reactive power control relays automatically adjust themselves to suit the power factor correction system and the network that they serve. This automatically eliminates the risk of faulty programming.

Incorrect connections or inappropriate locations for the instrument transformers are identified and indicated, therefore making time-consuming and expensive troubleshooting unnecessary. The patented characteristic curve controls the set target $\cos \varphi$ as a minimum value under normal load while simultaneously preventing overcorrection under low load conditions. This reliably prevents costs for reactive power arising and reduces the risk of network disruptions.

The control relay's intelligent mode of operation ensures that the target parameters are controlled and maintained with the lowest possible number of switching cycles. This minimizes wear of the power factor correction system and reduces disturbances to the network.

Some control relay versions have a trip function to protect the power factor correction system from excessive levels of harmonics.

Last not least, our customers appreciate the user-friendly operation of our reactive power control relays.

Application Recommendations

Consumer network with regulation on inductive target $\cos \varphi$ Quadrant: consumption – inductive	RM 2106 / RM 2112 see from page 36 PQC see from page 39
Consumer- and electricity producer networks with regulation in all 4 quadrants	PQC see from page 39
Measurement value logging of voltage and current (medium voltage)	PQC see from page 39
Detuned Power Factor Correction Systems with detuning factors $< 7\%$ or networks with sporadically higher harmonic voltages according to EN 61000-2-4 class 2	PQC see from page 39
Part dynamic Power and dynamic Factor Correction Systems	PFC-12TR-1, PFC-12TR-1-RS485 see from page 36

Components

Power Factor Control Relays

Features / Technical Data

Category	Basic	
	RM 2106	RM 2112
Type		
Article-No. (German, English)	38-00320	38-00340
Voltage measurement	L-N	
Operating/Measurement voltage [V]	220 - 240	
Frequency [Hz]	50 / 60	
Current measurement	Single phase	
Operating current min. [mA] man. programming	20	
Operating current min. [mA] automatic detection	20	
Current transformer X/...A	1 - 5	
Connection type	Man/Auto	
Target cos φ	0.85 ind. - 1	
Characteristics settings	Fixed	
Number of characteristics	1	
Switching sequence	Man/Auto	
Number of active switching outputs	Man/Auto	
Relay contacts	6	12
Loading capacity of the relay contacts	230 V / 950 VA	
Switching time delay of the relay contacts	Fixed, 60 sec.	
Real switching time delay of the relay contacts	Optimised, depending on the load changes	
Switching time (discharge time) of the relay contacts	Fixed 60 sec.	
Fault signal contacts	1 relay switch contact selectable	
Loading capacity of the fault signal contacts	230 V / 950 VA	
Dimensions W x H x D [mm]	144 x 144 x 40	
Panel cut out [mm]	138 x 138	
Ingress protection front	IP50 (IP54*)	
Ingress protection backside	IP20	
Weight (net) [kg]	0.8	

* when using a sealing ring (optional)

Components

Power Factor Control Relays

Category	Dynamic	
	PFC-12TR-1	PFC-12TR-1-RS485
Type		
Article-No.	39-29060	39-29061
Supply voltage (L-N / L-L)	110-440 V AC, ± 15%	
Consumption	max. 5 VA	
Display	128 x 64 Pixel	
Voltage measurement	L-N / L-L	
Voltage ranges	30-440 V AC L-N / 50-760 V AC L-L	
Tolerance	-15 / +10 %	
Frequency	42 - 80 Hz	
Sampling rate	10 kHz (bei 50 Hz)	
Current measurement	Single phase	
Current ranges	x / 5 A (x / 1 A)	
Response current	50 mA (10 mA)	
Maximum current	6 A	
Consumption of current measurement	ca. 0.2 VA	
Switching outputs (relay)	12	
Switching capacity	max. 250 V / 1.000 W	
Fusing	10 AT	
Mechanical lifetime	> 10 ⁷ switching cycles	
Electrical lifetime	> 10 ⁵ switching cycles	
Switching outputs (transistor)	12	
Switching voltage	5 - 30 V DC	
Switching current	max. 50 mA	
Alarm relay (switching capacity)	1 (max. 250 V / 1.000 W)	
Digital input (tariff switching)	-	•
Interface (communication)	-	RS485
Supported communication protocols	-	Modbus RTU, Modbus KTR, ASCII Out, Master Mode, Slave Mode, Slave Hybrid
Controller Networking	-	•
Dimensions (W x H x D)	144 x 144 x 53 mm	
Weight	1 000 g	
Protection degree according to IEC 60529	front IP54, back IP20	
Mounting	front plate	
Connection cross-sections	0.08-2.5 mm ² (solid, stranded and fine-stranded), 1.5 mm ² (pin cable lug, wire end sleeve)	
Operating temperature range	-10 ... +55 °C	
Relative humidity	max. 95% without condensation	
Altitude	max. 2 000 m	
Degree of pollution	2	
Mounting position	any	
EMI	Guidelines 2004/108/EG & 2006/95/EG	
Device security	IEC/EN 61010-1 & IEC/EN 61010-1-08	
Protection class	I (with protective conductor)	
Interference immunity	DIN EN (IEC) 61326-1, industrial environment	
Emitted interference	DIN EN (IEC) 61326-1, class B: living environment, DIN EN (IEC) 61326-1, class A: industrial environment	

Components

Power Factor Control Relays

1

Operating mode displays

Category	Basic	
	RM 2106	RM 2112
Type	RM 2106	RM 2112
Actual cos φ	Instantaneous value	Instantaneous value
Target cos φ	•	•
Active current [A]	•	•
Reactive current [A]	•	•
Apparent current [A]	Instantaneous value	Instantaneous value
Capacitor power per step	Value	Value
Connected capacitor steps	•	•
Harmonic voltage [%]	THDv	THDv
Lack of capacity	Alarm can be deactivated	Alarm can be deactivated
Defective capacitor steps	Alarm	Alarm
Switching operations threshold value	Alarm	Alarm
Undervoltage	Alarm Switch-off	Alarm Switch-off
Overcurrent	Alarm switch-off	Alarm switch-off
Minimum current	Message switch-off	Message switch-off
Harmonic voltage limit	Alarm	Alarm

Category	Dynamic	
	PFC-12TR-1	PFC-12TR-1-RS485
Type	PFC-12TR-1	PFC-12TR-1-RS485
Actual cos φ	Instantaneous and average value	Instantaneous and average value
Target cos φ	•	•
Active current [A]	•	•
Reactive current [A]	•	•
Apparent current [A]	Instantaneous and peak value	Instantaneous and peak value
Capacitor power per step	•	•
Connected capacitor steps	•	•
Harmonic voltage [%]	3., 5., 7., 9., 11., 13., 15., 17., 19.	3., 5., 7., 9., 11., 13., 15., 17., 19.
Lack of capacity	Alarm can be deactivated	Alarm can be deactivated
Defective capacitor steps	-	-
Switching operations threshold value	-	-
Undervoltage	Alarm Switch-off - can be deactivated	Alarm Switch-off - can be deactivated
Overcurrent	Alarm - can be deactivated	Alarm - can be deactivated
Minimum current	Alarm switch-off - can be deactivated	Alarm switch-off - can be deactivated
Harmonic voltage limit	Alarm - can be deactivated	Alarm - can be deactivated

Dimensions Dimensional drawing RM 2106 (RM 2112)

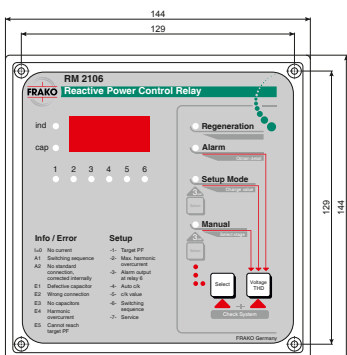

Dimensions Dimensional drawing PFC-12TR-1/PFC-12TR-1-RS485

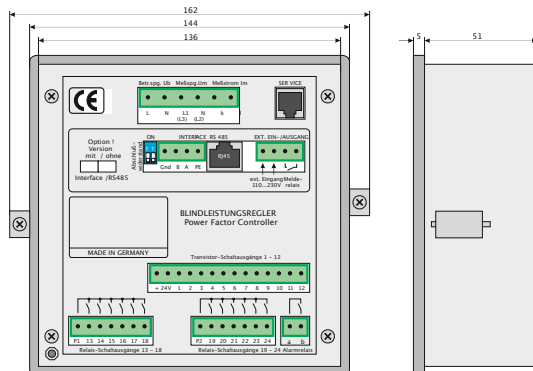

All dimensions in mm

Components

Power Quality Controller



PQC Power Quality Controller

The reactive power control relay for maximum operational reliability with power quality monitoring

The PQC Power Quality Controller adds powerful new functionality to the well-known strengths of the FRAKO Reactive Power Control Relays to meet the challenges posed by state-of-the-art power quality systems. With its built-in microprocessor, the PQC handles tasks over and above classical power factor correction. In particular, new protective mechanisms have been incorporated to safeguard not only the network itself but also the system that corrects its power factor. The PQC thus monitors the relevant parameters that can cause disruptions in the network, and gives alarms if they go beyond the limits set to ensure compliance with technical standards. In addition, the PQC also protects the power factor correction system responsible for the network, shutting it down if it becomes overloaded. This significantly reduces the risk of upsets occurring within that system. Defective or partially defective capacitor stages are identified and withdrawn from the power factor correction process. An extremely flexible alarm management function ensures that alarm messages are sent to where they are needed, as appropriate to the event concerned. The possibility of parameterizing each individual controller enables the PQC to be used anywhere, making it the best possible instrument for controlling power quality in contemporary industrial supply networks.

The PQC is characterized by user-friendly features such as simple installation, intuitive operation and the automatic start-up already known from FRAKO Reactive Power Control Relays. Its integrated self-monitoring function improves long-term operational reliability, thus helping to reduce costs and minimize the risk of network disruptions.

Key features

- 1- or 3-phase measurement
- 4-quadrant control
- 6 or 12 switching outputs + 1 alarm contact
- 5 parameterizable control curves
- Graphical user interface with plain text menu in choice of languages
- Integrated monitoring of system parameters with alarm management function

Recommended applications

The PQC is suitable for 4-quadrant power factor correction in:

- Consumer networks
- Power generation networks
- Low and medium voltage networks
- Power factor correction systems with or without detuning

For further Power Factor Control Relays please see page 35

Components

Power Quality Controller

1

Instrument versions

The PQC is designed primarily for mounting in a 138 x 138 mm cutout in the front of a control panel. Different versions of the instrument can be selected to suit the required application. These differ essentially according to:

- Instrument power supply
- Number of measurement inputs
- Number and rating of switching outputs

Combinations of these parameters mean that 6 different basic types are available:

Instruments with 100–240 V, 50/60 Hz power supplies

Type	Measurement inputs	Switching outputs
PQC 1202401-0	1 V/I	12 x 250 V / 3 A
PQC 1202403-0	3 V/I	12 x 250 V / 3 A
PQC 0602401-0	1 V/I	6 x 250 V / 3 A

Instruments with 100–480 V, 50/60 Hz power supplies

Type	Measurement inputs	Switching outputs
PQC 1204801-0	1 V/I	12 x 250 V / 3 A
PQC 1204803-0	3 V/I	12 x 250 V / 3 A
PQC 0614801-0	1 V/I	6 x 440 V / 3 A

The inputs for the measured voltage are designed for 100-690 V, 50/60 Hz; those for the measured current are designed for use with x/1A or x/5A current transformers.

Operating the PQC

The PQC has a backlit monochrome LC display with 128 x 64 pixels, plus 5 keys for navigating the plain language (German, English or French) menu.

The menu is structured in an intuitive way that makes it easy to program the instrument. An overview of the controller in the display shows the key information for the individual phases together with the status of the switching outputs. The operator is thus given all relevant information on the state of the power factor correction system at a glance. An intelligent alarm management function alerts the operator to critical conditions, either by messages in the display, via the alarm contact, or both, as desired.

Commissioning the PQC

When first started up, the PQC automatically determines the system configuration to which it is connected plus the switching outputs in use with their respective capacitance ratings (in kvar). The operator selects the appropriate control profile for the application or parameterizes the PQC to meet the required specifications. Five control profiles—specially developed for the most frequently encountered applications—are saved in the instrument before it leaves the factory. On completion of the start-up procedure, the PQC switches the connected capacitor stages in or out according to the selected control curve.

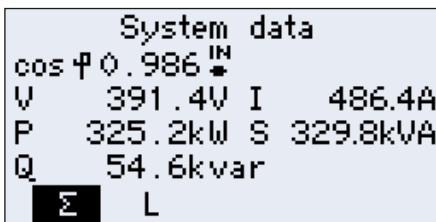

Network variables

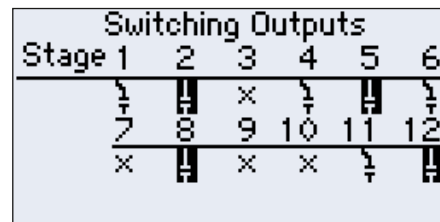

Status switching outputs

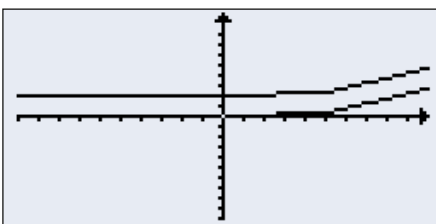

Control diagram with real time control characteristic

Components

Power Quality Controller

Features / Technical Data

Category	1-phase 12 stages	3-phase 12 stages	1-phase 6 stages	1-phase 12 stages	3-phase 12 stages	1-phase 6 stages
Type	PQC 1202401-0	PQC 1202403-0	PQC 0602401-0	PQC 1204801-0	PQC 1204803-0	PQC 0614801-0
Plain language selection (German/English/French)	• / • / •					
Extended function option	• (**)					
Article No.	38-00400	38-00401	38-00402	38-00406	38-00407	38-00410
Voltage measurement	L-N / L-L					
Measured voltage [V]	100 - 690			100 - 690 ****		
Operating voltage [V]	100 - 240			100 - 480		
Network frequency [Hz]	50 / 60					
Currents measured	1	3	1	1	3	1
Min. response current [mA], manual programming	20					
Min. response current [mA], automatic identification	20					
Current transformer x/...A	1 - 5					
Connection type	Man/Auto	Man	Man/Auto	Man/Auto	Man	Man/Auto
Target cos φ (ind./cap.)	0.800 (ind.) - 0.900 (cap.)					
Resolution (target cos φ)	0.01					
Control characteristic curve setting	Variable					
Number of control curves	5					
Control selectable from Lx/Ly/Lz	• / - / -	• / • / •	• / - / -	• / - / -	• / • / •	• / - / -
Switching sequence	Man/Auto					
Determining number of active switching outputs	Man/Auto					
Number of fixed stages programmable	3					
Relay switching contacts	12	12	6	12	12	6
Relay switching contact load rating	250 V / 750 VA					440 V / 1320 VA UL/CSA 3 A - 250 VAC / 30 VDC
Relay contact switching delay	Adjustable 5 - 500 s					
Effective relay contact switching delay	Optimized to match load changes					
Relay contact switched- off time (discharge time)	Adjustable 5 - 900 s					
Alarm function	Display / message / 1 volt-free NO contact					
Alarm switching contact load rating	250 V / 3 A					
Self-diagnosis	•					

Components

Power Quality Controller

1

Category	1-phase 12 stages	3-phase 12 stages	1-phase 6 stages	1-phase 12 stages	3-phase 12 stages	1-phase 6 stages
Type	PQC 1202401-0	PQC 1202403-0	PQC 0602401-0	PQC 1204801-0	PQC 1204803-0	PQC 0614801-0
Dimensions W x H x D [mm]	144 x 144 x 70					
Panel cutout dimensions [mm]	138 x 138					
Ingress protection, front	IP50 (IP54***)					
Ingress protection, rear	IP20					
Net weight [kg]	0.77					
Display	Monochrome backlit display, 128 x 64 pixels					
Start-up Wizard	•					
Measurement (frequency [kHz] / continuous)	12.5 / •					
Momentary cos φ	•					
Target cos φ	•					
Apparent current	•					
Capacitor current (overcurrent)	•					
Active [kW] / Reactive [kvar] / Apparent [kVA] power	• / • / •					
Corrective power still lacking (kvar)	•					
Capacitor power per stage	•					
Number of capacitor stages switched in	•					
Network voltage L-L [V]	•					
Harmonic voltage [%]	1 st –19 th 1 x manual spectrum analysis 0...2.5 kHz (°, °)					
Harmonic current [%]	1 st –19 th 1 x manual spectrum analysis 0...2.5 kHz (°, °)					
Switching cycles per stage	•					
Corrective power lacking (cos φ alarm)	Alarm (can be disabled)					
Defective capacitor stages	•					
Maximum number of switching cycles	Alarm					
Undervoltage	Alarm Shutdown					
Overcurrent	Alarm Shutdown (can be disabled)					
Undercurrent	Message Shutdown					
Harmonic voltage limits	Alarm Shutdown					
Thermal trip	• **					
Power failure detection	adjustable from 1/2 cycle to full cycle; de-energizes all active capacitor stages, automatically restarts when power resumes					
Stage monitoring	Monitoring of kvar loss per stage, adjustable 0...95 %					
Diagrammatic spectrum visualization	•					
Diagrammatic switching cycle visualization	•					

Components

Power Quality Controller

Category	1-phase 12 stages	3-phase 12 stages	1-phase 6 stages	1-phase 12 stages	3-phase 12 stages	1-phase 6 stages
Type	PQC 1202401-0	PQC 1202403-0	PQC 0602401-0	PQC 1204801-0	PQC 1204803-0	PQC 0614801-0
Diagrammatic stage power visualization	•					
Control characteristic curve visualization	•					
Firmware function update	• *					

* possible with USB cable, ** see different PQC types, *** IP54 upgrade kit, **** UL 600 V AC

vi Advance indication for harmonics analysis, v 2,5 kHz ~ 50th harmonic (50 Hz) ~ 40th harmonic (60 Hz)

Different types:

Category	1-phase 12 stages	3-phase 12 stages	1-phase 6 stages	1-phase 12 stages (UL)	3-phase 12 stages (UL)	1-phase 6 stages (UL)
----------	----------------------	----------------------	---------------------	---------------------------	---------------------------	--------------------------

Modbus RTU (RS-485) interface:

Type	PQC 1202401-20	PQC 1202403-20	PQC 0602401-20	PQC 1204801-20	PQC 1204803-20	PQC 0614801-20
Article-No.	38-00404	38-00412	38-00417	38-00422	38-00427	38-00432

Temperature and I/O*

Type	PQC 1202401-01	PQC 1202403-01	PQC 0602401-01	PQC 1204801-01	PQC 1204803-01	PQC 0614801-01
Article-No.	38-00403	38-00411	38-00416	38-00421	38-00426	38-00431

Modbus TCP (IoT) interface*

Type	PQC 1202401-30	PQC 1202403-30	PQC 0602401-30
Article-No.	38-00408	38-00414	38-00419

Modbus RTU (RS-485) interface + temperature and I/O

Type	PQC 1202401-21	PQC 1202403-21	PQC 0602401-21
Article-No.	38-00405	38-00413	38-00418

Modbus TCP (IoT) interface + temperature and I/O

Type	PQC 1202401-31	PQC 1202403-31	PQC 0602401-31
Article-No.	38-00409	38-00415	38-00420

*Advanced temperature and I/O extension:

This option consists of 3 temperature measurement inputs, which can be wired with a PT100 or PT1000 and 2 NTC's. For each of the 3 temperature sensors connected, an individual threshold value can be set. 5 digital in- and outputs (I/O) are additionally available, which are individually configurable. The digital in- and outputs need an external supply voltage of 5 ... 24 V DC and can be loaded with 100 mA per output.

Application example:

- Fan control (temperature detection)
- Temperature monitoring
- Automatic switching of relay profiles 1 and 2 (only I/O 1)
- Individually configurable outputs (e.g. to a process control system (PLC)) for status indication and selected alarms

*IoT (Internet of Things):

With this option, systems can be networked via the REST interface or the Modbus TCP/IP Ethernet protocol (RJ-45 connector). A web server with system parameters is also available.

Accessories:

Article-No.	20-50015	IP54 seal set for PQC
-------------	----------	-----------------------

Components

Power Quality Controller

Dimensions

Dimensional drawing PQC

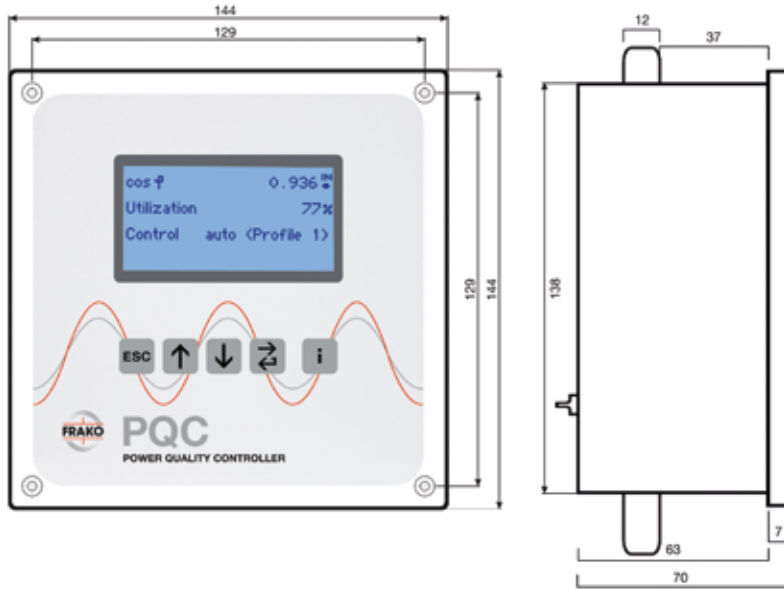

All dimensions in mm

Components

Capacitor Switching Contactors for Power Factor Correction Systems with or without reactors



K3-...K... / K3-...A...

Capacitor Switching Contactors for Power Factor Correction Systems with or without reactors

Switching Power Capacitors safely –
Capacitor Switching Contactors for any application.

- Safe switching of capacitor stages with or without reactors
- Bounce-free switching contacts
- Wear-free contact material
- Long service life and a high number of switching operations

Application Recommendations

Depending on the application appropriate switching devices are needed for the switching of power factor correction capacitors.

During the switching of Power Capacitors a peak inrush current of 200 times of the rated current can occur. In order to limit the inrush current and to protect switching devices and capacitors, capacitor switching contactors type K3-...K with leading transition contacts are used. To limit the inrush current to $<70 \times I_N$, damping resistors are used.

In case of detuned power factor correction systems the high inrush current is damped by the inductance of the harmonic filter reactor. In those applications capacitor switching contactors type K3-...A are used. Those contactors are made of a special contact material.

Components

Capacitor Switching Contactors for Power Factor Correction Systems with or without reactors

General Technical Data

Main Contacts		Type	K3-18	K3-24	K3-32	K3-50	K3-62	K3-74	K3-90	K3-115
Max. ambient temperature										
Operation	open	[°C]	-40 to +60 (+90) ¹⁾							
	enclosed	[°C]	-40 to +40							
Storage		[°C]	-50 to +90							
Short circuit protection										
for contactors without thermal overload relay										
Coordination-type „1“ according to IEC 947-4-1										
Contact welding without hazard of persons										
Max. fuse size	gL (gG)	[A]	100	100	100	160	160	200	200	250
Electrical endurance										
Switching cycles			80.000	80.000	80.000	80.000	80.000	80.000	80.000	80.000
short-time withstand current	10s-current	[A]	144	184	240	360	504	592	680	880
Power loss per pole	at I _g /AC3 400 V	[W]	0.5	0.7	1.3	2.2	3.9	5.5	4.3	6.0

¹⁾ With reduced control voltage range 0.9 up to 1.0 U_s and with reduced rated current I_g/AC1 according to I_g/AC3

Mounting Instructions

In the area of capacitor switching contactors only self-extinguishing material and material of low inflammability may be used, as abnormal temperatures in the area of the resistor spirals, in case of a fault, cannot be excluded.

Typical Circuit Diagram

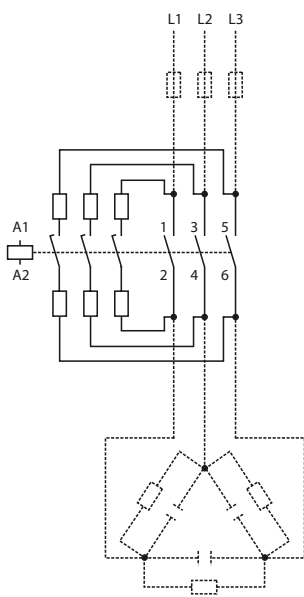

K3-...K...

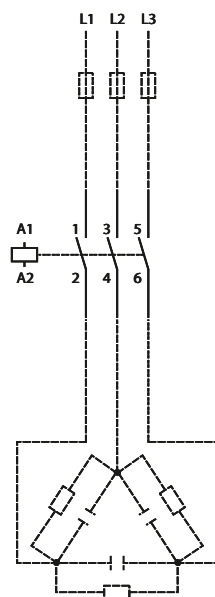

K3-...A...

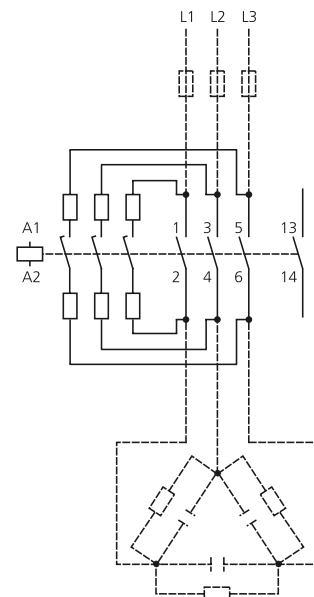

K3-18NBK

Components

Capacitor Switching Contactors for Power Factor Correction Systems with or without reactors

Technical Data

Article- No.	Type	Rated operational power at 50 / 60 Hz						Aux. contacts			Weight approx. [kg/pc.]
		Ambient temperature						built-in			
		50 °C			60 °C			NO	NC	Pcs.	
Coil voltage 220-240 V, 50 Hz		380 V	415 V	660 V	380 V	415 V	660 V				
230-264 V, 60 Hz		400 V	440 V	690 V	400 V	440 V	690 V				
		[kvar]	[kvar]	[kvar]	[kvar]	[kvar]	[kvar]				

Type K3-...A

89-00288	K3-18ND10 230	12.5	13	20	12.5	13	20	1	-	4 ²⁾	0.3
89-00289	K3-24A00 230	20	22	33	20	22	33	-	-	6 ³⁾	0.5
89-00290	K3-32A00 230	25	27	41	25	27	41	-	-	6 ³⁾	0.5
89-00291	K3-50A00 230	33.3	36	55	33.3	36	55	-	-	6 ³⁾	0.9
89-00292	K3-62A00 230	50	53	82	50	53	82	-	-	6 ³⁾	0.9
89-00293	K3-74A00 230	75 ⁴⁾	75 ⁴⁾	100 ⁴⁾	60	64	100	-	-	6 ³⁾	0.9
89-00358	K3-90A00 230	80	82	120	75	77	120	-	-	9 ⁵⁾	2.2
89-00359	K3-115A00 230	100 ⁶⁾	103 ⁶⁾	148 ⁶⁾	90 ⁶⁾	93 ⁶⁾	148 ⁶⁾	-	-	9 ⁵⁾	2.2

Type K3-...K

89-00469	K3-18NBK10 230	0-12.5	0-13	0-20	0-12.5	0-13	0-20	1	-	1 ²⁾	0.4
89-00279	K3-24K00 230	10-20	10.5-22	17-33	10-20	10.5-22	17-33	-	-	3 ³⁾	0.7
89-00278	K3-32K00 230	10-25	10.5-27	17-41	10-25	10.5-27	17-41	-	-	3 ³⁾	0.7
89-00277	K3-50K00 230	20-33.3	23-36	36-55	20-33.3	23-36	36-55	-	-	3 ³⁾	1.0
89-00276	K3-62K00 230	20-50	23-53	36-82	20-50	23-53	36-82	-	-	3 ³⁾	1.0
89-00286	K3-74K00 230	20-75 ⁴⁾	23-75 ⁴⁾	36-120 ⁴⁾	20-60	23-64	36-100	-	-	3 ³⁾	1.0
89-00356	K3-90K00 230	33-80	36-82	57-120	33-75	36-77	57-120	-	-	6 ⁵⁾	2.3
89-00357	K3-115K00 230	33-100 ⁶⁾	36-103 ⁶⁾	57-148 ⁶⁾	33-90 ⁶⁾	36-93 ⁶⁾	57-148 ⁶⁾	-	-	6 ⁵⁾	2.3

²⁾ 1HN.. or HA.. snap-on ³⁾ 1HN .. or HA.. snap-on + 2HB.. for side mounting

⁴⁾ Consider the max. thermal current of the contactor K3-74: I_{th} 130 A ⁵⁾ 2HB.. on the left or right side and 4HN.. or HA.. snap-on

⁶⁾ Consider the min. cross-section of conductor at max. load

Specification: Contactors K3-..K are suitable for switching low-inductive and low-loss capacitors in capacitor banks (IEC70 and 831, VDE 0560) without and with reactors.

Capacitor switching contactors are fitted with leading auxiliary contacts and damping resistors, to reduce the value of current peaks $< 70 \times I_n$.

Operating conditions: Capacitor switching contactors are protected against welding for a prospective peak inrush current of $200 \times I_n$.

Capacitor switching contactors K3-..A can exclusively be used for switching capacitors with harmonic filter reactors.

Other coil voltages on request

Auxiliary Contact Blocks

Article- No.	Type	Rated operational current			For contactors	Contacts		Weight approx. [kg/pc.]
		AC15 230 V [A]	400 V [A]	AC1 690 V [A]				
89-00294	HB11	3	2	10	K3-24... to K3-115...	1	1	0.02
89-00281	HN10	3	2	10	K3-18... to K3-115...	1	-	0.02

Components

Capacitor Switching Contactors for Power Factor Correction Systems with or without reactors

1

Dimensions

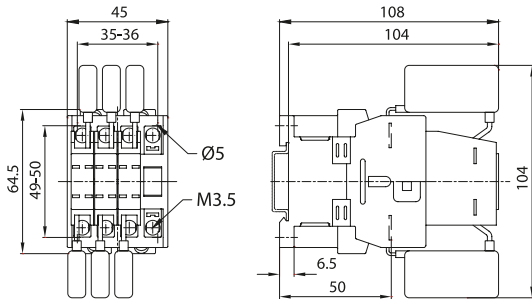

Dimensional drawing K3-18NBK

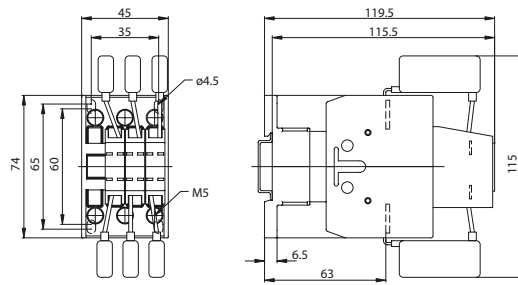

Dimensional drawing K3-24K00, K3-32K00

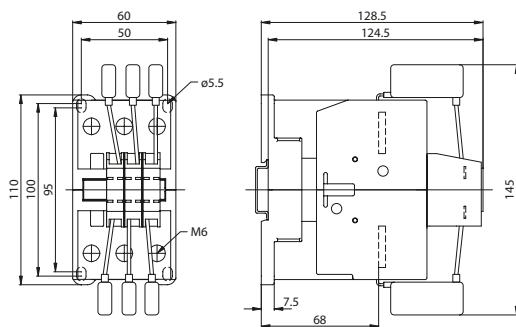

Dimensional drawing K3-50K00, K3-62K00, K3-74K00

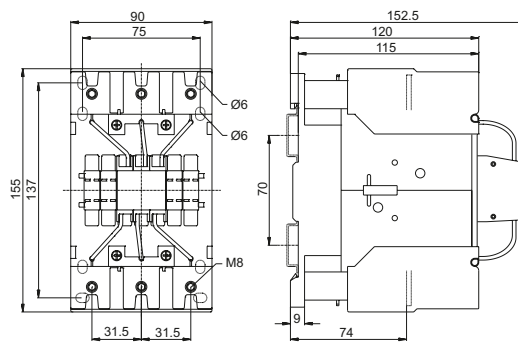

Dimensional drawing K3-90K00, K3-115K00

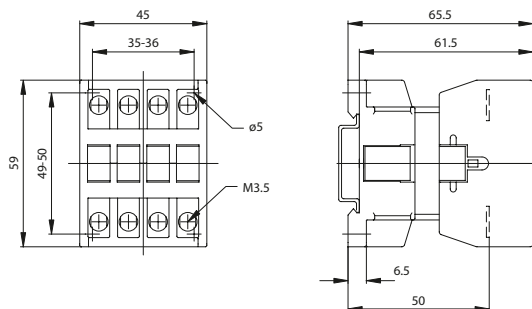

Dimensional drawing K3-18ND10

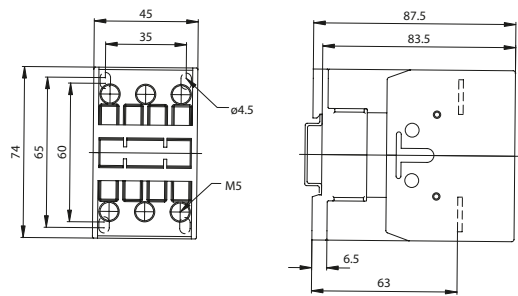

Dimensional drawing K3-24A00, K3-32A00

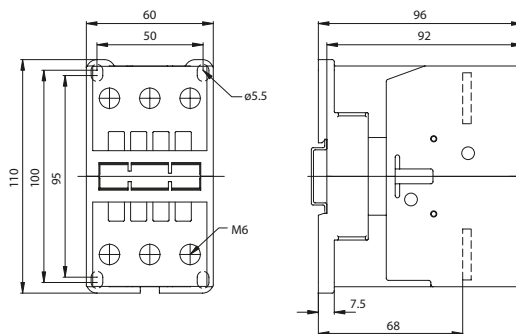

Dimensional drawing K3-50A00, K3-62A00, K3-74A00

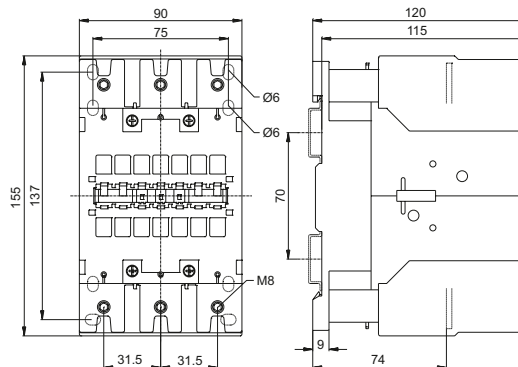

Dimensional drawing K3-90A00, K3-115A00

All dimensions in mm

Components

Discharge Reactors



FR 3AC Discharge Reactors

**Fast and secure discharging of Power Capacitors
with low-loss Discharge Reactors.**

- Fast discharging of capacitors steps
(< 5 seconds at 50 kvar / 400 V)
- 230 to 690 V rated operating voltage
- Three-phase design

Application Recommendations

Due to the integrated discharge resistors FRAKO Power Factor Correction Capacitors discharge within approx. 1 minute. The reconnection of a capacitor stage will be delayed due to the time a capacitor needs for discharging.

Some applications require a fast reconnection. Therefore, the time a capacitor needs to discharge has to be reduced. Discharge reactors safely discharge the capacitor within a few seconds.

Components

Discharge Reactors

Technical Data

	Discharge Reactor	
Type	FR3AC230-690V	FR3AC230-690V-G
Rated operating voltage	3AC 230 V – 690 V	3AC 230 V – 690 V
Frequency	50 – 60Hz	50 – 60Hz
Operating losses	< 5W	< 5W
No-load current	< 4.5 mA	< 4.5 mA
Inductance	70H	70H
Time of discharge	230 V: 25 kvar < 5 s. 50 kvar < 10 s. 400 V: 50 kvar < 5 s. 100 kvar < 10 s. 690 V: 100 kvar < 5 s.	230 V: 25 kvar < 5 s. 50 kvar < 10 s. 400 V: 50 kvar < 5 s. 100 kvar < 10 s. 690 V: 100 kvar < 5 s.
Permissible discharges	3 / min	3 / min
Temperature class	T40 / E	T40 / E
Ambient temperature	-25...+60 °C	-25...+60 °C
Protection class	IP00	IP40
Abutting cross section	0.75-2.5 mm ²	0.75-2.5 mm ²
Fixing torque	0.5 Nm	0.5 Nm
Total weight	0.5 kg	0.6 kg
Testing voltage	4 kV AC	4 kV AC
Standards	EN 61558-2-20	EN 61558-2-20
Dimensions in mm (W x H x D)	77 x 96 x 55	45 x 122 x 100
Mounting	Mounted directly on the module	Snap assembly on top hat rail
Article-No.	88-02013	88-02132

Dimensions

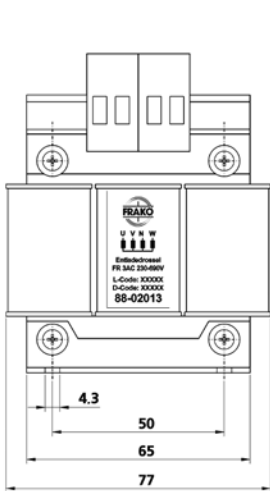

Dimensional drawing FR3AC230-690V

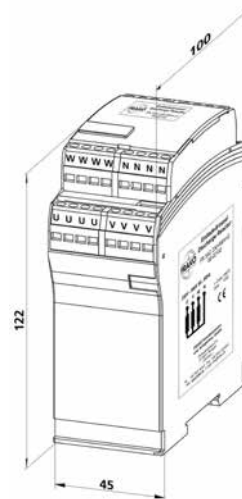
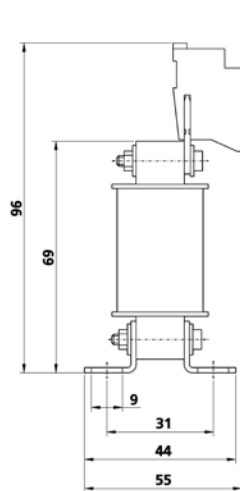

Dimensional drawing FR3AC230-690V-G

All dimensions in mm

Components

Discharge Reactors



PFC Capacitors in sheet steel cases

2

Power Factor Correction Capacitors in sheet steel cases

Page 53

Power Factor Correction Capacitors in sheet steel cases – detuned

Page 59

PFC Capacitors in sheet steel cases

Power Factor Correction Capacitors in sheet steel cases



2

Power Factor Correction Capacitors in sheet steel cases

Power Capacitors type LKN and LKSLT for fixed compensation of, for example, motors and transformers.

	LKN	LKSLT
		
Sheet steel case	•	•
With terminal block	•	
Ingress protection IP54	•	
With fuse switch		•
Ingress protection IP 20		•
Catalogue page	Page 55 ff.	Page 55 ff.

PFC Capacitors in sheet steel cases

Power Factor Correction Capacitors in sheet steel cases

2



PFC Capacitors in sheet steel cases

Power Factor Correction Capacitors in sheet steel cases



2

LKN / LKSLT

Power Factor Correction Capacitors in sheet steel cases

Power Capacitors type LKN and LKSLT for fixed compensation of, for example, motors and transformers.

- Power range: 7.5 to 100 kvar per case
- Ready for connection
- For floor installation or wall mounting
- Power Factor Correction Capacitors LKT dry-type with four safety features

Application Recommendations

Power Factor Correction Capacitors in sheet steel cases are mainly used for fixed compensation of motors and transformers. They are suitable for power factor correction in supply networks without harmonic distortion.

Attention: Even low harmonic levels can be amplified by network resonances. High harmonic levels can overload or damage all electrical devices and machines in the network.

Today, networks without harmonic distortion are quite rare. Therefore we generally recommend installing fixed capacitors with harmonic filter reactors (page 59 ff.).

PFC Capacitors in sheet steel cases

Power Factor Correction Capacitors in sheet steel cases

Power Range

Power Factor Correction Capacitors in sheet steel case:

- **LKN:** 7.5 to 100 kvar
- **LKSLT:** 7.5 to 60 kvar

Construction

Sheet steel case with plinth for floor mounting and lugs for wall mounting.

The case contains:

- Self-healing LKT type power capacitors with low loss self-healing dielectric made from segmented metallised polypropylene film. Filled with a PCB-free filler. With discharge resistors, as per EN 60831-1 and -2 as well as IEC 60831-1 and -2
- Fuse switch disconnecter size NH00 (only available for **LKSLT**)

Installation Site

The place of installation must comply with the requirements of the ingress protection and ambient temperature concerned.

Regulations

For installation and connection of Power Factor Correction Capacitors in Germany the following regulations must be complied with: VDE 0100, VDE 0105, VDE 0560 Part 46 and VDE 0106 Part 100 (German Association of Electrical Engineers). In other countries the equivalent local regulations must be followed.

Connection

The supply cable enters the cabinet through a cable gland and is connected to the studs on the junction plate (**LKN**). In case of an **LKSLT** it is directly connected at the fuse switch disconnecter.

Technical Data

Rated voltage	400 V/50 Hz
Rated voltage of capacitors	440 V/50 Hz
Ambient temperature	-10 °C to +45 °C
Humidity	Max. 90 %, no condensation
Case colour	RAL 7035
Standards	EN 60831-1 and -2 IEC 60831-1 and -2 EN 61921 IEC 61921 EN 61439-1 and -2 IEC 61439-1 and 2

Important Notes

The presence of inductive and capacitive reactances in the low voltage network means that the harmonics generated there, together with those fed in from the medium voltage network, can be amplified many times over due to resonance. Particularly in industrial networks with loads that generate harmonics, the use of conventional power factor correction systems without Harmonic Filter Reactors is not advisable. Instead, detuned systems should be installed. See the LKNS and LKND series of detuned power capacitors.

For further information on power factor correction and harmonics please refer to our "Manual of Power Factor Correction".

PFC Capacitors in sheet steel cases

Power Factor Correction Capacitors in sheet steel cases

Article- No.	Type	Rated power [kvar]	Rated capacity [μF]	Dimensions			Gland	Weight approx. [kg]	Protection IP
				Width [mm]	Height [mm]	Depth [mm]			

Power Factor Correction Capacitors in sheet steel cases, rated mains voltage: 400 V / 50 Hz

Type series: LKN

31-30075	LKN 7.5-400-D32	7.5	3 x 49.7	150	380	80	PG 16	5	54
31-30100	LKN 10-400-D32	10	3 x 66.3	150	380	80	PG 16	6	54
31-30125	LKN 12.5-400-D32	12.5	3 x 82.9	220	380	80	PG 29	6	54
31-30150	LKN 15-400-D32	15	3 x 99.5	220	380	80	PG 29	7	54
31-30200	LKN 20-400-D32	20	3 x 132.6	250	450	150	PG 36	10	54
31-30250	LKN 25-400-D32	25	3 x 165.8	250	450	150	PG 36	10	54
31-30300	LKN 30-400-D32	30	3 x 198.9	250	450	150	PG 36	11	54
31-30400	LKN 40-400-D32	40	3 x 265.3	410	450	150	PG 42	15	54
31-30500	LKN 50-400-D32	50	3 x 331.6	410	450	150	PG 42	15	54
31-30600	LKN 60-400-D32	60	3 x 397.9	410	450	150	PG 42	16	54
31-30603	LKN 75-400-D32	75	3 x 497.4	525	500	195	PG 42	22	54
31-30604	LKN 80-400-D32	80	3 x 530.5	525	500	195	PG 42	23	54
31-30606	LKN 85-400-D32	85	3 x 563.7	525	500	195	PG 42	23	54
31-30605	LKN 100-400-D32	100	3 x 663.2	525	500	195	PG 42	25	54

Power Factor Correction Capacitors in sheet steel cases, with switch disconnecter, rated mains voltage: 400 V / 50 Hz

Type series: LKSLT

31-21075	LKSLT 7.5-400-D30	7.5	3 x 49.7	410	410	184	PG 16	12	20
31-21100	LKSLT 10-400-D30	10	3 x 66.3	410	410	184	PG 16	15	20
31-21125	LKSLT 12.5-400-D30	12.5	3 x 82.9	410	410	184	PG 29	13	20
31-21150	LKSLT 15-400-D30	15	3 x 99.5	410	410	184	PG 29	15	20
31-21200	LKSLT 20-400-D30	20	3 x 132.6	410	410	184	PG 36	14	20
31-21250	LKSLT 25-400-D30	25	3 x 165.8	410	410	184	PG 36	16	20
31-21300	LKSLT 30-400-D30	30	3 x 198.9	410	410	184	PG 36	17	20
31-21400	LKSLT 40-400-D30	40	3 x 265.3	410	410	184	PG 42	17	20
31-21500	LKSLT 50-400-D30	50	3 x 331.6	560	410	184	PG 42	18	20
31-21761	LKSLT 55-400-D30	55	3 x 364.7	560	410	184	PG 42	20	20
31-21600	LKSLT 60-400-D30	60	3 x 397.9	560	410	184	PG 42	20	20

Other rated voltages, frequencies and power ratings on request.

Recommended supply lead cross sections: please refer to the technical annex (page 137 ff.).

PFC Capacitors in sheet steel cases

Power Factor Correction Capacitors in sheet steel cases

Dimensions

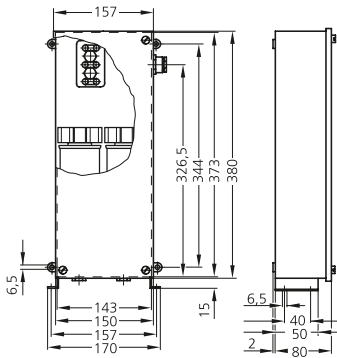

Dimensional drawing LKN
Case type 1
(7.5 to 10 kvar)

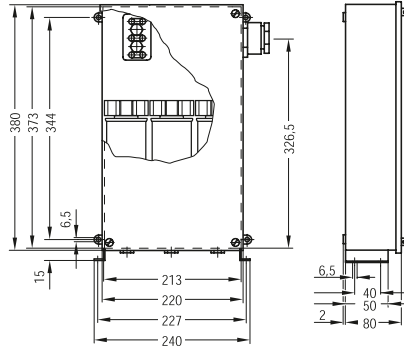

Dimensional drawing LKN
Case type 2
(12.5 to 15 kvar)

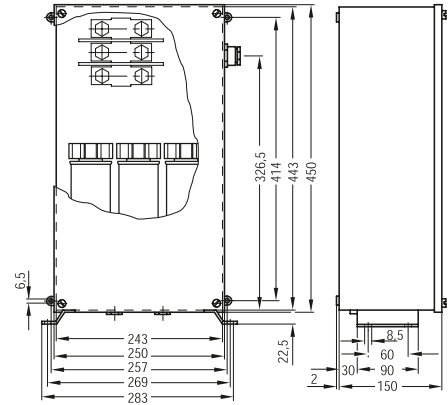

Dimensional drawing LKN
Case type 3
(20 to 30 kvar)

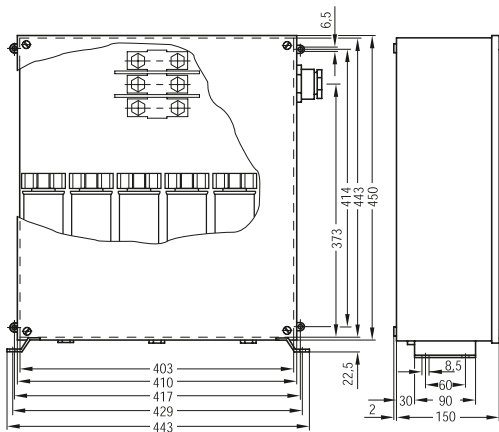

Dimensional drawing LKN
Case type 4
(40 to 60 kvar)

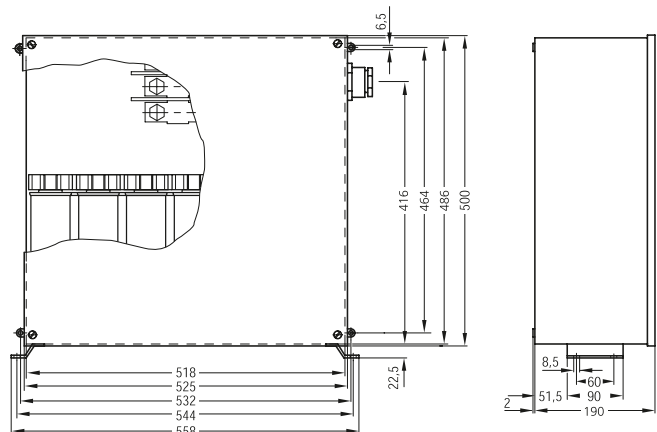

Dimensional drawing LKN
Case type 5
(75 to 100 kvar)

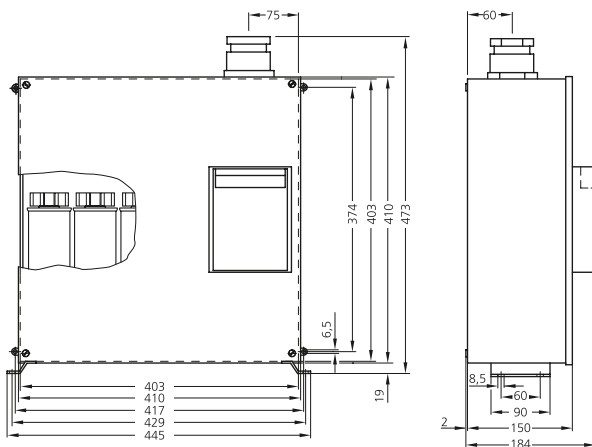

Dimensional drawing LKSLT
Case type 1 (7.5 to 40 kvar)

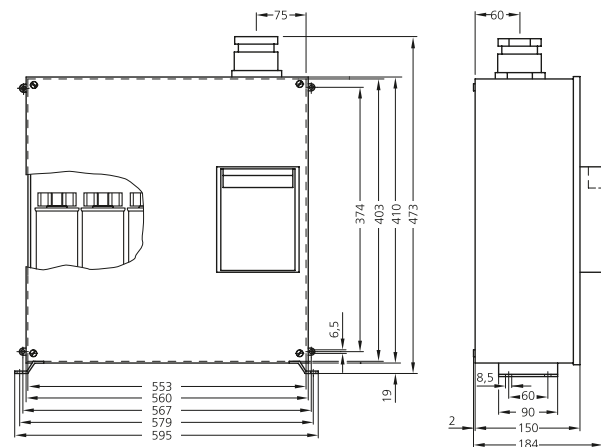

Dimensional drawing LKSLT
Case type 2 (50 to 60 kvar)

All dimensions in mm

PFC Capacitors in sheet steel cases

Power Factor Correction Capacitors in sheet steel cases – detuned



Power Factor Correction Capacitors in sheet steel cases – detuned

Power Capacitors type LKND-P and LKNS-P for fixed compensation of inductive consumers in networks with high harmonic content.

	LKND-P...	LKNS-P...
		
Sheet steel case	•	•
With capacitor switching contactors		•
Ingress protection IP20	•	•
Additional fuse switch (optional)	•	•
Catalogue page	Page 61	Page 61

PFC Capacitors in sheet steel cases

Power Factor Correction Capacitors in sheet steel cases – detuned

2



PFC Capacitors in sheet steel cases

Power Factor Correction Capacitors in sheet steel cases – detuned



2

LKND-P / LKNS-P

Power Factor Correction Capacitors in sheet steel cases – detuned

Power Capacitors type LKND-P and LKNS-P for fixed compensation of inductive consumers in networks with high harmonic content.

- Power Range: 7.5 to 50 kvar per case
- Ready for connection
- Power Factor Correction Capacitors LKT dry-type with four safety features
- Low-loss harmonic filter reactors, type: Standard

Application Recommendations

Detuned Power Factor Correction Capacitors in sheet steel cases are mainly used for fixed compensation of motors and transformers.

They are suitable for compensation in supply networks with harmonic distortion according to EN 61000-2-4 class 2.

They are available as follows:

Version	Detuning factor	Resonance frequency
P1	$\rho = 14 \%$	134 Hz
P7	$\rho = 7 \%$	189 Hz
P8	$\rho = 8 \%$	177 Hz

PFC Capacitors in sheet steel cases

Power Factor Correction Capacitors in sheet steel cases – detuned

Power Range

Power Factor Correction Capacitors in sheet steel case - detuned:

- **LKND-P:** 6.25 to 50 kvar
- **LKNS-P:** 10 to 50 kvar

Construction

Sheet steel case suitable for wall mounting or as freestanding cabinet (with socket, see accessories / options).

The case contains:

- Self-healing LKT type power capacitors with low loss self-healing dielectric made from segmented metallised polypropylene film. Filled with a PCB-free filler. With discharge resistors, as per EN 60831-1 and -2 as well as IEC 60831-1 and -2
- Low-loss harmonic filter reactors with thermal trip switch

The LKNS series furthermore contains:

- Capacitor switching contactors
- Control terminal strip with control fuse
- Control switch indicator light

Natural air cooling is ensured by appropriate cutouts in the door and on the roof.

Regulations

For installation and connection of Power Factor Correction Capacitors in Germany the following regulations must be complied with: VDE 0100, VDE 0105, VDE 0560 Part 46 and VDE 0106 Part 100 (German Association of Electrical Engineers). In other countries the equivalent local regulations must be followed.

Installation Site

The place of installation must comply with the requirements of the ingress protection and ambient temperature concerned.

Connection

The supply cable enters the cabinet from below and is connected to the studs of the junction plate.

Technical Data

Rated voltage	400 V/50 Hz
Rated voltage of capacitors	440 V/50 Hz
Ambient temperature	-10 °C to +40 °C
Humidity	Max. 90 %, no condensation
Case colour	RAL 7035
Standards	EN 60831-1 and -2 IEC 60831-1 and -2 EN 61921 IEC 61921 EN 61439-1 and -2 IEC 61439-1 and 2

Important Notes

For further information on power factor correction and harmonics please refer to our "Manual of Power Factor Correction".

PFC Capacitors in sheet steel cases

Power Factor Correction Capacitors in sheet steel cases – detuned

Type: LKND-P

Article-No.	Type	Rated power [kvar]	Rated capacity [μF]	Dimensions			Weight approx. [kg]	Protection IP
				Width [mm]	Height [mm]	Depth [mm]		

Power Factor Correction Capacitors in sheet steel cases, detuned, rated mains voltage 400 V / 50 Hz

Type series: LKND ...-P1 (Detuning factor p = 14 %)

31-22097	LKND 6,25-400-2-P1	6.25	3 x 41.5	600	850	275	48	20
31-22010	LKND 10-400-2-P1	10	3 x 66.3	600	850	275	52	20
31-22011	LKND 12,5-400-2-P1	12.5	3 x 82.9	600	850	275	55	20
31-22012	LKND 15-400-2-P1	15	3 x 99.5	600	850	275	57	20
31-22013	LKND 20-400-2-P1	20	3 x 132.6	600	850	275	63	20
31-22014	LKND 25-400-2-P1	25	3 x 165.8	600	850	275	70	20
31-22015	LKND 30-400-2-P1	30	3 x 198.9	600	850	275	74	20
31-22016	LKND 40-400-2-P1	40	3 x 265.3	600	850	275	89	20
31-22017	LKND 50-400-2-P1	50	3 x 331.6	600	850	275	94	20

Power Factor Correction Capacitors in sheet steel cases, detuned, rated mains voltage 400 V / 50 Hz

Type series: LKND ...-P7 (Detuning factor p = 7 %)

31-22018	LKND 7,5-400-2-P7	7.5	3 x 49.7	600	850	275	48	20
31-22019	LKND 10-400-2-P7	10	3 x 66.3	600	850	275	49	20
31-22020	LKND 12,5-400-2-P7	12.5	3 x 82.9	600	850	275	49	20
31-22021	LKND 15-400-2-P7	15	3 x 99.5	600	850	275	54	20
31-22022	LKND 20-400-2-P7	20	3 x 132.6	600	850	275	54	20
31-22023	LKND 25-400-2-P7	25	3 x 165.8	600	850	275	57	20
31-22009	LKND 30-400-2-P7	30	3 x 198.9	600	850	275	63	20
31-22025	LKND 40-400-2-P7	40	3 x 265.3	600	850	275	65	20
31-22026	LKND 50-400-2-P7	50	3 x 331.6	600	850	275	72	20

Power Factor Correction Capacitors in sheet steel cases, detuned, rated mains voltage 400 V / 50 Hz

Type series: LKND ...-P8 (Detuning factor p = 8 %)

31-22035	LKND 7,5-400-2-P8	7.5	3 x 49.7	600	850	275	49	20
31-22072	LKND 10-400-2-P8	10	3 x 66.3	600	850	275	50	20
31-22102	LKND 12,5-400-2-P8	12.5	3 x 82.9	600	850	275	51	20
31-22071	LKND 15-400-2-P8	15	3 x 99.5	600	850	275	56	20
31-22080	LKND 20-400-2-P8	20	3 x 132.6	600	850	275	56	20
31-22081	LKND 25-400-2-P8	25	3 x 165.8	600	850	275	62	20
31-22046	LKND 30-400-2-P8	30	3 x 198.9	600	850	275	61	20
31-22086	LKND 40-400-2-P8	40	3 x 265.3	600	850	275	65	20
31-22063	LKND 50-400-2-P8	50	3 x 331.6	600	850	275	72	20

Other rated voltages, frequencies and power ratings on request.

Recommended supply lead cross sections: please refer to the technical annex (page 137 ff.).

Accessories

Article-No.	Type	Description
34-80196	KR-LSK-2/LKND/LKNS-200	base 200 mm (needed for floor installation)

PFC Capacitors in sheet steel cases

Power Factor Correction Capacitors in sheet steel cases – detuned

Type: LKNS-P

Article-No.	Type	Rated power [kvar]	Rated capacity [μF]	Dimensions			Weight approx. [kg]	Protection IP
				Width [mm]	Height [mm]	Depth [mm]		

Power Factor Correction Capacitors in sheet steel cases, detuned, rated mains voltage 400 V / 50 Hz

Type series: LKNS ...-P1 (Detuning factor p = 14 %)

31-21105	LKNS 10-400-2-P1	10	3 x 66.3	600	850	275	54	20
31-21133	LKNS 12,5-400-2-P1	12.5	3 x 82.9	600	850	275	61	20
31-21155	LKNS 15-400-2-P1	15	3 x 99.5	600	850	275	63	20
31-21212	LKNS 20-400-2-P1	20	3 x 132.6	600	850	275	65	20
31-21260	LKNS 25-400-2-P1	25	3 x 165.8	600	850	275	60	20
31-21311	LKNS 30-400-2-P1	30	3 x 198.9	600	850	275	74	20
31-21404	LKNS 40-400-2-P1	40	3 x 256.3	600	850	275	94	20
31-21505	LKNS 50-400-2-P1	50	3 x 331.6	600	850	275	98	20

Power Factor Correction Capacitors in sheet steel cases, detuned, rated mains voltage 400 V / 50 Hz

Type series: LKNS ...-P7 (Detuning factor p = 7 %)

31-21106	LKNS 10-400-2-P7	10	3 x 66.3	600	850	275	58	20
31-21127	LKNS 12,5-400-2-P7	12.5	3 x 82.9	600	850	275	58	20
31-21153	LKNS 15-400-2-P7	15	3 x 99.5	600	850	275	59	20
31-21211	LKNS 20-400-2-P7	20	3 x 132.6	600	850	275	60	20
31-21257	LKNS 25-400-2-P7	25	3 x 165.8	600	800	275	62	20
31-21309	LKNS 30-400-2-P7	30	3 x 198.9	600	850	275	64	20
31-21403	LKNS 40-400-2-P7	40	3 x 256.3	600	850	275	68	20
31-21503	LKNS 50-400-2-P7	50	3 x 331.6	600	850	275	72	20

Power Factor Correction Capacitors in sheet steel cases, detuned, rated mains voltage 400 V / 50 Hz

Type series: LKNS ...-P8 (Detuning factor p = 8 %)

31-21110	LKNS 10-400-2-P8	10	3 x 66.3	600	850	275	59	20
31-21126	LKNS 12,5-400-2-P8	12.5	3 x 82.9	600	850	275	59	20
31-21154	LKNS 15-400-2-P8	15	3 x 99.5	600	850	275	60	20
31-21216	LKNS 20-400-2-P8	20	3 x 132.6	600	850	275	61	20
31-21261	LKNS 25-400-2-P8	25	3 x 165.8	600	850	275	63	20
31-21312	LKNS 30-400-2-P8	30	3 x 198.9	600	850	275	65	20
31-21406	LKNS 40-400-2-P8	40	3 x 256.3	600	850	275	69	20
31-21504	LKNS 50-400-2-P8	50	3 x 331.6	600	850	275	63	20

Other rated voltages, frequencies and power ratings on request.

Recommended supply lead cross sections: please refer to the technical annex (page 137 ff.).

Accessories

Article-No.	Type	Description
34-80196	KR-LSK-2/LKND/LKNS-200	base 200 mm (needed for floor installation)

PFC Capacitors in sheet steel cases

Power Factor Correction Capacitors in sheet steel cases – detuned

Dimensions

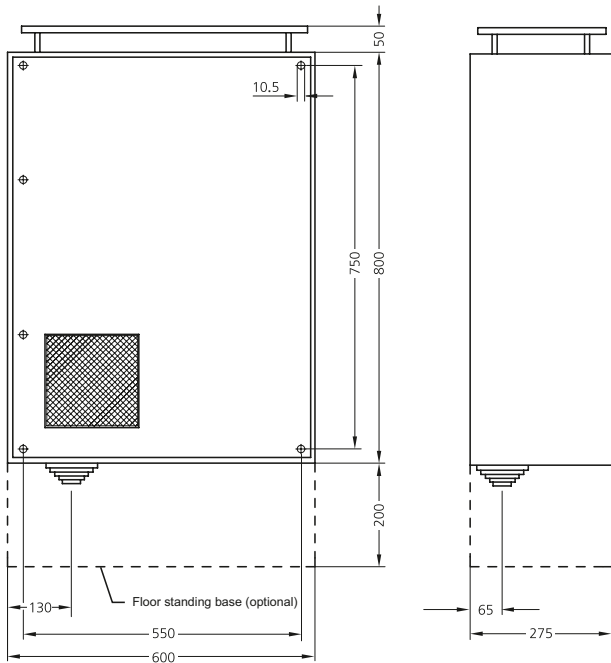

Dimensional drawing LKND-P (6.25 to 50 kvar)

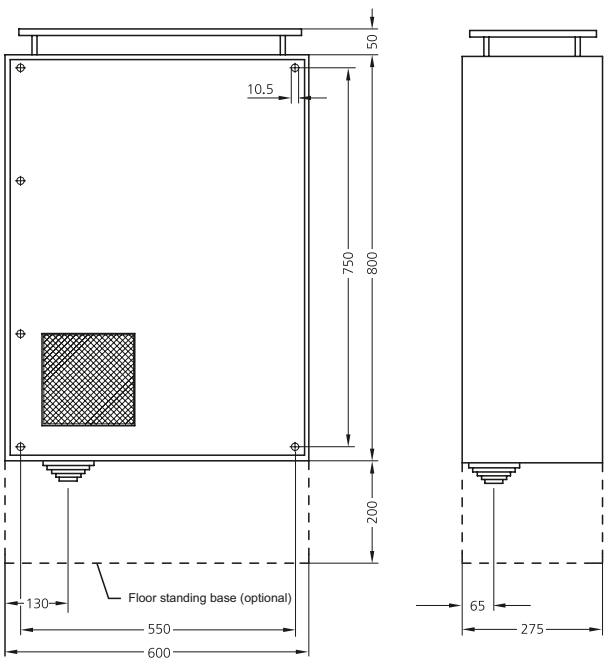

Dimensional drawing LKNS-P (10 to 50 kvar)

All dimensions in mm

PFC Systems on mounting plates / Capacitor Modules

Power Factor Correction Systems on mounting plates

Page 67

Power Factor Correction Systems on mounting plates – detuned

Page 73

Capacitor Modules

Page 77

Capacitor Modules – detuned

Page 81

PFC Systems on mounting plates / Capacitor Modules

Power Factor Correction Systems on mounting plates



3

Power Factor Correction Systems on mounting plates

PFC Systems on mounting plates for installation in standard switchboards. Type LSPN is also suitable for installation in DIN standard distribution boards.

	LSPN	LSP...-2...	LSP...-3...
			
Power range	17.5-60 kvar	68.75-100 kvar	112.5-200 kvar
Used for cabinets size (500 x 500 x 300 mm)	•		
Used for cabinets size (600 x 800 x 275 mm)		•	
Used for cabinets size (600 x 1200 x 300 mm)			•
Catalogue page	Page 69 ff.	Page 69 ff.	Page 69 ff.

PFC Systems on mounting plates / Capacitor Modules

Power Factor Correction Systems on mounting plates

3



PFC Systems on mounting plates / Capacitor Modules

Power Factor Correction Systems on mounting plates



3

LSPN / LSP

Power Factor Correction Systems on mounting plates

**PFC System on mounting plates for installation in standard switchboards.
Type LSPN is also suitable for installation in DIN standard distribution boards.**

- Power Range: 17.5 to 200 kvar
- Compact design on a mounting plate
- Ready for connection (without control relay and relay cable)
- Power Factor Correction Capacitors LKT dry-type with four safety features

Application Recommendations

Power Factor Correction Systems on mounting plates type LSPN / LSP are suitable for installation in standard switchboards. Type LSPN is also suitable for installation in DIN standard distribution boards. Those systems are pre-wired. One only has to connect the Power Factor Correction Relay (not included) with the terminal strip. Those systems are suitable for power factor correction in networks without harmonic distortion.

Attention: Even low harmonic levels can be amplified by network resonances. High harmonic levels can overload or damage all electrical devices and machines in the network.

Today, networks without harmonic distortion are quite rare. Therefore we generally recommend installing fixed capacitors with Harmonic Filter Reactors (page 73 ff).

PFC Systems on mounting plates / Capacitor Modules

Power Factor Correction Systems on mounting plates

Power Range

Power Factor Correction System on mounting plate:

- **LSPN -4:** 17.5 to 60 kvar
- **LSP -2:** 68.75 to 100 kvar
- **LSP -3:** 112.5 to 200 kvar

Construction

Mounting plate with mounted Power Factor Correction Capacitors. Capacitor Switching Contactors and fuses for installation in switchboards.

The system contains:

- Self-healing LKT type power capacitors with low-loss self-healing dielectric made from segmented metallised polypropylene film. Filled with a PCB-free filler. With discharge resistors, as per EN 60831-1 and -2 as well as IEC 60831-1 and -2
- Capacitor Switching Contactors with leading transition contact for damping of current peaks
- Fuse links, 3-pole, size NH00
- Control terminal strip with control fuse and thermal trip switch

Regulations

For installation and connection of Power Factor Correction Capacitors in Germany the following regulations must be complied with: VDE 0100, VDE 0105, VDE 0560 Part 46 and VDE 0106 Part 100 (German Association of Electrical Engineers). In other countries the equivalent local regulations must be followed.

Installation Site

The place of installation must comply with the requirements of the ingress protection and ambient temperature concerned.

Connection

The power cable is connected to the LV NH00 fuse element; The Power Factor Correction Relay (not included) as well as the cable from the current transformer has to be connected to the control terminal strip.

System Expansion

An extension of the system is possible by adding LSPZ extension units. This extension unit will be integrated in the existing control circuit via the control cable (supplied with the extension unit).

Technical Data

Rated voltage	400 V/50 Hz
Rated voltage of capacitors	440 V/50 Hz
Ambient temperature	-5 °C to +60 °C
Humidity	Max. 90 %, no condensation
Standards	EN 60831-1 and -2 IEC 60831-1 and -2 EN 61921 IEC 61921 EN 61439-1 and -2 IEC 61439-1 and 2

Important Notes

The presence of inductive and capacitive reactances in the low voltage network means that the harmonics generated there, together with those fed in from the medium voltage network, can be amplified many times over due to resonance. Particularly in industrial networks with loads that generate harmonics, the use of conventional power factor correction systems without Harmonic Filter Reactors is not advisable. Instead, detuned systems should be installed. See the LSP-P series of Power Factor Correction Systems on mounting plates.

For further information on power factor correction and harmonics please refer to our "Manual of Power Factor Correction".

PFC Systems on mounting plates / Capacitor Modules

Power Factor Correction Systems on mounting plates

Article- No.	Type	Rated power [kvar]	Step power [kvar]	Switching sequence	Dimensions			Weight (gross) approx. [kg]	Protection IP
					Width [mm]	Height [mm]	Depth [mm]		

Power Factor Correction Systems on mounting plates, rated mains voltage: 400 V / 50 Hz

Type series: LSPN ...-4

34-57530	LSPN 17,5-2,5-111-400/440-4	17.5	2.5	1:2:4	450	450	260	13	00
34-57531	LSPN 27,5-2,5-112-400/440-4	27.5	2.5	1:2:4:4	450	450	260	14	00
34-57532	LSPN 30-5-11A-400/440-4	30	5	1:2:3	450	450	260	14	00
34-57533	LSPN 37,5-2,5-1111-400/440-4	37.5	2.5	1:2:4:8	450	450	260	16	00
34-57534	LSPN 37,5-7,5-12-400/480-4	37.5	7.5	1:2:2	450	450	260	15	00
34-57535	LSPN 43,75-6,25-111-400/440-4	43.75	6.25	1:2:4	450	450	260	15	00
34-57536	LSPN 46,88-3,13-1111-400/440-4	46.88	3.13	1:2:4:8	450	450	260	16	00
34-57537	LSPN 50-5-11A1-400/440-4	50	5	1:2:3:4	450	450	260	17	00
34-57538	LSPN 50-10-12-400/440-4	50	10	1:2:2	450	450	260	16	00
34-57539	LSPN 52,5-7,5-111-400/440-4	52.5	7.5	1:2:4	450	450	260	17	00
34-57540	LSPN 60-10-11A-400/440-4	60	10	1:2:3	450	450	260	18	00

Power Factor Correction Systems on mounting plates, rated mains voltage: 400 V / 50 Hz

Type series: LSP ...-2

34-57051	LSP 68,75-6,25-112-400/440-2	68.75	6.25	1:2:4:4	550	567.5	235	23	00
34-57052	LSP 75-6,25-212-400/440-2	75	6.25	1:1:2:4:4	550	567.5	235	25	00
34-57088	LSP 75-12,5-11A-400/440-2	75	12.5	1:2:3	550	567.5	235	24	00
34-57053	LSP 75-12,5-22-400/440-2	75	12.5	1:1:2:2	550	567.5	235	24	00
34-57054	LSP 87,5-12,5-111-400/440-2	87.5	12.5	1:2:4	550	567.5	235	25	00
34-57055	LSP 93,75-6,25-1111-400/440-2	93.75	6.25	1:2:4:8	550	567.5	235	25	00
34-57056	LSP 100-12,5-211-400/440-2	100	12.5	1:1:2:4	550	567.5	235	26	00

Power Factor Correction Systems, extension units on mounting plates, rated mains voltage: 400 V / 50 Hz

Type series: LSPZ ...-2

34-57100	LSPZ 50-50-1-400/440-2	50	50	1	550	567.5	235	18	00
34-57101	LSPZ 75-25-11-400/440-2	75	25	1:2	550	567.5	235	23	00
34-57102	LSPZ 100-50-2-400/440-2	100	50	1:1	550	567.5	235	25	00

Power Factor Correction Systems on mounting plates, rated mains voltage: 400 V / 50 Hz

Type series: LSP ...-3

34-57060	LSP 112,5-6,25-11AB-400/440-3	112.5	6.25	1:2:3:6:6	550	1157	240	55	00
34-57061	LSP 125-12,5-221-400/440-3	125	12.5	1:1:2:2:4	550	1157	240	55	00
34-57062	LSP 143,75-6,25-1112-400/440-3	143.75	6.25	1:2:4:8:8	550	1157	240	57	00
34-57063	LSP 150-12,5-212-400/440-3	150	12.5	1:1:2:4:4	550	1157	240	56	00
34-57064	LSP 150-25-22-400/440-3	150	25	1:1:2:2	550	1157	240	58	00
34-57065	LSP 175-25-13-400/440-3	175	25	1:2:2:2	550	1157	240	60	00
34-57066	LSP 187,5-12,5-113-400/440-3	187.5	12.5	1:2:4:4:4	550	1157	240	61	00
34-57067	LSP 200-12,5-213-400/440-3	200	12.5	1:1:2:4:4:4	550	1157	240	64	00
34-57068	LSP 200-25-23-400/440-3	200	25	1:1:2:2:2	550	1157	240	64	00

Power Factor Correction Systems, extension units on mounting plates, rated mains voltage: 400 V / 50 Hz

Type series: LSPZ ...-3

34-57103	LSPZ 150-50-3-400/440-3	150	50	1:1:1	550	1157	240	59	00
34-57104	LSPZ 200-50-4-400/440-3	200	50	1:1:1:1	550	1157	240	67	00

Other rated voltages, frequencies and power ratings on request.

Recommended supply lead cross sections: please refer to the technical annex (page 137 ff.).

For options and accessory equipment for PFC Systems on mounting plates, module rails, ordering examples and dimensional drawings see page 87 ff.

PFC Systems on mounting plates / Capacitor Modules

Power Factor Correction Systems on mounting plates

3



PFC Systems on mounting plates / Capacitor Modules

Power Factor Correction Systems on mounting plates – detuned



3

LSP-P

Power Factor Correction Systems on mounting plates – detuned

Detuned PFC Systems on mounting plates for installation in standard switchboards for low-voltage networks with harmonic content.

- Power range: 17.5 to 100 kvar
- Compact design on a mounting plate
- Ready for connection (without control relay and relay cable)
- Power Factor Correction Capacitors LKT dry-type with four safety features

Application Recommendations

Power Factor Correction Systems on mounting plates type LSP-P are suitable for installation in standard switchboards. Those systems are pre-wired. One only has to connect the Power Factor Correction Relay (not included) to the terminal strip.

They are suitable for supply networks with harmonic distortion according to EN 61000-2-4 class 2. They are available as follows:

Version	Detuning factor	Resonance frequency
P1	$\rho = 14 \%$	134 Hz
P7	$\rho = 7 \%$	189 Hz
P8	$\rho = 8 \%$	177 Hz

PFC Systems on mounting plates / Capacitor Modules

Power Factor Correction Systems on mounting plates – detuned

Power Range

Power Factor Correction System on mounting plate - detuned:

- 17.5 to 100 kvar

Construction

Mounting plate with mounted Power Factor Correction Capacitors, Capacitor Switching Contactors and fuses for installation in switchboards.

The system contains:

- Self-healing LKT type power capacitors with low loss self-healing dielectric made from segmented metallised polypropylene film. Filled with a PCB-free filler. With discharge resistors, as per EN 60831-1 and -2 as well as IEC 60831-1 and -2
- Heavy duty Capacitor Switching Contactors
- Harmonic Filter Reactors with overtemperature switch
- Fuse links, 3-pole, size NH00
- Control terminal strip with control fuse and thermal contact for safety shutdown

Installation Site

The place of installation must comply with the requirements of the ingress protection and ambient temperature concerned.

Regulations

For installation and connection of Power Factor Correction Capacitors in Germany the following regulations must be complied with: VDE 0100, VDE 0105, VDE 0560 Part 46 and VDE 0106 Part 100 (German Association of Electrical Engineers). In other countries the equivalent local regulations must be followed.

Connection

The power cable is connected to the LV NH00 fuse element; The Power Factor Correction Relay (not included) as well as the cable from the current transformer has to be connected to the control terminal strip.

System Expansion

An extension of the system is possible by adding LSPZ-P extension units. This extension unit will be integrated in the existing control circuit via the control cable (supplied with the extension unit).

Technical Data

Rated voltage	400 V/50 Hz
Rated voltage of capacitors	440 V/50 Hz (-P7 and -P8) 480 V/50 Hz (-P1)
Ambient temperature	-5 °C to +60 °C
Humidity	Max. 90 %, no condensation
Standards	EN 60831-1 and -2 IEC 60831-1 and -2 EN 61921 IEC 61921 EN 61439-1 and -2 IEC 61439-1 and 2

Important Notes

For further information on power factor correction and harmonics please refer to our "Manual of Power Factor Correction".

PFC Systems on mounting plates / Capacitor Modules

Power Factor Correction Systems on mounting plates – detuned

Version: P1 (Detuning factor $p = 14\%$)

Article- No.	Type	Rated power [kvar]	Step power [kvar]	Switching sequence	Dimensions			Weight (gross) approx. [kg]	Protection IP
					Width [mm]	Height [mm]	Depth [mm]		

Power Factor Correction Systems on mounting plates, rated mains voltage: 400 V / 50 Hz

Type series: LSP ...-3-P1

34-57701	LSP 25-6,25-21-400/480-3-P1	25	6.25	1:1:2	550	1157	240	69	00
34-57702	LSP 31,25-6,25-12-400/480-3-P1	31.25	6.25	1:2:2	550	1157	240	75	00
34-57703	LSP 43,75-6,25-111-400/480-3- P1	43.75	6.25	1:2:4	550	1157	240	84	00
34-57704	LSP 50-6,25-211-400/480-3-P1	50	6.25	1:1:2:4	550	1157	240	98	00
34-57705	LSP 50-12,5-21-400/480-3-P1	50	12.5	1:1:2	550	1157	240	90	00
34-57707	LSP 62,5-12,5-12-400/480-3-P1	62.5	12.5	1:2:2	550	1157	240	105	00
34-57708	LSP 68,75-6,25-112-400/480-3- P1	68.75	6.25	1:2:4:4	550	1157	240	115	00
34-57709	LSP 75-12,5-22-400/480-3-P1	75	12.5	1:1:2:2	550	1157	240	120	00
34-57852	LSP 75-12,5-11A-400/480-3-P1	75	12.5	1:2:3	550	1157	240	123	00
34-57710	LSP 75-25-11-400/480-3-P1	75	25	1:2	550	1157	240	121	00
34-57711	LSP 87,5-12,5-111-400/480-3-P1	87.5	12.5	1:2:4	550	1157	240	126	00
34-57781	LSP 100-16,67-11A-400/480-3-P1	100	16.67	1:2:3	550	1157	240	143	00

Power Factor Correction Systems, extension units on mounting plates, rated mains voltage: 400 V / 50 Hz

Type series: LSPZ ...-3-P1

34-57900	LSPZ 50-50-1-400/480-3-P1	50	50	1	550	1157	240	83	00
34-57901	LSPZ 75-25-11-400/440-3-P1	75	25	1:2	550	1157	240	87	00

Other rated voltages, frequencies and power ratings on request.

Recommended supply lead cross sections: please refer to the technical annex (page 137 ff.).

PFC Systems on mounting plates / Capacitor Modules

Power Factor Correction Systems on mounting plates – detuned

Version: P7 (Detuning factor $p = 7\%$)

Article- No.	Type	Rated power [kvar]	Step power [kvar]	Switching sequence	Dimensions			Weight (gross) approx. [kg]	Protection IP
					Width [mm]	Height [mm]	Depth [mm]		

Power Factor Correction Systems on mounting plates, rated mains voltage: 400 V / 50 Hz

Type series: LSP ...-3-P7

34-57712	LSP 17,5-2,5-111-400/440-3-P7	17.5	2.5	1:2:4	550	1157	240	51	00
34-57713	LSP 25-5-12-400/440-3-P7	25	5	1:2:2	550	1157	240	57	00
34-57714	LSP 25-6,25-21-400/440-3-P7	25	6.25	1:1:2	550	1157	240	54	00
34-57715	LSP 30-5-11A-400/440-3-P7	30	5	1:2:3	550	1157	240	61	00
34-57716	LSP 31,25-6,25-12-400/440-3-P7	31.25	6.25	1:2:2	550	1157	240	59	00
34-57717	LSP 43,75-6,25-111-400/440-3-P7	43.75	6.25	1:2:4	550	1157	240	64	00
34-57718	LSP 50-6,25-211-400/440-3-P7	50	6.25	1:1:2:4	550	1157	240	72	00
34-57719	LSP 50-12,5-21-400/440-3-P7	50	12.5	1:1:2	550	1157	240	70	00
34-57721	LSP 52,5-7,5-111-400/440-3-P7	52.5	7.5	1:2:4	550	1157	240	79	00
34-57722	LSP 60-10-11A-400/440-3-P7	60	10	1:2:3	550	1157	240	79	00
34-57723	LSP 62,5-12,5-12-400/440-3-P7	62.5	12.5	1:2:2	550	1157	240	77	00
34-57724	LSP 68,75-6,25-112-400/440-3-P7	68.75	6.25	1:2:4:4	550	1157	240	82	00
34-57853	LSP 75-12,5-11A-400/440-3-P7	75	12.5	1:2:3	550	1157	240	88	00
34-57725	LSP 75-12,5-22-400/440-3-P7	75	12.5	1:1:2:2	550	1157	240	86	00
34-57726	LSP 75-25-11-400/440-3-P7	75	25	1:2	550	1157	240	87	00
34-57727	LSP 87,5-12,5-111-400/440-3-P7	87.5	12.5	1:2:4	550	1157	240	89	00
34-57728	LSP 93,75-6,25-1111-400/440-3-P7	93.75	6.25	1:2:4:8	550	1157	240	96	00
34-57729	LSP 100-12,5-211-400/440-3-P7	100	12.5	1:1:2:4	550	1157	240	102	00
34-57730	LSP 100-50-2-400/440-3-P7	100	50	1:1	550	1157	240	105	00
34-57780	LSP 100-16,67-11A-400/440-3-P7	100	16.67	1:2:3	550	1157	240	102	00
34-57768	LSP 100-25-21-400/440-3-P7	100	25	1:1:2	550	1157	240	104	00

Power Factor Correction Systems, extension units on mounting plates, rated mains voltage: 400 V / 50 Hz

Type series: LSPZ ...-3-P7

34-57902	LSPZ 50-50-1-400/440-3-P7	50	50	1	550	1157	240	65	20
34-57903	LSPZ 60-30-2-400/440-3-P7	60	30	1:1	550	1157	240	78	20
34-57904	LSPZ 75-25-11-400/440-3-P7	75	25	1:2	550	1157	240	102	20
34-57905	LSPZ 90-30-3-400/440-3-P7	90	30	1:1:1	550	1157	240	102	20
34-57906	LSPZ 100-50-2-400/440-3-P7	100	50	1:1	550	1157	240	99	20

Versions with an 8 % choke factor are available with the same corrective power and configuration of the capacitance stages.

Other rated voltages, frequencies and power ratings on request.

Recommended supply lead cross sections: please refer to the technical annex (page 137 ff.).



C64C / C84C Capacitor Modules

Capacitor Modules type C64C and C84C for installation in standard switchgear systems. Suitable for low-voltage networks without harmonic distortion.

- Power Range: 25 to 100 kvar per module
- Compact design; up to 5 modules per cabinet
- Ideal for mounting in all common switchgear systems
- Easy and quick mounting with multifunctional rails
- Power Factor Correction Capacitors LKT dry-type with four safety features

Application Recommendations

Capacitor modules type C64C and C84C are suitable for installation in standard switchgear systems. Additional mounting rails for all common switchgear systems:

- W = 600 mm, D = 400, 500, 600 mm resp.
- W = 800 mm, D = 400, 500, 600 mm

allow an easy and quick installation of complex Power Factor Correction Systems.

They are suitable for power factor correction in supply networks without harmonic distortion.

Attention: Even low harmonic levels can be amplified by network resonances. High harmonic levels can overload or damage all electrical devices and machines in the network.

Today, networks without harmonic distortion are quite rare. Therefore we generally recommend installing fixed capacitors with harmonic filter reactors (page 81 ff.).

PFC Systems on mounting plates / Capacitor Modules

Capacitor Modules

Power Range

Compact compensation module for installation in switchgear systems:

- 25 to 100 kvar

Construction

Sheet steel chassis with mounted power capacitors, contactors and fuses - ideal for mounting in all common switchgear systems.

The module consists of:

- Self-healing LKT type power capacitors with low loss self-healing dielectric made from segmented metallised polypropylene film. Filled with a PCB-free filler. With discharge resistors, as per EN 60831-1 and -2 as well as IEC 60831-1 and -2
- Capacitor Switching Contactors with leading transition contacts for damping of current peaks
- Busbar system with bus-mounting fuse bases, 3-pole, size NH00
- Control circuit with female connector (wired connector for connection with terminal strip incl.)

Application / Installation

The place of installation must comply with the requirements of the ingress protection and ambient temperature concerned.

Regulations

For installation and connection of Power Factor Correction Capacitors in Germany the following regulations must be complied with: VDE 0100, VDE 0105, VDE 0560 Part 46 and VDE 0106 Part 100 (German Association of Electrical Engineers). In other countries the equivalent local regulations must be followed.

Installation

Specific module rails are required for installation in the switchgear system. Those module rails are available for all common switchgear systems and can be supplied as an optional accessory.

Connection

The network connection can be done either vertically or horizontally. For the horizontal connection one has to connect the cables equipped with the cable lugs to the busbar by using the M12 screws.

A bus connection bracket CU AW-1 for vertical connection is available as an option.

Additional modules can be connected directly via the busbar system.

Technical Data

Design

Sheet steel chassis for installation in switchgear cabinets
C6xC... for cabinets (width = 600 mm)
C8xC... for cabinets (width = 800 mm)

Rated voltage 400 V/50 Hz

Rated voltage of capacitors 440 V/50 Hz

Ambient temperature -5 °C to +60 °C

Humidity Max. 90 %, no condensation

Standards EN 60831-1 and -2
IEC 60831-1 and -2
EN 61921
IEC 61921
EN 61439-1 and -2
IEC 61439-1 and 2

Important Notes

The presence of inductive and capacitive reactances in the low voltage network means that the harmonics generated there, together with those fed in from the medium voltage network, can be amplified many times over due to resonance. Particularly in industrial networks with loads that generate harmonics, the use of conventional power factor correction systems without Harmonic Filter Reactors is not advisable. Instead, detuned systems should be installed. See the C6xD... and C8xD... series of Capacitor Modules.

For further information on power factor correction and harmonics please refer to our "Manual of Power Factor Correction".

PFC Systems on mounting plates / Capacitor Modules

Capacitor Modules

Article- No.	Type	Rated power [kvar]	Step power [kvar]	Switching sequence	Dimensions			Weight (gross) approx. [kg]	Protection IP
					Width [mm]	Height [mm]	Depth [mm]		

Capacitor Modules for installation in switchgear systems with a width of 600 mm, rated mains voltage: 400 V / 50 Hz

Type series: C64C

34-64167	C64C 25-3,13-211-400/440-64	25	3.13	1:1:2:4	500	300	350	15	00
34-64163	C64C 25-6,25-21-400/440-64	25	6.25	1:1:2	500	300	350	15	00
34-64164	C64C 25-12,5-2-400/440-64	25	12.5	1:1	500	300	350	15	00
34-64165	C64C 25-25-1-400/440-64	25	25	1	500	300	350	16	00
34-64170	C64C 31,25-6,25-12-400/440-64	31.25	6.25	1:2:2	500	300	350	16	00
34-64180	C64C 34,38-3,13-112-400/440-64	34.38	3.13	1:2:4:4	500	300	350	16	00
34-64172	C64C 37,5-6,25-22-400/440-64	37.5	6.25	1:1:2:2	500	300	350	16	00
34-64173	C64C 37,5-12,5-11-400/440-64	37.5	12.5	1:2	500	300	350	16	00
34-64177	C64C 43,75-6,25-111-400/440-64	43.75	6.25	1:2:4	500	300	350	17	00
34-64181	C64C 46,88-3,13-1111-400/440-64	46.88	3.13	1:2:4:8	500	300	350	17	00
34-64288	C64C 50-3,13-2111-400/440-64	50	3.13	1:1:2:4:8	500	300	350	18	00
34-64182	C64C 50-6,25-211-400/440-64	50	6.25	1:1:2:4	500	300	350	18	00
34-64185	C64C 50-12,5-21-400/440-64	50	12.5	1:1:2	500	300	350	19	00
34-64186	C64C 50-25-2-400/440-64	50	25	1:1	500	300	350	19	00
34-64187	C64C 50-50-1-400/440-64	50	50	1	500	300	350	18	00
34-64193	C64C 62,5-12,5-12-400/440-64	62.5	12.5	1:2:2	500	300	350	19	00
34-64194	C64C 68,75-6,25-112-400/440-64	68.75	6.25	1:2:4:4	500	300	350	22	00
34-64196	C64C 75-12,5-22-400/440-64	75	12.5	1:1:2:2	500	300	350	23	00
34-64200	C64C 75-25-11-400/440-64	75	25	1:2	500	300	350	23	00
34-64845	C64C 75-12,5-11A-400/440-64	75	12.5	1:2:3	500	300	350	21	00
34-64203	C64C 87,5-12,5-111-400/440-64	87.5	12.5	1:2:4	500	300	350	24	00
34-64205	C64C 93,75-6,25-1111-400/440-64	93.75	6.25	1:2:4:8	500	300	350	24	00
34-64206	C64C 100-12,5-211-400/440-64	100	12.5	1:1:2:4	500	300	350	26	00
34-64208	C64C 100-25-21-400/440-64	100	25	1:1:2	500	300	350	29	00
34-64188	C64C 100-50-2-400/440-64	100	50	1:1	500	300	350	24	00

Other rated voltages, frequencies and power ratings on request.

Recommended supply lead cross sections: please refer to the technical annex (page 137 ff.).

PFC Systems on mounting plates / Capacitor Modules

Capacitor Modules

Article- No.	Type	Rated power	Step power	Switching sequence	Dimensions			Weight (gross) approx.	Protection IP
					Width	Height	Depth		
		[kvar]	[kvar]		[mm]	[mm]	[mm]	[kg]	

Capacitor Modules for installation in switchgear systems with a width of 800 mm, rated mains voltage: 400 V / 50 Hz

Type series: C84C

34-64289	C84C 25-3,13-211-400/440-84	25	3.13	1:1:2:4	700	300	350	16	00
34-64290	C84C 25-6,25-21-400/440-84	25	6.25	1:1:2	700	300	350	16	00
34-64213	C84C 25-12,5-2-400/440-84	25	12.5	1:1	700	300	350	16	00
34-64214	C84C 25-25-1-400/440-84	25	25	1	700	300	350	17	00
34-64291	C84C 31,25-6,25-12-400/440-84	31.25	6.25	1:2:2	700	300	350	17	00
34-64292	C84C 34,38-3,13-112-400/440-84	34.38	3.13	1:2:4:4	700	300	350	17	00
34-64293	C84C 37,5-6,25-22-400/440-84	37.5	6.25	1:1:2:2	700	300	350	17	00
34-64215	C84C 37,5-12,5-11-400/440-84	37.5	12.5	1:2	700	300	350	18	00
34-64294	C84C 43,75-6,25-111-400/440-84	43.75	6.25	1:2:4	700	300	350	18	00
34-64295	C84C 46,88-3,13-1111-400/440-84	46.88	3.13	1:2:4:8	700	300	350	19	00
34-64296	C84C 50-3,13-2111-400/440-84	50	3.13	1:1:2:4:8	700	300	350	19	00
34-64297	C84C 50-6,25-211-400/440-84	50	6.25	1:1:2:4	700	300	350	20	00
34-64217	C84C 50-12,5-21-400/440-84	50	12.5	1:1:2	700	300	350	20	00
34-64218	C84C 50-25-2-400/440-84	50	25	1:1	700	300	350	19	00
34-64219	C84C 50-50-1-400/440-84	50	50	1	700	300	350	20	00
34-64222	C84C 62,5-12,5-12-400/440-84	62.5	12.5	1:2:2	700	300	350	21	00
34-64298	C84C 68,75-6,25-112-400/440-84	68.75	6.25	1:2:4:4	700	300	350	21	00
34-64299	C84C 75-12,5-22-400/440-84	75	12.5	1:1:2:2	700	300	350	21	00
34-64224	C84C 75-25-11-400/440-84	75	25	1:2	700	300	350	21	00
34-64846	C84C 75-12,5-11A-400/440-84	75	12.5	1:2:3	700	300	350	21	00
34-64227	C84C 87,5-12,5-111-400/440-84	87.5	12.5	1:2:4	700	300	350	20	00
34-64229	C84C 93,75-6,25-1111-400/440-84	93.75	6.25	1:2:4:8	700	300	350	22	00
34-64126	C84C 100-12,5-211-400/440-84	100	12.5	1:1:2:4	700	300	350	24	00
34-64232	C84C 100-25-21-400/440-84	100	25	1:1:2	700	300	350	27	00
34-64127	C84C 100-50-2-400/440-84	100	50	1:1	700	300	350	26	00

Other rated voltages, frequencies and power ratings on request.

Recommended supply lead cross sections: please refer to the technical annex (page 137 ff.).

For options and accessory equipment for PFC Systems on mounting plates, module rails, ordering examples and dimensional drawings see page 87 ff.

PFC Systems on mounting plates / Capacitor Modules

Capacitor Modules – detuned



3

C64D-P / C84D-P / C65D-P / C85D-P Capacitor Modules – detuned

Capacitor Modules type C64D-P / C84D-P / C65D-P / C85D-P for installation in standard switchgear systems. Suitable for low-voltage networks with harmonic content.

- Power Range: 25 to 100 kvar per module
- Compact design - up to 5 modules per cabinet
- Ideal for mounting in all common switchgear systems
- Easy and quick mounting with multifunctional rails
- Power Factor Correction Capacitors LKT dry-type with four safety features

Application Recommendations

Capacitor modules type C64D-P, C65D-P, C84D-P and C85D-P are suitable for installation in standard switchgear systems. Additional mounting rails for all common switchgear systems:

- W = 600 mm, T = 400, 500, 600 mm resp.
- W = 800 mm, T = 400, 500, 600 mm

allow an easy and quick installation of complex Power Factor Correction Systems.

Suitable for supply networks with harmonic distortion according to EN 61000-2-4 class 2.

Available in the following versions:

Version	Detuning factor	Resonance frequency
P1	$p = 14 \%$	134 Hz
P7	$p = 7 \%$	189 Hz
P8	$p = 8 \%$	177 Hz
P5	$p = 5.67 \%$	210 Hz

PFC Systems on mounting plates / Capacitor Modules

Capacitor Modules – detuned

Power Range

Compact compensation module ideal for mounting in switchgear systems:

- 25 to 100 kvar

Construction

Sheet steel chassis with mounted power capacitors, contactors and fuses - ideal for mounting in all common switchgear systems.

The module consists of:

- Self-healing LKT type power capacitors with low-loss self-healing dielectric made from segmented metallised polypropylene film. Filled with a PCB-free filler. With discharge resistors, as per EN 60831-1 and -2 as well as IEC 60831-1 and -2
- Heavy duty Capacitor Switching Contactors
- Low-loss Harmonic Filter Reactors with temperature switches
- Busbar system with bus-mounting fuse base, 3-pole, size NH 00
- Control circuit with female connector (wired connector for connection with terminal strip incl.)

Installation Site

The place of installation must comply with the requirements of the ingress protection and ambient temperature concerned.

Regulations

For installation and connection of Power Factor Correction Capacitors in Germany the following regulations must be complied with: VDE 0100, VDE 0105, VDE 0560 Part 46 and VDE 0106 Part 100 (German Association of Electrical Engineers). In other countries the equivalent local regulations must be followed.

Installation

Specific module rails are required for installation in the switchgear system. Those module rails are available for all common switchgear systems and can be supplied as an optional accessory.

Connection

The network connection can be done either vertically or horizontally. For the horizontal connection one has to connect the cables equipped with the cable lugs to the busbar by using the M12 screws.

A bus connection bracket CU AW-1 for vertical connection is available as an option.

Additional modules can be connected directly via the busbar system.

Technical Data

Design	Sheet steel chassis for installation in switchgear cabinets C6xD... for cabinets (width = 600 mm) C8xD... for cabinets (width = 800 mm)
Rated voltage	400 V/50 Hz
Rated voltage of capacitors	440 V/50 Hz (-P5 to -P8) 480 V/50 Hz (-P1)
Ambient temperature	-5 °C to +60 °C
Humidity	Max. 90 %, no condensation
Standards	EN 60831-1 and -2 IEC 60831-1 and -2 EN 61921 IEC 61921 EN 61439-1 and -2 IEC 61439-1 and 2

Important Notes

For further information on power factor correction and harmonics please refer to our "Manual of Power Factor Correction".

PFC Systems on mounting plates / Capacitor Modules

Capacitor Modules – detuned

Version: P1 (Detuning factor p = 14 %)

Article- No.	Type	Rated power [kvar]	Step power [kvar]	Switching sequence	Dimensions			Weight (gross) approx. [kg]	Protection IP
					Width [mm]	Height [mm]	Depth [mm]		

Capacitor Modules for installation in switchgear systems with a width of 600 mm, rated mains voltage: 400 V / 50 Hz

Type series: C6xD ...-P1

34-64264	C64D 25-6,25-21-400/480-64-P1	25	6.25	1:1:2	500	300	350	57	00
34-64242	C64D 25-12,5-2-400/480-64-P1	25	12.5	1:1	500	300	350	45	00
34-64243	C64D 25-25-1-400/480-64-P1	25	25	1	500	300	350	49	00
34-65013	C65D 50-50-1-400/480-65-P1	50	50	1	500	300	450		00

Capacitor Modules for installation in switchgear systems with a width of 800 mm, rated mains voltage: 400 V / 50 Hz

Type series: C8xD ...-P1

34-64069	C84D 25-6,25-21-400/480-84-P1	25	6.25	1:1:2	700	300	350	47	00
34-64070	C84D 25-12,5-2-400/480-84-P1	25	12.5	1:1	700	300	350	47	00
34-64039	C84D 25-25-1-400/480-84-P1	25	25	1	700	300	350	51	00
34-64271	C84D 31,25-6,25-12-400/480-84-P1	31.25	6.25	1:2:2	700	300	350	46	00
34-64374	C84D 37,5-6,25-22-400/480-84-P1	37.5	6.25	1:1:2:2	700	300	350	52	00
34-64018	C84D 37,5-12,5-11-400/480-84-P1	37.5	12.5	1:2	700	300	350	45	00
34-64002	C84D 43,75-6,25-111-400/480-84-P1	43.75	6.25	1:2:4	700	300	350	78	00
34-64003	C84D 50-12,5-21-400/480-84-P1	50	12.5	1:1:2	700	300	350	83	00
34-64004	C84D 50-25-2-400/480-84-P1	50	25	1:1	700	300	350	80	00
34-64005	C84D 50-50-1-400/480-84-P1	50	50	1	700	300	350	69	00
34-65011	C85D 75-25-11-400/480-85-P1	75	25	1:2	700	300	450		00
34-64040	C85D 100-50-2-400/480-85-P1	100	50	1:1	700	300	450	118	00

Other rated voltages, frequencies and power ratings on request.

Recommended supply lead cross sections: please refer to the technical annex (page 137 ff.).

Version: P7 (Detuning factor p = 7 %)

Article- No.	Type	Rated power [kvar]	Step power [kvar]	Switching sequence	Dimensions			Weight (gross) approx. [kg]	Protection IP
					Width [mm]	Height [mm]	Depth [mm]		

Capacitor Modules for installation in switchgear systems with a width of 600 mm, rated mains voltage: 400 V / 50 Hz

Type series: C6xD ...-P7

34-65138	C65D 25-3,13-211-400/440-65-P7	25	3.13	1:1:2:4	500	300	350	44	00
34-64257	C64D 25-6,25-21-400/440-64-P7	25	6.25	1:1:2	500	300	350	44	00
34-64262	C64D 25-12,5-2-400/440-64-P7	25	12.5	1:1	500	300	350	44	00
34-64245	C64D 25-25-1-400/440-64-P7	25	25	1	500	300	350	33	00
34-64301	C64D 31,25-6,25-12-400/440-64-P7	31.25	6.25	1:2:2	500	300	350	45	00
34-64246	C64D 37,5-12,5-11-400/440-64-P7	37.5	12.5	1:2	500	300	350	44	00
34-64247	C64D 43,75-6,25-111-400/440-64-P7	43.75	6.25	1:2:4	500	300	350	54	00
34-64248	C64D 50-12,5-21-400/440-64-P7	50	12.5	1:1:2	500	300	350	55	00
34-64249	C64D 50-25-2-400/440-64-P7	50	25	1:1	500	300	350	47	00
34-64250	C64D 50-50-1-400/440-64-P7	50	50	1	500	300	350	49	00
34-64261	C65D 75-25-11-400/440-65-P7	75	25	1:2	500	300	450	65	00

PFC Systems on mounting plates / Capacitor Modules

Capacitor Modules – detuned

Article- No.	Type	Rated power [kvar]	Step power [kvar]	Switching sequence	Dimensions			Weight (gross) approx. [kg]	Protection IP
					Width [mm]	Height [mm]	Depth [mm]		

Capacitor Modules for installation in switchgear systems with a width of 800 mm, rated mains voltage: 400 V / 50 Hz

Type series: C8xD ...-P7

34-64071	C84D 25-6,25-21-400/440-84-P7	25	6.25	1:1:2	700	300	350	46	00
34-64072	C84D 25-12,5-2-400/440-84-P7	25	12.5	1:1	700	300	350	46	00
34-64015	C84D 25-25-1-400/440-84-P7	25	25	1	700	300	350	38	00
34-64339	C84D 31,25-6,25-12-400/440-84-P7	31.25	6.25	1:2:2	700	300	350	47	00
34-64303	C84D 34,38-3,13-112-400/440-84-P7	34.38	3.13	1:2:4:4	700	300	350	48	00
34-64211	C84D 37,5-12,5-11-400/440-84-P7	37.5	12.5	1:2	700	300	350	48	00
34-64304	C84D 37,5-6,25-22-400/440-84-P7	37.5	6.25	1:1:2:2	700	300	350	49	00
34-64073	C84D 43,75-6,25-111-400/440-84-P7	43.75	6.25	1:2:4	700	300	350	52	00
34-64305	C84D 46,88-3,13-1111-400/440-84-P7	46.88	3.13	1:2:4:8	700	300	350	57	00
34-64007	C84D 50-6,25-211-400/440-84-P7	50	6.25	1:1:2:4	700	300	350	50	00
34-64008	C84D 50-12,5-21-400/440-84-P7	50	12.5	1:1:2	700	300	350	60	00
34-64009	C84D 50-25-2-400/440-84-P7	50	25	1:1	700	300	350	55	00
34-64010	C84D 50-50-1-400/440-84-P7	50	50	1	700	300	350	52	00
34-64041	C84D 62,5-12,5-12-400/440-84-P7	62.5	12.5	1:2:2	700	300	350	55	00
34-64074	C84D 68,75-6,25-112-400/440-84-P7	68.75	6.25	1:2:4:4	700	300	350	56	00
34-64075	C84D 75-12,5-22-400/440-84-P7	75	12.5	1:1:2:2	700	300	350	59	00
34-64011	C84D 75-25-11-400/440-84-P7	75	25	1:2	700	300	350	71	00
34-64848	C84D 75-12,5-11A-400/440-84-P7	75	12.5	1:2:3	700	300	350	62	00
34-64012	C84D 87,5-12,5-111-400/440-84-P7	87.5	12.5	1:2:4	700	300	350	75	00
34-64648	C85D 100-12,5-211-400/440-85-P7	100	12.5	1:1:2:4	700	300	450	93	00
34-64013	C84D 100-25-21-400/440-84-P7	100	25	1:1:2	700	300	350	90	00
34-64014	C84D 100-50-2-400/440-84-P7	100	50	1:1	700	300	350	84	00

Versions with an 8 % choke factor are available with the same corrective power and configuration of the capacitance stages.

Other rated voltages, frequencies and power ratings on request.

Recommended supply lead cross sections: please refer to the technical annex (page 137 ff.).

PFC Systems on mounting plates / Capacitor Modules

Capacitor Modules – detuned

Version: P5 (Detuning factor $p = 5.67\%$)

Article- No.	Type	Rated power [kvar]	Step power [kvar]	Switching sequence	Dimensions			Weight (gross) approx. [kg]	Protection IP
					Width [mm]	Height [mm]	Depth [mm]		

Capacitor Modules for installation in switchgear systems with a width of 800 mm, rated mains voltage: 400 V / 50 Hz

Type series: C8xD ...-P5

34-64969	C84D 25-25-1-400/440-84-P5	25	25	1	700	300	350	58	00
34-64970	C84D 50-50-1-400/440-84-P5	50	50	1	700	300	350	67	00
34-64971	C84D 50-25-2-400/440-84-P5	50	25	1:1	700	300	350	80	00
34-64972	C84D 75-25-11-400/440-84-P5	75	25	1:2	700	300	350	98	00
34-64973	C85D 100-50-2-400/440-85-P5	100	50	1:1	700	300	450	120	00

Other rated voltages, frequencies and power ratings on request.

Recommended supply lead cross sections: please refer to the technical annex (page 137 ff.).

For options and accessory equipment for PFC Systems on mounting plates, module rails, ordering examples and dimensional drawings see page 87 ff.

Accessory equipment for PFC Systems and modules

Accessory equipment for PFC Systems on mounting plates

Page 87

Ordering examples

Page 95

Accessory equipment for PFC Systems and modules

Accessory equipment for PFC Systems on mounting plates



Accessory equipment for PFC Systems on mounting plates

4

In addition to Capacitor Modules type C or Power Factor Correction Systems on mounting plates type LSP, further components are required to assemble a Power Factor Correction System.

FRAKO offers accessory packages which contain all necessary components to assemble such a PFC-System. Those packages include:

- Power Factor Control Relays and accessories
- Mounting plates
- Module rails
- Ventilation packages
- Bus connection bracket

Power Factor Control Relays and accessories

For technical details on our Power Factor Control Relays please refer to chapter "Power Factor Control Relays".

For the relays, FRAKO recommends to use suitable control terminal strips with control fuse and thermal trip contact for monitoring the cabinet temperature as well as the connecting cables for the relay. All items can be ordered as single components or as a complete power factor control relay package.

Accessory equipment for PFC Systems and modules

Accessory equipment for PFC Systems on mounting plates

Accessories

Article-No.	Type	Description
-------------	------	-------------

Power Factor Control Relays

38-00320	RM 2106	With 6 control contacts
38-00340	RM 2112	With 12 control contacts
38-00402	PQC 0602401-0	With 6 control contacts, single-phase
38-00400	PQC 1202401-0	With 12 control contacts, single-phase
38-00417	PQC 0602401-20	With 6 control contacts, single-phase with Modbus RTU
38-00416	PQC 0602401-01	With 6 control contacts, single-phase with temperature and I/O extension
38-00418	PQC 0602401-21	With 6 control contacts, single-phase with Modbus RTU + temperature and I/O extension
38-00419	PQC 0602401-30	With 6 control contacts, single-phase with Modbus TCP
38-00420	PQC 0602401-31	With 6 control contacts, single-phase with Modbus TCP + temperature and I/O extension
38-00404	PQC 1202401-20	With 12 control contacts, single-phase with Modbus RTU
38-00403	PQC 1202401-01	With 12 control contacts, single-phase with temperature and I/O extension
38-00405	PQC 1202401-21	With 12 control contacts, single-phase with Modbus RTU + temperature and I/O extension
38-00408	PQC 1202401-30	With 12 control contacts, single-phase with Modbus TCP
38-00409	PQC 1202401-31	With 12 control contacts, single-phase with Modbus TCP + temperature and I/O extension
39-29060	PFC-12TR-1	With 24 control contacts, 12 relays / 12 transistors
39-29061	PFC-12TR-1-RS485	With 24 control contacts, 12 relays / 12 transistors + RS485 interface

Control terminal strip with thermal trip contact, premounted

34-80399	RKL-PQC-6/1	Suitable for PQC with 6 control contacts, single-phase
34-80400	RKL-PQC-12/1	Suitable for PQC with 12 control contacts, single-phase
34-80027	RKL-Z-Schrank	For extension units (only 12 control contacts)

Control cable set, prefabricated for the connection between power factor control relay and control terminal strip RKL

34-80407	RKS-PQC 6-1300	For connection of PQC with 6 control contacts, single-phase, cable length 1.3 m
34-80409	RKS-PQC 6-2400	For connection of PQC with 6 control contacts, single-phase, cable length 2.4 m
34-80406	RKS-PQC 12-1300	For connection of PQC with 12 control contacts, single-phase, cable length 1.3 m
34-80410	RKS-PQC 12-2400	For connection of PQC with 12 control contacts, single-phase, cable length 2.4 m
89-20559	SS 12-6000	For connecting the basic unit with the extension unit (length: 6 m)

Power Factor Control Relay packages (premounted and wired), consisting of:

Power Factor Control Relay, control terminal strip, set of relay cables and optional modules

Article-No.	Type	Description
-------------	------	-------------

Cable set 1.300 mm, PQC single-phase, 12 control contacts

34-72109	STR-PQC 650-1300	Basic version (incl. controller 38-00400)
34-72128	STR-PQC 652-1300	With Modbus RTU (incl. controller 38-00404)
34-72130	STR-PQC 651-1300	With temperature I/O (incl. controller 38-00403)
34-72172	STR-PQC 654-1300	With Modbus TCP (incl. controller 38-00408)

Cable set 1.300 mm, PQC single-phase, 6 control contacts

34-72108	STR-PQC 620-1300	Basic version (incl. controller 38-00402)
34-72127	STR-PQC 622-1300	With Modbus RTU (incl. controller 38-00417)
34-72129	STR-PQC 621-1300	With temperature I/O (incl. controller 38-00416)
34-72173	STR-PQC 624-1300	With Modbus TCP (incl. controller 38-00419)

Cable set 2.400 mm, PQC single-phase, 12 control contacts

34-72111	STR-PQC 650-2400	Basic version (incl. relay 38-00400)
34-72134	STR-PQC 652-2400	With Modbus RTU (incl. controller 38-00404)
34-72136	STR-PQC 651-2400	With temperature I/O (incl. controller 38-00403)
34-72174	STR-PQC 654-2400	With Modbus TCP (incl. controller 38-00408)

Accessory equipment for PFC Systems and modules

Accessory equipment for PFC Systems on mounting plates

Article-No.	Type	Description
Cable set 2.400 mm, PQC single-phase, 6 control contacts		
34-72110	STR-PQC 620-2400	Basic version (incl. controller 38-00402)
34-72133	STR-PQC 622-2400	With Modbus RTU (incl. controller 38-00417)
34-72135	STR-PQC 621-2400	With temperature I/O (incl. controller 38-00416)
34-72175	STR-PQC 624-2400	With Modbus TCP (incl. controller 38-00419)
Additional Power Factor Control Relay packages:		
34-72214	STR-PFC 12TR-1-2400	PFC-12TR-1, control terminal strip, cable set 2.4 m
34-72215	STR-PFC 12TR-1-RS485-2400	PFC-12TR-1-RS485, control terminal strip, cable set 2.4 m
34-72155	STR-PQC 652-1300 with BU-PROFIBUS DP	PQC 652 with bus converter PROFIBUS DP, cable length 1.3 m
34-72166	STR-PQC 652-1300 with BU-PROFINET	With bus converter PROFINET, cable length 1.3 m
34-80056	SBS-PS 24 VDC-0.63 A	Power supply unit (24 VDC / 0.63 A output) for actuating the electronic switches
Mounting plates for control terminal strip, control transformers etc.		
34-80069	SB-C6	For cabinets width 600 mm
34-80053	SB-C8	For cabinets width 800 mm

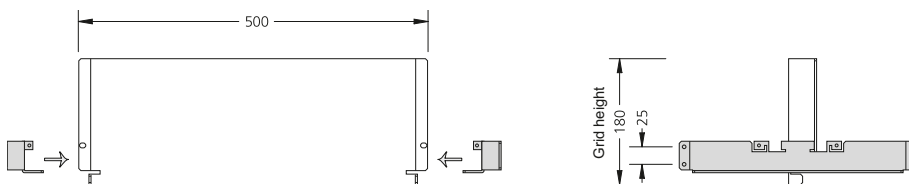

Dimensional drawing SB-C6 with module rail

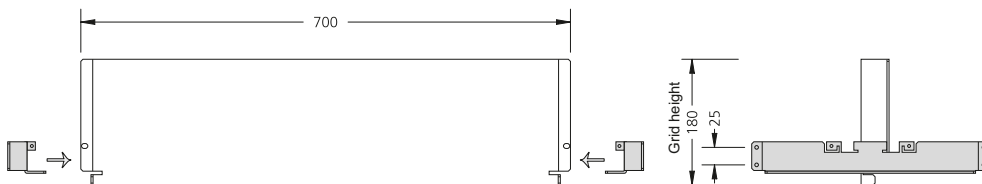

Dimensional drawing SB-C8 with module rail

Article-No.	Type	Description
Ventilation packages, consisting of:		
34-80096	LP-LSFC-I IP20-6/1	1 pc roof vent, installation in cabinet, 1 pc air inlet filter and thermostat
34-80285	LP-LSFC-A IP43-7/1	1 pc roof vent, installation outside of the cabinet, 1 pc air inlet filter and thermostat
34-80379	LP-LSFC-IP54	1 pc door vent, installation in cabinet, 1 pc air inlet filter and thermostat
Bus connection bracket		
34-80006	CU AW-1	Busbar bracket set for cable connection, complete with fixing screws and protection against accidental contact
34-80114	Final cover complete	Protection against accidental contact (module packages do not include CU-AW 1)

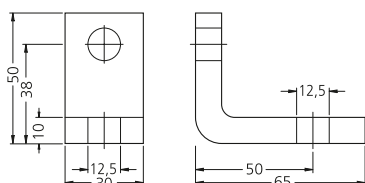

Dimensional drawing CU AW-1

All dimensions in mm

Accessory equipment for PFC Systems and modules

Accessory equipment for PFC Systems on mounting plates

Selection of module rails for the most common switchgear systems

Article-No.	Manufacturer of cabinet	Cabinet type	Cabinet width [mm]	Cabinet depth [mm]
34-80051	ABB	MNS (with distribution busbars)	800	600
34-80176	ABB	MNS (without distribution busbars)	800	600
34-80128	ABB	RNS	800	600
34-80389	ABB	ARTU K	920	637
34-80384	ABB	PRO E POWER	700/900	600
34-80211	ABN	BST312	830	525
34-80133	AEG	EVS	800	400
34-80180	AEG	EVS	800	600
34-80071	CEGELEC	Intermas	800	500
34-80072	CEGELEC	Intermas	800	600
34-80179	DESSAUER	Dessa Norm	800	600
34-80201	DESSAUER	Dessa Norm	800	800
34-80039	EATON / MOELLER	IVS1600	800	400
34-80071	EATON / MOELLER	IVS1600	800	500
34-80072	EATON / MOELLER	IVS1600	800	600
34-80138	EATON / MOELLER	SVTL	800	400
34-80130	EATON / MOELLER	SVTL	800	600
34-80173	EATON / MOELLER	xEnergy (with distribution busbars)	800	600
34-80174	EATON / MOELLER	xEnergy (without distribution busbars)	800	600
34-80148	ELDON	MCS	800	400
34-80152	ELDON	MCS	800	500
34-80233	ELDON	MCS	800	600
34-80067	ELEK	UR / URV	800	400
34-80105	ELEK	UR / URV	800	600
34-80073	ELEK	UR / URV	800	800
34-80059	ELEK	UR / URV	850	400
34-80050	ELEK	UR / URV	850	600
34-80132	ELEK	UR / URV	850	800
34-80120	ELIN-EBG	ELIN-EBG SV	800	600
34-80120	ELIN-EBG	SVT	800	600
34-80172	ELSTEEL	Elsteel	800	600
34-80147	ELSTEEL	Elsteel	800	800
34-80238	ELSTEEL	Elsteel (with busbar space)	800	600
34-80040	FRAKO	LSFC and GE(AEG) SEN	600/800	400
34-80041	FRAKO	LSFC	600/800	500
34-80042	FRAKO	LSFC and GE(AEG) SEN	600/800	600
34-80253	GE	VPS STEEL	800	400
34-80181	HAGER	Hager FG22	600	600
34-80214	HAGER	Hager FG23	850	400
34-80055	HENSEL	SAS 2000 (frame assembly)	850	500
34-80168	HENSEL	SAS 2000 (M. Plate brackets reinforced assembly)	600	500
34-80190	HENSEL	SAS 2000 (M. Plate brackets reinforced assembly)	850	500
34-80154	ISA	ISA 2000	800	800
34-80119	LÖGSTRUP	Cabinet is only suitable for C6X modules	760	570
34-80077	LÖGSTRUP	Cabinet is only suitable for C6X modules	760	760

Accessory equipment for PFC Systems and modules

Accessory equipment for PFC Systems on mounting plates

Article-No.	Manufacturer of cabinet	Cabinet type	Cabinet width [mm]	Cabinet depth [mm]
34-80227	LOHMEIER	RS	800	600
34-80228	LOHMEIER	RS	800	800
34-80198	MEHLER	ARM-C	800	400
34-80106	MEHLER	SRM-C	800	600
34-80097	MONA	MONA 5000	800	400
34-80098	MONA	MONA 5000	800	600
34-80245	MONA	MONA 5000	800	800
34-80047	RITTAL	ES4... / PS4...	600/800	400
34-80048	RITTAL	ES4... / PS4...	600/800	500
34-80049	RITTAL	ES4... / PS4...	600/800	600
34-80293	RITTAL	ES4... / PS4...	600/800	800
34-80040	RITTAL	TS8...	600/800	400
34-80041	RITTAL	TS8...	600/800	500
34-80042	RITTAL	TS8...	600/800	600
34-80137	RITTAL	TS8...	600/800	800
34-80435	RITTAL	VX25	600/800	400
34-80436	RITTAL	VX25	600/800	500
34-80437	RITTAL	VX25	600/800	600
34-80438	RITTAL	VX25	600/800	800
34-80134	SAREL	S6000	800	500
34-80237	SAREL	S6000	800	600
34-80291	SCHNEIDER	Prisma P	650	600
34-80284	SCHNEIDER	Prisma P (with busbar space)	800	600
34-80070	SIEMENS	Sivacon 8PT	800	600
34-80155	SIEMENS	Sivacon 8PT	800	800
34-80223	SIEMENS	Sivacon 8PT	850	600
34-80153	SIEMENS	Sivacon 8PT (with distribution busbars)	800	600
34-80255	SIEMENS	Sivacon S8 (Siemens S8- compensation section with busbar terminals on the rear side)	800	600
34-80252	SIEMENS	Sivacon S8 (normal section. FRAKO disassembling without busbar terminals on the rear side)	800	600
34-80076	STRIEBEL&JOHN	2/8XA4	600	400
34-80115	STRIEBEL&JOHN	2/8XA6	600	600
34-80104	STRIEBEL&JOHN	3/8XA4	850	400
34-80061	STRIEBEL&JOHN	3/8XA6	850	600
34-80222	STRIEBEL&JOHN	3/8XA8	850	800
34-80251	STRIEBEL&JOHN	Triline-R	614	425
34-80212	STRIEBEL&JOHN	Triline-R	614	625
34-80182	STRIEBEL&JOHN	Triline-R	864	425
34-80141	STRIEBEL&JOHN	Triline-R	864	625
34-80250	STRIEBEL&JOHN	Triline-R	864	825
34-80269	WEBER	MES	800	600
34-80178	WEBER	PM8	800	400
34-80129	WEBER	PM8	800	500
34-80218	WEBER	PM8	800	600

Other module rails on request

Accessory equipment for PFC Systems and modules

Accessory equipment for PFC Systems on mounting plates

Dimensions

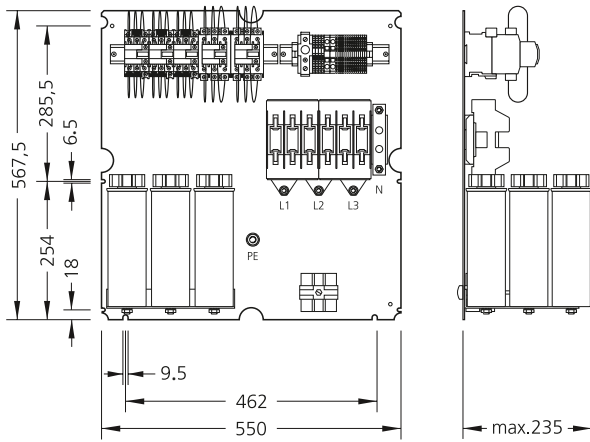

Dimensional drawing LSP-2 (68.75-100 kvar)

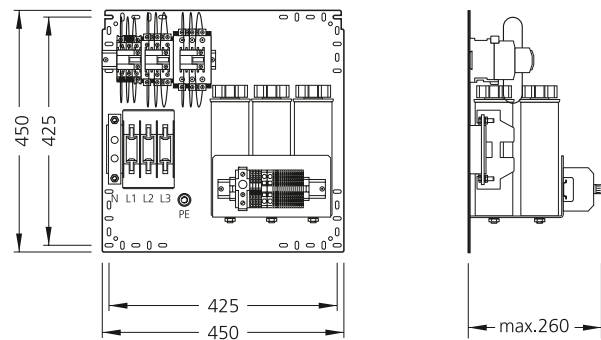

Dimensional drawing LSPN-4 (17.5-60 kvar)

4

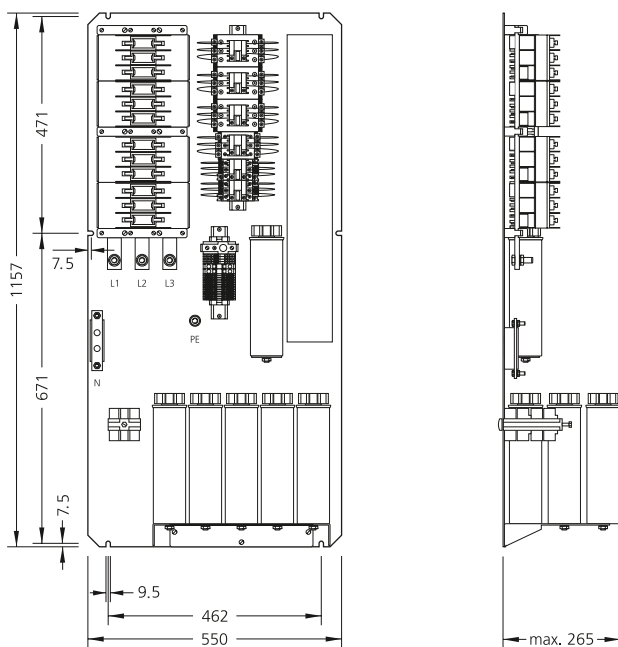

Dimensional drawing LSP-3 (112.5-200 kvar)

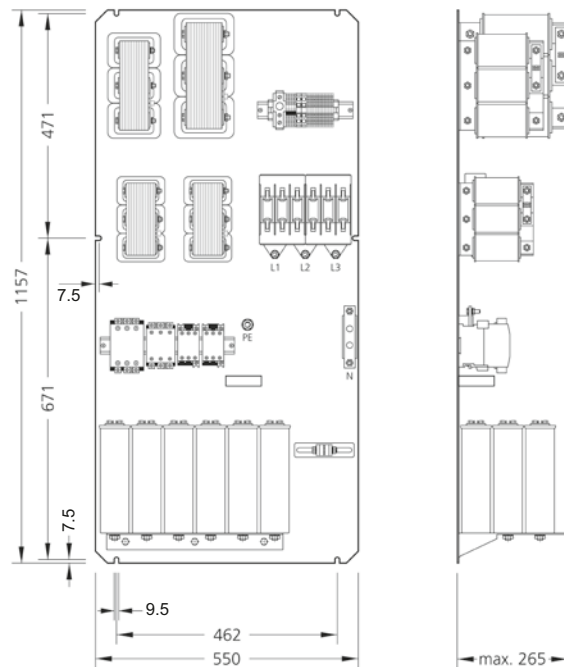

Dimensional drawing LSP-P (17.5-100 kvar)

All dimensions in mm

Accessory equipment for PFC Systems and modules

Accessory equipment for PFC Systems on mounting plates

Dimensions

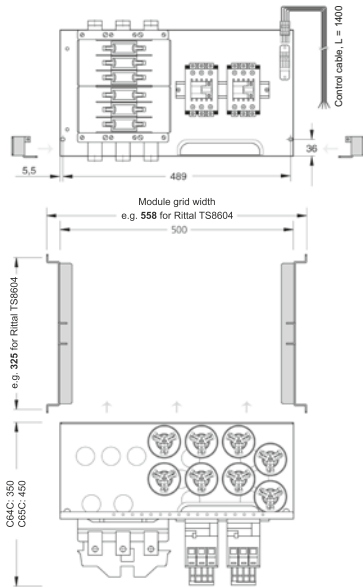

Dimensional drawing type series C64C (25 to 100 kvar) with module rails (here: MT-C6-Rittal VX 8604)

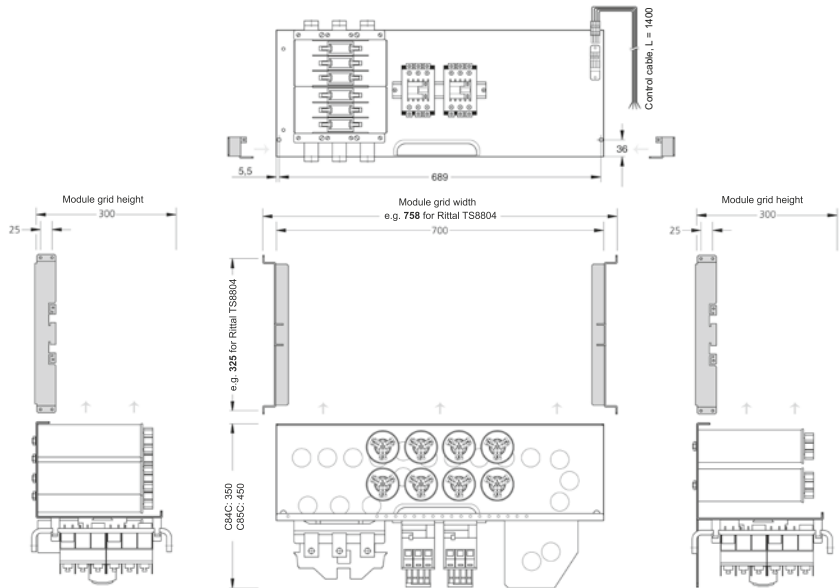

Dimensional drawing type series C84C (25 to 100 kvar) with module rails (here: MT-C8-Rittal VX 8804)

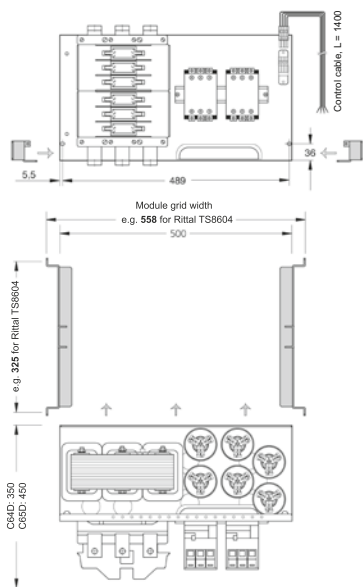

Dimensional drawing type series C64D (25 to 100 kvar) with module rails (here: MT-C6-Rittal VX 8604)

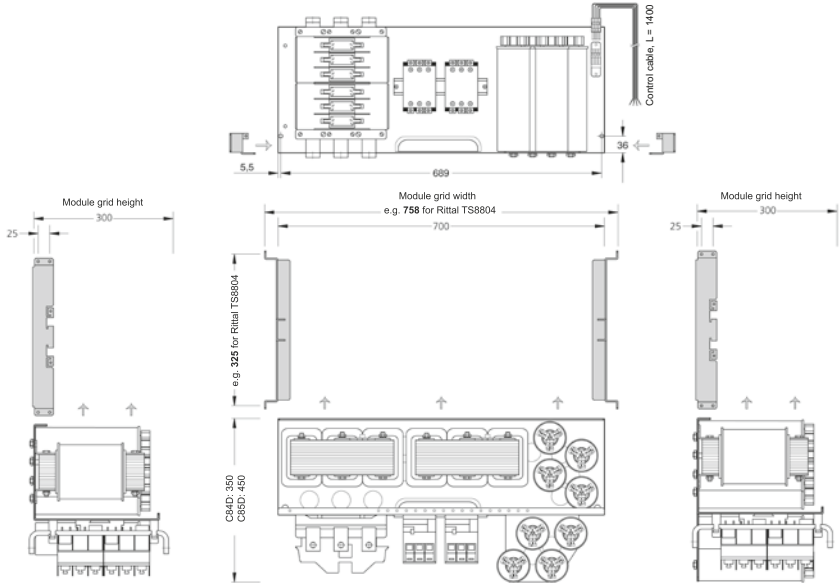

Dimensional drawing type series C84D (25 to 100 kvar) with module rails (here: MT-C8-Rittal VX 8804)

All dimensions in mm

Accessory equipment for PFC Systems and modules

Accessory equipment for PFC Systems on mounting plates

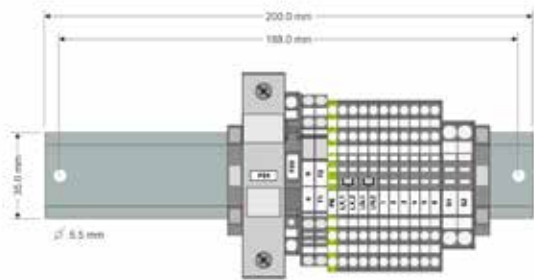

RKL-PQC-6-1

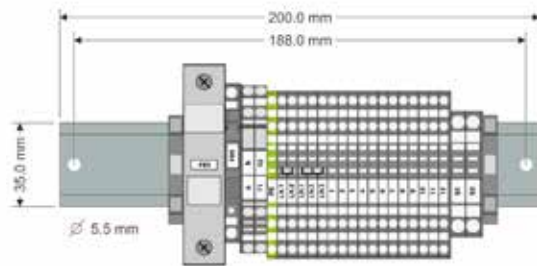

RKL-PQC-12-1

4

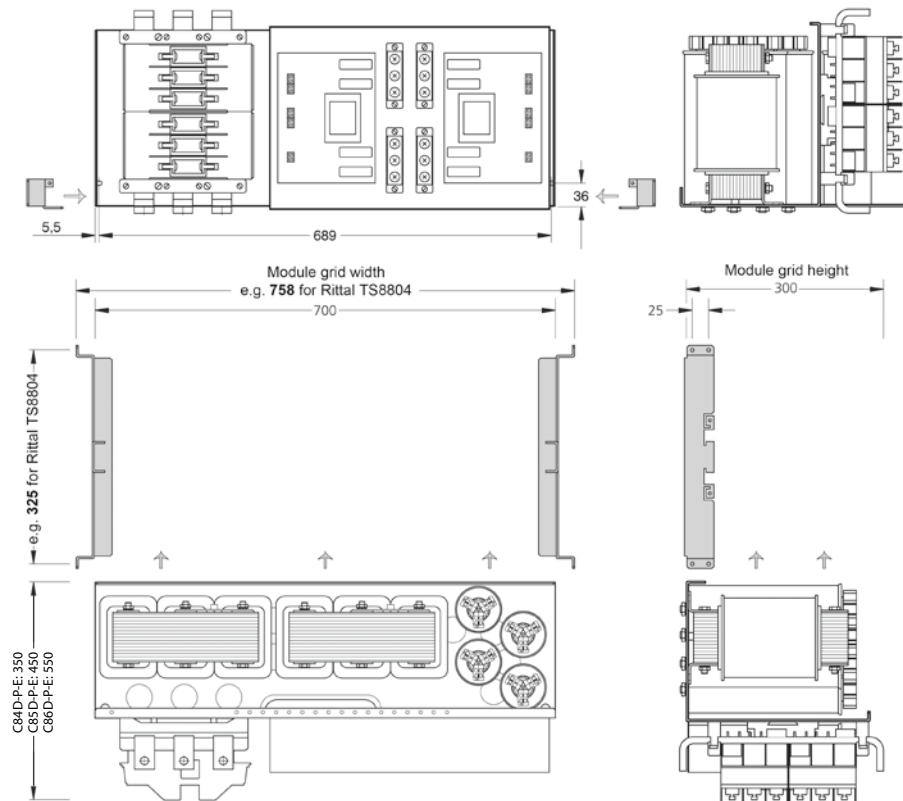

Dimensional drawing type C84D-P-E / C85D-P-E / C86D-P-E (25 to 100 kvar)
with module rails (here: MT-C8-Rittal VX 8804)

Accessory equipment for PFC Systems and modules

Ordering examples

Ordering examples

Example of mounting plates without detuning for installation in enclosure systems supplied by others

Selection criteria:

• 1. Selecting the modules:

The mounting plates are selected according to:

- Required corrective power (max. 200 kvar)
- Required stage corrective power, smallest required stage corrective power

e.g. 150 kvar total corrective power with 12.5 kvar stages

Typical type specification: LSP 150–12,5–212–400/440–3
see page 71

• 2. Selecting the required accessories:

e.g.:

- Control cable set (with the required length)
(e.g. RKS-PQC 6-1300, with 1500 mm total length)
see page 88

• 3. Selecting the required reactive power control relay:

The control relay is selected to suit the number of switchable stages and additional functions required:

- up to 6 switchable stages: 6-stage control relay
(e.g. PQC 0602401-0)
- up to 12 switchable stages: 12-stage control relay
(e.g. PQC 1202401-0)

see page 88

Ordering example 1

• Description:

Example: Installation of mounting plate without detuning, with the following specifications, in an existing sheet steel cabinet:

- **Total corrective power:** 150 kvar, 400 V, 50 Hz
- **Stage corrective power:** 12.5 kvar
- **6-stage reactive power control relay**
- **Control cable set 1300 mm long (1500 mm total length)**

Article-No.	Description	Quantity
34-57063	LSP 150-12,5-212-400/440-3	1
92-11303	Control cable set: RKS-PQC 6-1300	1
38-00402	Control relay: PQC 0602401-0	1

Ordering example 2

• Description:

Example: Installation of mounting plate without detuning, with the following specifications, in an existing sheet steel cabinet:

- **Total corrective power:** 43.75 kvar, 400 V, 50 Hz
- **Stage corrective power:** 6.25 kvar
- **6-stage reactive power control relay**
- **Control cable set 1300 mm long (1500 mm total length)**

Article-No.	Description	Quantity
34-57535	LSPN 43,75-6,25-111-400/440-4	1
92-11303	Control cable set: RKS-PQC 6-1300	1
38-00402	Control relay: PQC 0602401-0	1

Accessory equipment for PFC Systems and modules

Ordering examples

Ordering examples

Example of module packages without detuning for installation in enclosure systems supplied by others

Selection criteria:

• 1. Selecting the modules:

The modules are selected according to:

- Required number and size of the stages, smallest required stage corrective power
- The planned enclosure system with its available dimensions

e.g. 100 kvar with 2 x 50 kvar stages and 50 kvar with 2 x 25 kvar stages in an enclosure 800 mm wide and 400 mm deep

Typical type specification: C84C 100-50-2-400/440-84 and C84C 50-25-2-400/440-84
see page 80

• 2. Selecting the mounting rail sets:

The mounting rail sets are selected to suit the existing or planned enclosure system (e.g. Rittal VX25).

One mounting rail set is required per module. An additional set is needed for the mounting plate (control terminal strips).

Typical type specification: Rittal VX25 W x D 800 x 400 mm
see page 91

• 3. Selecting the required accessories:

e.g.:

- Connection bracket set (e.g. CU AW-1)
- Ventilation set (e.g. LP-LSFC-A IP43-7/1)
- Mounting plates for control terminal strips (e.g. SB-C8)
see page 89

• 4. Selecting the required control relay package:

The control relay package is selected to suit the number of switchable stages required:

- up to 6 switchable stages: 6-stage control relay package (e.g. STR-PQC 06)
- Up to 12 switchable stages: 12-stage control relay package (e.g. STR-PQC 12)
see page 88

Ordering example 1

• Description:

Example: Assembly of a power factor correction system, without detuning, with the following specifications, in a sheet steel cabinet:

- **Total corrective power:** 250 kvar, 400 V, 50 Hz
- **Stage corrective power:** 2 x 25 kvar and 4 x 50 kvar
- **6-stage reactive power control relay**
- **Rittal VX25 baying system**

Article-No.	Description	Quantity
34-64127	C84C 100-50-2-400/440-84	2
34-64218	C84C 50-25-2-400/440-84	1
34-80040	TSC Rittal VX25 W x D 800 x 400 mm	4
34-80006	Connection bracket set CU AW-1	1
34-80285	Ventilation set LP-LSFC-A IP43-7/1	1
34-80053	Mounting plates for control terminal strips, control transformer, etc. SB-C8	1
34-72108	STR-PQC 620-1300, control terminal strip with thermal trip contact, cable 1300 mm long	1

Ordering example 2

• Description:

Example: Assembly of a power factor correction system, without detuning, with the following specifications, in a sheet steel cabinet:

- **Total corrective power:** 350 kvar, 400 V, 50 Hz
- **Stage corrective power:** 2 x 25 kvar and 6 x 50 kvar
- **12-stage reactive power control relay**
- **Rittal VX25 baying system**

Article-No.	Description	Quantity
34-64127	C84C 100-50-2-400/440-84	3
34-64218	C84C 50-25-2-400/440-84	1
34-80040	TSC Rittal VX25 W x D 800 x 400 mm	5
34-80006	Connection bracket set CU AW-1	1
34-80285	Ventilation set LP-LSFC-A IP43-7/1	1
34-80053	Mounting plates for control terminal strips, control transformer, etc. SB-C8	1
34-72109	STR-PQC 650-1300, control terminal strip with thermal trip contact, cable 1300 mm long	1

Accessory equipment for PFC Systems and modules

Ordering examples

Ordering examples

Example of mounting plates, detuned, for installation in enclosure systems supplied by others

Selection criteria:

• 1. Selecting the modules:

The mounting plates are selected according to:

- Required corrective power (max.100 kvar)
- Required stage corrective power
- Required detuning factor

e.g. 93.75 kvar total corrective power with 6.25 kvar stages and 7 % detuning factor.

Typical type specification: LSP 93,75–6,25–1111–400/440–3–P7
see page 76

• 2. Selecting the required accessories:

e.g.:

- Control cable set (with the required length)
(e.g. RKS-PQC 6-1300)

see page 88

• 3. Selecting the required reactive power control relay:

The control relay is selected to suit the number of switchable stages and additional functions required:

- up to 6 switchable stages: 6-stage control relay
(e.g. PQC 0602401-0)
- up to 12 switchable stages: 12-stage control relay
(e.g. PQC 1202401-0)

see page 88

Ordering example

• Description:

Example: Installation of a detuned mounting plate, with the following specifications, in an existing sheet steel cabinet:

- **Total corrective power: 93.75 kvar, 400 V, 50 Hz**
- **Stage corrective power: 6.25 kvar, 7 % choke factor**
- **6-stage reactive power control relay**
- **Control cable set 1300 mm long**

Article-No.	Description	Quantity
34-57728	LSP 93,75-6,25-1111-400/440-3-P7	1
92-11303	Control cable set: RKS-PQC 6-1300	1
38-00402	Control relay PQC 0602401-0	1

Accessory equipment for PFC Systems and modules

Ordering examples

Ordering examples

Example of module packages using detuned modules for installation in enclosure systems supplied by others

Selection criteria:

• 1. Selecting the modules:

The modules are selected according to:

- Required number and size of the stages, smallest required stage corrective power
- The planned enclosure system with its available dimensions

e.g. 100 kvar with 2 x 50 kvar stages and 50 kvar with 2 x 25 kvar stages in an 800 mm wide and 400 mm deep cabinet

Typical type specification: C84D 100-50-2-400/440-84-P7 and C84D 50-25-2-400/440-84-P7
see page 84

• 2. Selecting the mounting rail sets:

The mounting rail sets are selected to suit the existing or planned enclosure system (e.g. Rittal VX25).

One mounting rail set is required per module. An additional set is needed for the mounting plates (control terminal strips).

Typical type specification: Rittal VX25 W x D 800 x 400 mm
see page 91

• 3. Selecting the required accessories:

The required accessories, e.g.

- Connection bracket set (e.g. CU AW-1)
- Ventilation set (e.g. LP-LSFC-A IP43-7/1)
- Mounting plates for control terminal strips (e.g. SB-C8)
see page 89

• 4. Selecting the required control relay package:

The control relay package is selected to suit the number of switchable stages required:

- up to 6 switchable stages: 6-stage control relay package (e.g. STR-PQC 06)
- up to 12 switchable stages: 12-stage control relay package (e.g. STR-PQC 12)
see page 88

Ordering example 1

• Description:

Example: Assembly of a detuned power factor correction system with the following specifications for a sheet steel cabinet:

- **Total corrective power:** 250 kvar, 400 V, 50 Hz
- **Stage corrective power:** 2 x 25 kvar and 4 x 50 kvar
- **6-stage reactive power control relay**
- **Rittal VX25 baying system**

Article-No.	Description	Quantity
34-64014	C84D 100-50-2-400/440-84-P7	2
34-64009	C84D 50-25-2-400/440-84-P7	1
34-80040	TSC Rittal VX25 W x D 800 x 400 mm	4
34-80006	Connection bracket set CU AW-1	1
34-80285	Ventilation set LP-LSFC-A IP43-7/1	1
34-80053	Mounting plates for control terminal strips, control transformer, etc. SB-C8	1
34-72108	STR-PQC 620-1300, control terminal strip with thermal trip contact, cable 1300 mm long	1

Ordering example 2

• Description:

Example: Assembly of a detuned power factor correction system with the following specifications for a sheet steel cabinet:

- **Total corrective power:** 350 kvar, 400 V, 50 Hz
- **Stage corrective power:** 2 x 25 kvar and 6 x 50 kvar
- **12-stage reactive power control relay**
- **Rittal VX25 baying system**

Article-No.	Description	Quantity
34-64014	C84D 100-50-2-400/440-84-P7	3
34-64009	C84D 50-25-2-400/440-84-P7	1
34-80040	TSC Rittal VX25 W x D 800 x 400 mm	5
34-80006	Connection bracket set CU AW-1	1
34-80285	Ventilation set LP-LSFC-A IP43-7/1	1
34-80053	Mounting plates for control terminal strips, control transformer, etc. SB-C8	1
34-72109	STR-PQC 650-1300, control terminal strip with thermal trip contact, cable 1300 mm long	1

Accessory equipment for PFC Systems and modules

Ordering examples

Ordering examples

Example of module packages using detuned dynamic modules, for installation in enclosure systems supplied by others
Capacitor-reactor modules, wear-free and fast-acting, with electronic switching for 100 % duty cycle

Selection criteria:

• 1. Selecting the dynamic modules:

The modules are selected according to:

- Required number and size of the stages, smallest required stage corrective power
- The planned enclosure system with its available dimensions

e.g. 100 kvar with 2 x 50 kvar stages and 50 kvar with 2 x 25 kvar in an enclosure 800 mm wide and 400 mm deep

Typical type specifications: C85D 100-50-2-400/440-85-P7-E and C84D 50-25-2-400/440-84-P7-E

see page 161

• 2. Selecting the mounting rail sets:

The mounting rail sets are selected to suit the existing or planned enclosure system (e.g. Rittal VX25).

One mounting rail set is required per module. An additional set is needed for the mounting plates (control terminal strips).

Typical type specification: Rittal VX25 W x D 800 x 500 mm
 see page 91

• 3. Selecting the required accessories:

e.g.:

- Connection bracket set (e.g. CU AW-1)
 - Ventilation set (e.g. LP-LSFC-A IP43-7/1)
 - Mounting plates for control terminal strips (e.g. SB-C8)
- see page 89

• 4. Selecting the required control relay package:

The control relay package is selected to suit the number of switchable stages required:

- up to 6 switchable stages: 6-stage control relay package (e.g. STR-PQC 06, or fast-acting STR-RM 2012)
- up to 12 switchable stages: 12-stage control relay package (e.g. STR-PQC 12, or fast-acting STR-RM 2012 with reaction times in the range 20 to 40 ms)

see page 88

Ordering example 1

• Description:

Example: Assembly of a detuned dynamic power factor correction system with the following specifications for a sheet steel cabinet

- **Total corrective power:** 250 kvar, 400 V, 50 Hz
- **Stage corrective power:** 2 x 25 kvar and 4 x 50 kvar
- **6-stage reactive power control relay**
- **Rittal VX25 baying system**

Article-No.	Description	Quantity
34-64032	C85D 100-50-2-400/440-85-P7-E	2
34-64029	C84D 50-25-2-400/440-84-P7-E	1
34-80041	TSC Rittal VX25 W x D 800 x 500 mm	4
34-80006	Connection bracket set CU AW-1	1
34-80285	Ventilation set LP-LSFC-A IP43-7/1	1
34-80053	Mounting plates for control terminal strips, control transformer, etc. SB-C8	1
34-72108	* STR-PQC 620-1300, control terminal strip with thermal trip contact, cable 1300 mm long	1
34-72214	STR-PFC 12TR-1-2400, (with control terminal strip with thermal trip contact, cable 2.4 m long)	1
34-80056	*** SBS-PS 24 V DC-0.63 A power supply unit (24 V DC / 0.63 A output) for actuating the electronic switches	1

Ordering example 2

• Description:

Example: Assembly of a detuned dynamic power factor correction system with the following specifications for a sheet steel cabinet:

- **Total corrective power:** 300 kvar, 400 V, 50 Hz
- **Stage corrective power:** 6 x 50 kvar
- **6-stage reactive power control relay**
- **Rittal VX25 baying system**

Article-No.	Description	Quantity
34-64032	C85D 100-50-2-400/440-85-P7-E	3
34-80041	TSC Rittal VX25 W x D 800 x 500 mm	6
34-80006	Connection bracket set CU AW-1	1
34-80285	Ventilation set LP-LSFC-A IP43-7/1	1
34-80053	Mounting plates for control terminal strips, control transformer, etc. SB-C8	1
34-72108	* STR-PQC 620-1300, control terminal strip with thermal trip contact, cable 1300 mm long	1
34-72214	STR-PFC 12TR-1-2400, (with control terminal strip with thermal trip contact, cable 2.4 m long)	1
34-80056	*** SBS-PS 24 V DC-0.63 A power supply unit (24 V DC / 0.63 A output) for actuating the electronic switches	1

* This option is necessary if wear-free switching is required.

** This option is necessary if it is not only wear-free switching that is required but also fast-acting switching with reaction times of 20 to 40 ms.

*** Necessary to supply DC power to actuate the modules

PFC Systems

Power Factor Correction Systems

Page 101

Power Factor Correction Systems – detuned

Page 115

MCS – Modular Construction System

Page 133

PFC Systems

Power Factor Correction Systems



Power Factor Correction Systems

Ready to connect, automatic Power Factor Correction Systems in sheet steel cabinets for wall mounting or floor installation.

- Power Range: 17.5 to 500 kvar per cabinet
- Ready for connection
- Fully automatic and intelligent Power Factor Control Relay
- Power Factor Correction Capacitors LKT dry type with four safety features

Application Recommendations

Power Factor Correction Systems are suitable for networks without harmonic distortion.

Attention: Even low harmonic levels can be amplified by network resonances. High harmonic levels can overload or damage all electrical devices and machines in the network.

Nowadays networks without harmonic distortion are quite rare. Therefore we generally recommend installing fixed capacitors with harmonic filter reactors (page 115 ff.).

Power Factor Correction Systems

Power Factor Correction Systems

	LSK	LSFC
		
Power range [kvar]	17.5 - 200	100 - 500
System design	Compact	Modular
Enclosure	Wall-mounting	Floor-standing
Enclosure material	Sheet steel	Sheet steel
Power Factor Control Relay	PQC	PQC
Connection option from below	•	•
Connection option from top (optional)	-	•
Extension unit	LSKZ	LSFCZ
Catalogue page	Page 103 ff.	Page 109 ff.

Power Factor Correction Systems

Power Factor Correction Systems



LSK / LSKI Power Factor Correction Systems

Ready to connect, automatic Power Factor Correction Systems in sheet steel cabinets for wall mounting. Suitable for networks without harmonic distortion.

5

- Power Range: 17.5 to 200 kvar per cabinet
- Compact design in sheet steel or insulated enclosures
- Ready for connection
- Fully automatic and intelligent Power Factor Control Relay
- Power Factor Correction Capacitors LKT dry type with four safety features

Application Recommendations

Power Factor Correction Systems type LSK and LSKI are a perfect solution for small and medium-sized firms and buildings.

Power Factor Correction Systems type LSK /LSKI are suitable for power factor correction in networks without harmonic distortion.

Attention: Even low harmonic levels can be amplified by network resonances. High harmonic levels can overload or damage all electrical devices and machines in the network.

Today, networks without harmonic distortion are quite rare. Therefore we generally recommend installing fixed capacitors with Harmonic Filter Reactors (page 115 ff.).

Power Factor Correction Systems

Power Factor Correction Systems

Power Range

Power Factor Correction System in sheet steel cabinet:

- **LSK ...-4:** 17.5 to 60 kvar
- **LSK ...-2:** 68.75 to 100 kvar
- **LSK ...-3:** 112.5 to 200 kvar

Power Factor Correction System in insulation material housing:

- **LSKI ...-4:** 17.5 to 52.5 kvar

Construction

The ready-for-connection Power Factor Correction System consists of a pre-assembled mounting plate, type LSPN or LSP and suitable sheet steel or insulated enclosures.

The cabinet contains:

- Self-healing LKT type power capacitors with low-loss self-healing dielectric made from segmented metallised polypropylene film. Filled with a PCB-free filler. With discharge resistors, as per EN 60831-1 and -2 as well as IEC 60831-1 and -2
- Capacitor Switching Contactors with leading transition contact for damping of current peaks
- Fuse links, 3-pole, size NH00
- Control terminal strip with control fuse and thermal trip contact for safety shutdown
- Intelligent Power Factor Control of the PQC series

Installation Site

The place of installation must comply with the requirements of the ingress protection and ambient temperature concerned.

Regulations

For installation and connection of Power Factor Correction Capacitors in Germany the following regulations must be complied with: VDE 0100, VDE 0105, VDE 0560 Part 46 and VDE 0106 Part 100 (German Association of Electrical Engineers). In other countries the equivalent local regulations must be followed.

Connection

The power supply cable and the current transformer cable enter the bottom of the cabinet through a sliding gland plate and a cable clamp rail, the power supply being connected to the busbar system and the current transformer cable to the terminal strip provided.

System Expansion

An extension of the system is possible by adding LSKZ or LSKIZ extension units. This extension unit will be integrated in the existing control circuit via the control cable (supplied with the extension unit).

Technical Data

Design	LSK	Sheet steel wall cabinet
	LSKI	Insulated wall cabinet
	LSK/LSKI ...-4	with door left hinged
	LSK ...-2 / ...-3	with door right hinged

Rated voltage 400 V / 50 Hz

Rated voltage of capacitors 440 V / 50 Hz

Ambient temperature -5 °C to +35 °C

Humidity Max. 90 %, no condensation

Cabinet colour RAL 7035

Standards EN 60831-1 and -2
IEC 60831-1 and -2
EN 61921
IEC 61921
EN 61439-1 and -2
IEC 61439-1 and 2

Important Notes

The presence of inductive and capacitive reactances in the low voltage network means that the harmonics generated there, together with those fed in from the medium voltage network, can be amplified many times over due to resonance. Particularly in industrial networks with loads that generate harmonics, the use of conventional power factor correction systems without Harmonic Filter Reactors is not advisable. Instead, detuned systems should be installed. See the LSK-P series of Power Factor Correction Systems.

For further information on power factor correction and harmonics please refer to our "Manual of Power Factor Correction".

FRAKO systems are designed for connecting 5 core cables. If a 4-core cable is used, a jumper must be fitted to connect PE and N, or a control transformer must be installed.

Power Factor Correction Systems

Power Factor Correction Systems

Article- No.	Type	Rated power [kvar]	Stage power [kvar]	Switching sequence	Dimensions			Weight approx. [kg]	Protection IP
					Width [mm]	Height [mm]	Depth [mm]		

Power Factor Correction Systems in sheet steel wall cabinets, rated mains voltage: 400 V / 50 Hz

Type series: LSK ...-4

34-14819	LSK 17,5-2,5-111-400-4-620-54	17.5	2.5	1:2:4	500	500	300	26	54
34-14820	LSK 27,5-2,5-112-400-4-620-54	27.5	2.5	1:2:4:4	500	500	300	29	54
34-14821	LSK 30-5-11A-400-4-620-54	30	5	1:2:3	500	500	300	29	54
34-14822	LSK 37,5-2,5-1111-400-4-620-54	37.5	2.5	1:2:4:8	500	500	300	31	54
34-14823	LSK 37,5-7,5-12-400-4-620-54	37.5	7.5	1:2:2	500	500	300	29	54
34-14824	LSK 43,75-6,25-111-400-4-620-54	43.75	6.25	1:2:4	500	500	300	30	54
34-14836	LSK 46,88-3,13-1111-400-4-620-54	46.88	3.13	1:2:4:8	500	500	300	31	54
34-14837	LSK 50-5-11A1-400-4-620-54	50	5	1:2:3:4	500	500	300	32	54
34-14838	LSK 50-10-12-400-4-620-54	50	10	1:2:2	500	500	300	30	54
34-14839	LSK 52,5-7,5-111-400-4-620-54	52.5	7.5	1:2:4	500	500	300	31	54
34-14840	LSK 60-10-11A-400-4-620-54	60	10	1:2:3	500	500	300	33	54

Versions in enclosures made of insulating material (LSKI) available in ratings up to and including 52.5 kvar.

Power Factor Correction Systems in sheet steel wall cabinets, rated mains voltage: 400 V / 50 Hz

Type series: LSK ...-2

34-14841	LSK 68,75-6,25-112-400-2-620	68.75	6.25	1:2:4:4	600	811	286	43	20
34-14842	LSK 75-6,25-212-400-2-620	75	6.25	1:1:2:4:4	600	811	286	44	20
34-14843	LSK 75-12,5-11A-400-2-620	75	12.5	1:2:3	600	811	286	44	20
34-14844	LSK 87,5-12,5-111-400-2-620	87.5	12.5	1:2:4	600	811	286	45	20
34-14845	LSK 93,75-6,25-1111-400-2-620	93.75	6.25	1:2:4:8	600	811	286	46	20
34-14846	LSK 100-12,5-211-400-2-620	100	12.5	1:1:2:4	600	811	286	49	20

Power Factor Correction Systems, extension units in sheet steel wall cabinets, rated mains voltage: 400 V / 50 Hz

Type series: LSKZ ...-2

34-14080	LSKZ 50-50-1-400-2	50	50	1	600	811	286	42	20
34-14078	LSKZ 75-25-11-400-2	75	25	1:2	600	811	286	51	20
34-14076	LSKZ 100-50-2-400-2	100	50	1:1	600	811	286	55	20

Power Factor Correction System in sheet steel wall cabinets, rated mains voltage: 400 V / 50 Hz

Type series: LSK ...-3

34-14825	LSK 112,5-6,25-11AB-400-3-620	112.5	6.25	1:2:3:6:6	600	1211	311	88	20
34-14826	LSK 125-12,5-221-400-3-620	125	12.5	1:1:2:2:4	600	1211	311	88	20
34-14827	LSK 143,75-6,25-1112-400-3-620	143.75	6.25	1:2:4:8:8	600	1211	311	91	20
34-14847	LSK 150-12,5-212-400-3-620	150	12.5	1:1:2:4:4	600	1211	311	92	20
34-14828	LSK 150-25-22-400-3-620	150	25	1:1:2:2	600	1211	311	90	20
34-14848	LSK 175-25-13-400-3-620	175	25	1:2:2:2	600	1211	311	94	20
34-14849	LSK 187,5-12,5-113-400-3-620	187.5	12.5	1:2:4:4:4	600	1211	311	101	20
34-14850	LSK 200-12,5-213-400-3-620	200	12.5	1:1:2:4:4:4	500	1211	311	93	20
34-14851	LSK 200-25-23-400-3-620	200	25	1:1:2:2:2	600	1211	311	98	20

Power Factor Correction Systems, extension units in sheet steel wall cabinets, rated mains voltage: 400 V / 50 Hz

Type series: LSKZ ...-3

34-14054	LSKZ 150-50-3-400-3	150	50	1:1:1	600	1211	311	91	20
34-14074	LSKZ 200-50-4-400-3	200	50	1:1:1:1	600	1211	311	97	20

Power Factor Correction Systems

Power Factor Correction Systems

Options and accessories for Power Factor Correction Systems type LSK / LSKI 400V, 50 Hz

Options, mounted and wired ready for operation

Article-No.	Type	Description	LSKI ...-4	LSK ...-4	LSK ...-3	LSK ...-2
S34-5540	-650- (instead of -620)	Power Factor Control Relay PQC-12/1 instead of PQC-6/1	•	•	•	•
S34-5508	-Li	Cabinet with door left hinged			•	•
S34-0060	-SO	Special painting outside (RAL-Scale)		•	•	•
S34-5032	-54	Ingress protection IP 54			•	
S34-5511	-S131	Fuse switch disconnecter instead of fuse base per 50 kvar		1 pc.		2 pcs.
S34-5511	-S131	Fuse switch disconnecter instead of fuse base, power < 150 kvar			3 pcs.	
S34-5511	-S131	Fuse switch disconnecter instead of fuse base, power ≥ 150 kvar			4 pcs.	
S34-0103	-LSA	Switch disconnecter* three-pole, 160 A in cable entry compartment			•	
S34-5538	-LSA	Switch disconnecter* three-pole, 250 A in cable entry compartment, size of the cabinet changes for LSK...-3				•
S34-0105	-LSA	Switch disconnecter* three-pole, 400 A in cable entry compartment			•	
S34-0039	-S56	Control switch (On/Off) fitted and connected (requirement for power factor correction systems installed in Switzerland)	•	•	•	•
S34-5535	-S19	Control phase + N via a protective motor switch (option for France)	•	•	•	•
S34-5537	-S119 (+ Power)	Control transformer set 315 VA incl. primary and secondary fuses	•	•	•	•
S34-5073	-SO (+ Description)	Voltage meter with switch	•	•	•	•
S34-0040	-S66	Summation current transformer 5+5/5A	•	•	•	•
S34-0081	-S66	Summation current transformer 5+5+5/5A	•	•	•	•

*) Switch disconnecter can be operated from the outside

Accessories

Article-No.	Type	Description	LSKI ...-4	LSK ...-4	LSK ...-3	LSK ...-2
34-80021	WB LSK-10	Wall distance assembly set 10 mm		•	•	•
34-80018	WB LSK-40	Wall distance assembly set 40 mm		•	•	•
34-80196	KR-LSK-2/LKND/ LKNS-200-RIT	Floor standing base (Height = 200 mm; Depth = 270 mm)				•
34-80194	KR-LSK-3-200	Floor standing base (Height = 200 mm; Depth = 300 mm)			•	

Power Factor Correction Systems

Power Factor Correction Systems

Dimensions

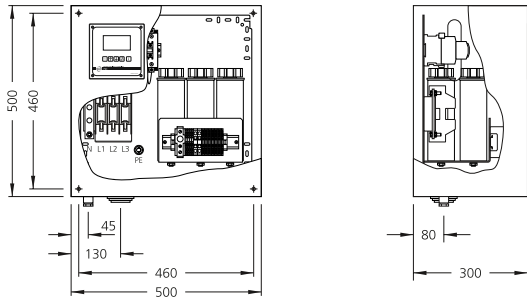

Dimensional drawing LSK-4 (17.5 to 60 kvar)

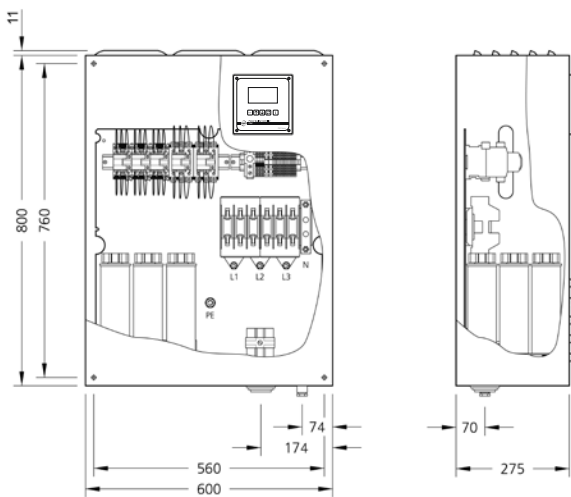

Dimensional drawing LSK-2 (68.75 to 100 kvar)

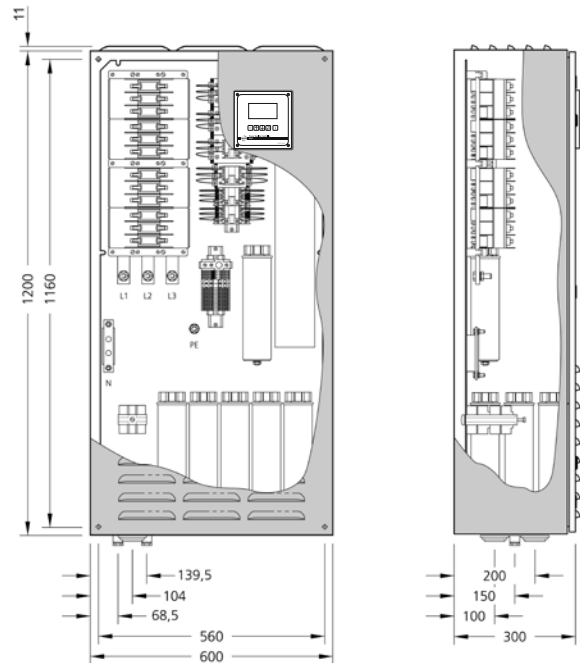

Dimensional drawing LSK-3 (112.5 to 200 kvar)

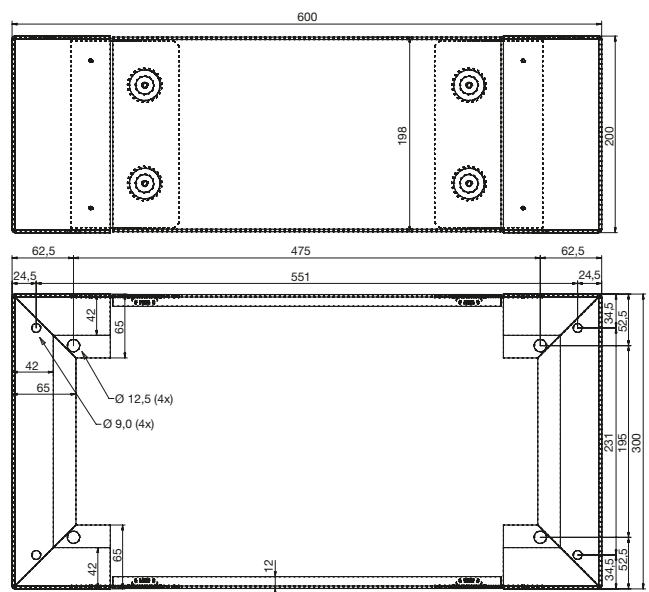

Dimensional drawing base LSK-3

All dimensions in mm



Power Factor Correction Systems

Power Factor Correction Systems

5



Power Factor Correction Systems

Power Factor Correction Systems



LSFC Power Factor Correction Systems

Ready to connect, automatic Power Factor Correction Systems in sheet steel cabinets for floor installation. Suitable for networks without harmonic distortion.

- Power Range: 100 to 500 kvar
- Modular construction in freestanding sheet steel cabinet
- Ready for connection
- Fully automatic and intelligent Power Factor Control Relay
- Power Factor Correction Capacitors LKT dry-type with four safety features

Application Recommendations

Power Factor Correction Systems, type LSFC are suitable for compensation in networks without harmonic distortion.

Attention: Even low harmonic levels can be amplified by network resonances. For Power Factor Correction Systems with a power >150 kvar this effect will amplify even more. This is because the PFC-System, together with the transformer, generates resonance frequencies in the network, which are within the range of the low frequency, energy-intensive harmonics. High harmonic levels can overload or damage all electrical devices and machines in the network.

Today, networks without harmonic distortion are quite rare. Therefore we generally recommend installing fixed capacitors with Harmonic Filter Reactors (page 115 ff.).

Power Factor Correction Systems

Power Factor Correction Systems

Power Range

Power Factor Correction System in sheet steel cabinet:

- 100 to 500 kvar

Construction

The ready-for-connection Power Factor Correction System consists of pre-assembled capacitor-reactor modules type C64C... and the suitable sheet steel cabinet.

The cabinet contains:

- Self-healing LKT type power capacitors with low loss self-healing dielectric made from segmented metallised polypropylene film. Filled with a PCB-free filler. With discharge resistors, as per EN 60831-1 and -2 as well as IEC 60831-1 and -2
- Capacitor Switching Contactors with leading transition contact for damping of current peaks
- Fuse links, 3-pole, size NH00
- Control terminal strip with control fuse and thermal trip contact for safety shutdown
- Intelligent Power Factor Control Relay of the PQC series

Application / Installation

The place of installation must comply with the requirements of the ingress protection and ambient temperature concerned.

Regulations

For installation and connection of Power Factor Correction Capacitors in Germany the following regulations must be complied with: VDE 0100, VDE 0105, VDE 0560 Part 46 and VDE 0106 Part 100 (German Association of Electrical Engineers). In other countries the equivalent local regulations must be followed.

Connection

The power supply cable and the current transformer cable enter the bottom of the cabinet through a sliding gland plate and a cable clamp rail, the power supply being connected to the busbar system and the current transformer cable to the terminal strip provided.

System Expansion

An extension of the system is possible by adding LSFCZ extension units. This extension unit will be integrated in the existing control circuit via the control cable (supplied with the extension unit).

Technical Data

Design	Sheet steel cabinet with door right hinged
Rated voltage	400 V / 50 Hz
Rated voltage of capacitors	440 V / 50 Hz
Ambient temperature	-5 °C to +40 °C
Humidity	Max. 90 %, no condensation
Cabinet colour	RAL 7035
Standards	EN 60831-1 and -2 IEC 60831-1 and -2 EN 61921 IEC 61921 EN 61439-1 and -2 IEC 61439-1 and 2

Important Notes

The presence of inductive and capacitive reactances in the low voltage network means that the harmonics generated there, together with those fed in from the medium voltage network, can be amplified many times over due to resonance. Particularly in industrial networks with loads that generate harmonics, the use of conventional power factor correction systems without Harmonic Filter Reactors is not advisable. Instead, detuned systems should be installed. See the LSFC-P series of Power Factor Correction Systems.

For further information on power factor correction and harmonics please refer to our "Manual of Power Factor Correction".

FRAKO systems are designed for connecting 5 core cables. If a 4-core cable is used, a jumper must be fitted to connect PE and N, or a control transformer must be installed.

Power Factor Correction Systems

Power Factor Correction Systems

Article- No.	Type	Rated power	Stage power	Switching sequence	Dimensions			Weight approx. [kg]	Protection IP
		[kvar]	[kvar]		Width [mm]	Height [mm]	Depth [mm]		

Power Factor Correction Systems in sheet steel cabinets (width = 600 mm), rated mains voltage: 400 V / 50 Hz

Type series: LSFC

34-22773	LSFC 100-12,5-211-400-64-620	100	12.5	1:1:2:4	600	2000	400	120.5	30
34-22774	LSFC 100-25-21-400-64-620	100	25	1:1:2	600	2000	400	116	30
34-22775	LSFC 125-12,5-221-400-64-620	125	12.5	1:1:2:2:4	600	2000	400	136	30
34-22776	LSFC 125-25-12-400-64-620	125	25	1:2:2	600	2000	400	132	30
34-22777	LSFC 150-12,5-212-400-64-620	150	12.5	1:1:2:4:4	600	2000	400	137	30
34-22778	LSFC 150-25-22-400-64-620	150	25	1:1:2:2	600	2000	400	135	30
34-22779	LSFC 150-25-6-400-64-620	150	25	1:1:1:1:1:1	600	2000	400	136	30
34-22780	LSFC 175-12,5-11A2-400-64-620	175	12.5	1:2:3:4:4	600	2000	400	139	30
34-22781	LSFC 175-25-13-400-64-620	175	25	1:2:2:2	600	2000	400	138	30
34-22782	LSFC 200-12,5-213-400-64-620	200	12.5	1:1:2:4:4:4	600	2000	400	141	30
34-22783	LSFC 200-25-23-400-64-620	200	25	1:1:2:2:2	600	2000	400	143	30
34-22784	LSFC 200-25-8-400-64-650	200	25	1:1:1:1:1:1:1:1	600	2000	400	149	30
34-22785	LSFC 225-12,5-223-400-64-650	225	12.5	1:1:2:2:4:4:4	600	2000	400	156	30
34-22786	LSFC 225-25-14-400-64-620	225	25	1:2:2:2:2	600	2000	400	152	30
34-22787	LSFC 225-25-9-400-64-650	225	25	1:1:2:4:4:4:4	600	2000	400	154	30
34-22788	LSFC 250-12,5-214-400-64-650	250	12.5	1:1:2:4:4:4:4	600	2000	400	158	30
34-22789	LSFC 250-25-24-400-64-620	250	25	1:1:2:2:2:2	600	2000	400	157	30
34-22790	LSFC 250-25-0-400-64-650	250	25	1:1:1:1:1:1:1:1:1:1	600	2000	400	159	30
34-22791	LSFC 250-50-5-400-64-620	250	50	1:1:1:1:1	600	2100	400	156	30
34-22792	LSFC 275-25-15-400-64-620	275	25	1:2:2:2:2:2	600	2000	400	166	30
34-22793	LSFC 300-12,5-215-400-64-650	300	12.5	1:1:2:4:4:4:4:4	600	2000	400	166	30
34-22794	LSFC 300-25-25-400-64-650	300	25	1:1:2:2:2:2:2	600	2000	400	163	30
34-22795	LSFC 300-25-0-400-64-650	300	25	1:1:1:1:1:1:1:1:1:1:1	600	2000	400	236	30
34-22796	LSFC 300-50-6-400-64-620	300	50	1:1:1:1:1:1	600	2000	400	164	30
34-22797	LSFC 325-25-16-400-64-650	325	25	1:2:2:2:2:2:2	600	2000	400	174	20
34-22798	LSFC 350-25-26-400-64-650	350	25	1:1:2:2:2:2:2:2	600	2000	400	183	20
34-22799	LSFC 350-50-7-400-64-650	350	50	1:1:1:1:1:1:1	600	2000	400	181	20
34-22800	LSFC 375-25-17-400-64-650	375	25	1:2:2:2:2:2:2:2	600	2000	400	190	20
34-22801	LSFC 400-25-27-400-64-650	400	25	1:1:2:2:2:2:2:2:2	600	2000	400	188	20
34-22802	LSFC 400-50-8-400-64-650	400	50	1:1:1:1:1:1:1:1	600	2000	400	173	20

Power Factor Correction Systems, extension units in sheet steel cabinets (width = 600 mm), rated mains voltage: 400 V / 50 Hz

Type series: LSFCZ

34-16235	LSFCZ 100-50-2-400-64	100	50	1:1	600	2000	400	137	30
34-16236	LSFCZ 150-50-3-400-64	150	50	1:1:1	600	2000	400	125	30
34-16237	LSFCZ 200-50-4-400-64	200	50	1:1:1:1	600	2000	400	142	30
34-16238	LSFCZ 250-50-5-400-64	250	50	1:1:1:1:1	600	2000	400	157	30
34-16239	LSFCZ 300-50-6-400-64	300	50	1:1:1:1:1:1	600	2000	400	180	30
34-16240	LSFCZ 350-50-7-400-64	350	50	1:1:1:1:1:1:1	600	2000	400	183	20
34-16241	LSFCZ 400-50-8-400-64	400	50	1:1:1:1:1:1:1:1	600	2000	400	185	20

Other rated voltages, frequencies and power ratings on request.

Recommended supply lead cross sections: please refer to the technical annex (page 137 ff.).

Systems > 300 kvar with internal roof vent

Power Factor Correction Systems

Power Factor Correction Systems

Options and accessories for Power Factor Correction Systems type LSFC 400 V, 50 Hz

Options, mounted and wired ready for operation

Article-No.	Type	Description	for System type
S34-5540	-650- (instead of -620)	Power Factor Control Relay PQC-12/1 instead of PQC-6/1	all
S34-5519	-66- (instead of -64-)	FRAKO LSFC-66 WxHxD: 600x2000x600 mm (without floor standing base and roof)	LSFC-64
S34-5528	-66- (instead of -84-)	FRAKO LSFC-66 WxHxD: 600x2000x600 mm (without floor standing base and roof)	LSFC-84
S34-5503	-84- (instead of -64-)	FRAKO LSFC-84 WxHxD: 800x2000x400 mm (without floor standing base and roof)	LSFC-64
S34-5524	-85- (instead of -84-)	FRAKO LSFC-85 WxHxD: 800x2000x500 mm (without floor standing base and roof)	LSFC-84
S34-5517	-86- (instead of -84/85-)	FRAKO LSFC-86 WxHxD: 800x2000x600 mm (without floor standing base and roof)	LSFC-84/-85
S34-5554	-119- (instead of -64-)	Rittal VX 8604, WxHxD: 600x2000x400 mm (without floor standing base and roof)	LSFC-64
S34-5555	-118- (instead of -84/85-)	Rittal VX 8606 WxHxD: 600x2000x600 mm (without floor standing base and roof)	LSFC-84/-85
S34-5556	-117- (instead of -84-)	Rittal VX 8804, WxHxD: 800x2000x400 mm (without floor standing base and roof)	LSFC-84
S34-5557	-116- (instead of -85-)	Rittal VX 8805, WxHxD: 800x2000x500 mm (without floor standing base and roof)	LSFC-85
S34-5558	-115- (instead of -84-)	Rittal VX 8806, WxHxD: 800x2000x600 mm (without floor standing base and roof)	LSFC-84
S34-5559	-115- (instead of -85-)	Rittal VX 8806, WxHxD: 800x2000x600 mm (without floor standing base and roof)	LSFC-85
S34-5509	-Li	Cabinet door with door left hinged	all type FRAKO LSFC
S34-5510	-Li	Cabinet door with door left hinged	all type Rittal VX
S34-5023	-S60	Pivoting lever closure for mounting a semiprofile cylinder	all
S34-0060	-SO (+ Description)	Special painting outside (RAL-Scale)	all
S34-0010	-S1	Cable entry through the cabinet roof with connection on top	up to 400 kvar/cabinet
S34-5512	-54	Ingress protection IP54	≤ 300 kvar/cabinet
S34-5513	-54	Ingress protection IP54	> 300 ≤ 400 kvar/cabinet
S34-0054	-S80	Ingress protection IPX1 with dust cover roof W x H x D: 520 x 300 x 50 mm; RAL 7035	all FRAKO LSFC
S34-5523	-S572	Ingress protection IP41, roof vent installation on cabinet instead of a roof vent installation in cabinet	≤ 400 kvar/cabinet
S34-5511	-S131	Fuse switch disconnecter instead of fuse base per 50 kvar	all
S34-5514	-SLTA	Fuse switch disconnecter in cable entry compartment	≤ 200 kvar/cabinet
S34-5515	-SLTA	Fuse switch disconnecter in cable entry compartment	≤ 300 kvar/cabinet
S34-0109	-LSA	Switch disconnecter* three-pole, 400 A in cable entry compartment, for cabinet width 600 mm	≤ 200 kvar/cabinet
S34-0108	-LSA	Switch disconnecter* three-pole, 400 A in cable entry compartment, for cabinet width 800 mm	≤ 200 kvar/cabinet
S34-0107	-LSA	Switch disconnecter* three-pole, 630 A in cable entry compartment, for cabinet width 600 mm	≤ 300 kvar/cabinet
S34-0106	-LSA	Switch disconnecter* three-pole, 630 A in cable entry compartment, for cabinet width 800 mm	≤ 300 kvar/cabinet
S34-0039	-S56	Control switch (On/Off) fitted and connected (requirement for power factor correction systems installed in Switzerland)	all

Power Factor Correction Systems

Power Factor Correction Systems

Article-No.	Type	Description	for System type
S34-5535	-S19	Control phase + N via a protective motor switch (option for France)	all
S34-5536	-S119	Control transformer set 500 VA incl. primary and secondary fuses	≤ 500 kvar
S34-5526	-S119	Control transformer set 800 VA incl. primary and secondary fuses	> 500 ≤ 900 kvar
S34-5069	-S53	3 ammeter incl. current transformer	all
S34-5073	-SO (+ Description)	Voltage meter with switch	all
S34-5077	-SO (+ Description)	kvar-Meter incl. current transformer; measuring range up to 300 kvar, 400 V	all
S34-5057	-SO (+ Description)	Measuring transducer 4-20 mA for power factor	all
S34-0040	-S66	Summation current transformer 5+5/5A	all
S34-0081	-S66	Summation current transformer 5+5+5/5A	all
S34-5049	-S145	Switch cabinet lighting with power outlet and position switch	all

*) Switch disconnecter can be operated from the outside

Accessories

Article-No.	Type	Description	Dimensions (W x D) in mm	for System type
34-80090	KR-LSFC-64-100	Floor standing base (h = 100 mm)	600 x 400	LSFC-64
34-80175	KR-LSFC-64-200	Floor standing base (h = 200 mm)	600 x 400	LSFC-64
34-80122	KR-LSFC-66-100	Floor standing base (h = 100 mm)	600 x 600	LSFC-66
34-80125	KR-LSFC-66-200	Floor standing base (h = 200 mm)	600 x 600	LSFC-66
34-80091	KR-LSFC-84-100	Floor standing base (h = 100 mm)	800 x 400	LSFC-84
34-80113	KR-LSFC-84-200	Floor standing base (h = 200 mm)	800 x 400	LSFC-84
34-80079	KR-LSFC-85-100	Floor standing base (h = 100 mm)	800 x 500	LSFC-85
34-80075	KR-LSFC-85-200	Floor standing base (h = 200 mm)	800 x 500	LSFC-85
34-80092	KR-LSFC-86-100	Floor standing base (h = 100 mm)	800 x 600	LSFC-86
34-80112	KR-LSFC-86-200	Floor standing base (h = 200 mm)	800 x 600	LSFC-86

Other options and accessories on request.

For dimensional drawings please see next page.

Dimensions

Power Factor Correction Systems

Power Factor Correction Systems

Base/plinth system VX

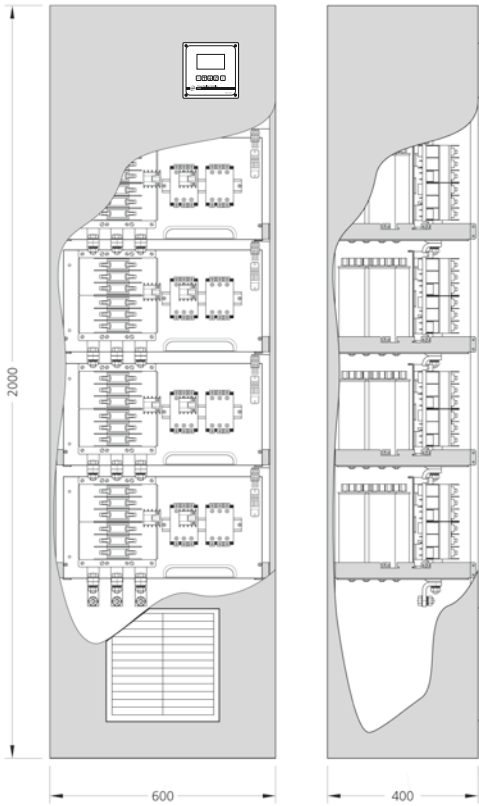

Dimensional drawing LSFC (100 bis 400 kvar)

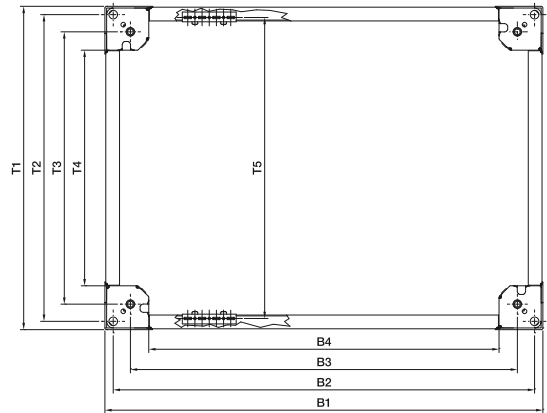

Dimensional drawing base/plinth 100 mm high

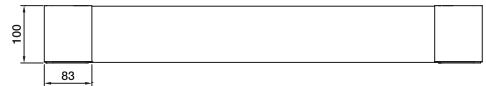

Dimensional drawing base/plinth 200 mm high

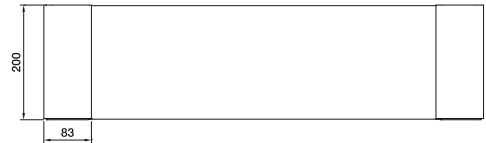

Base/plinth trim panels, solid, 100 mm high, front view

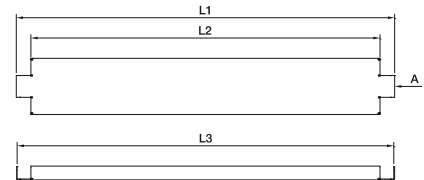

Base/plinth trim panels, solid, 200 mm high, front view

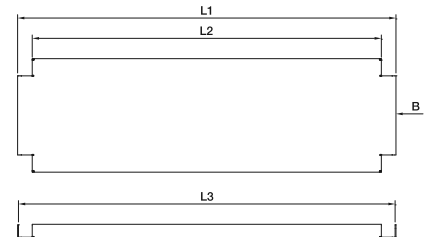

Description of the hole pattern

B1/T1 = outer dimensions

B2/T2 = for screwing with the corner piece of the cabinet (from below)

B3/T3 = for screwing to the cabinet bottom with a captive nut (from below or above)

For fixing to the floor, drill holes B2-B4/T2-T3 can be used.

For enclosure width or depth mm	Width dimensions mm				Length dimensions mm			Depth dimensions mm				
	B1	B2	B3	B4	L1	L2	L3	T1	T2	T3	T4	T5 ¹⁾
400	366	335	275	211	260	209	257	364	335	275	211	325
500	466	435	375	311	360	309	357	464	435	375	311	425
600	566	535	475	411	460	409	457	564	535	475	411	525
800	766	735	675	611	660	609	657	764	735	675	611	725

¹⁾ T5 = Distance between system punchings including base/plinth installation bracket

All dimensions in mm

Power Factor Correction Systems



Power Factor Correction Systems – detuned



Power Factor Correction Systems – detuned

Ready to connect, automatic Power Factor Correction Systems in sheet steel cabinets for wall mounting or floor installation. Detuned – for low-voltage networks with harmonic content.

5

	LSK-P	LSFC-P
		
Sheet steel cabinet for wall-mounting	•	-
Sheet steel cabinet for floor installation	-	•
System design	Compact	Modular
Power range up to [kvar]	100	500
With Power Factor Control Relay	•	•
Connection option from below	•	•
Connection option from top (optional)	-	•
Version (P...)	P7 / P8 / P1	P7 / P8 / P1
Extension unit	LSKZ-P	LSFCZ-P...
Catalogue page	Page 117 ff.	Page 123 ff.

Power Factor Correction Systems

Power Factor Correction Systems – detuned

5



Power Factor Correction Systems

Power Factor Correction Systems – detuned



LSK-P

Power Factor Correction Systems – detuned

Ready to connect, automatic Power Factor Correction Systems in sheet steel cabinets for wall mounting. Detuned – for low-voltage networks with harmonic content.

- Power Range: 17.5 to 100 kvar
- Compact design in sheet steel cabinet for wall-mounting
- Ready for connection
- Fully automatic and intelligent Power Factor Control Relay
- Power Factor Correction Capacitors LKT dry-type with four safety features

Application Recommendations

Power Factor Correction Systems type LSK-P are a perfect solution for small and medium-sized firms and buildings and also for power factor correction at sub-distribution boards.

They are suitable for supply networks with harmonic distortion according to EN 61000-2-4 class 2. They are available as follows:

Version	Detuning factor	Resonance frequency
P1	$p = 14 \%$	134 Hz
P7	$p = 7 \%$	189 Hz
P8	$p = 8 \%$	177 Hz

Power Factor Correction Systems

Power Factor Correction Systems – detuned

Power Range

Power Factor Correction System in sheet steel cabinet:

- 17.5 to 100 kvar

Construction

The ready-for-connection Power Factor Correction System consists of a pre-assembled mounting plate, type LSP-P and the suitable sheet steel cabinet.

The LSK-P contains:

- Self-healing LKT type power capacitors with low-loss self-healing dielectric made from segmented metallised polypropylene film. Filled with a PCB-free filler. With discharge resistors, as per EN 60831-1 and -2 as well as IEC 60831-1 and -2
- Heavy duty Capacitor Switching Contactors
- Harmonic Filter Reactors with overtemperature switch
- Fuse links, 3-pole, size NH00
- Control terminal strip with control fuse and thermal trip contact for safety shutdown
- Intelligent Power Factor Control Relay of the PQC series

Installation Site

The place of installation must comply with the requirements of the ingress protection and ambient temperature concerned.

Regulations

For installation and connection of Power Factor Correction Capacitors in Germany the following regulations must be complied with: VDE 0100, VDE 0105, VDE 0560 Part 46 and VDE 0106 Part 100 (German Association of Electrical Engineers). In other countries the equivalent local regulations must be followed.

Connection

The power cable and the CT cable enter the bottom of the cabinet through cable glands or rubber sleeves. The power cable is connected directly to the NH fuse base, the cable from the current transformer to the terminal strip.

System Expansion

An extension of the system is possible by adding LSKZ-P extension units. This extension unit will be integrated in the existing control circuit via the control cable (supplied with the extension unit).

Technical Data

Design	Sheet steel wall cabinet with door right hinged
Rated voltage	400 V/50 Hz
Rated voltage of capacitors	440 V/50 Hz
Ambient temperature	-5 °C to +35 °C
Humidity	Max. 90 %, no condensation
Cabinet colour	RAL 7035
Standards	EN 60831-1 and -2 IEC 60831-1 and -2 EN 61921 IEC 61921 EN 61439-1 and -2 IEC 61439-1 and 2

Important Notes

For further information on power factor correction and harmonics please refer to our "Manual of Power Factor Correction".

FRAKO systems are designed for connecting 5 core cables. If a 4-core cable is used, a jumper must be fitted to connect PE and N, or a control transformer must be installed.

Power Factor Correction Systems

Power Factor Correction Systems – detuned

Version: P1 (Detuning factor $p = 14\%$)

Article- No.	Type	Rated power [kvar]	Stage power [kvar]	Switching sequence	Dimensions			Weight approx. [kg]	Protection IP
					Width [mm]	Height [mm]	Depth [mm]		

Power Factor Correction Systems in sheet steel wall cabinets, rated mains voltage: 400 V / 50 Hz

Type series: LSK ...-3-P1

34-14566	LSK 21,88-3,13-111-400-3-620-P1	21.88	3.13	1:2:4	600	1211	311	97	20
34-14567	LSK 25-6,25-21-400-3-620-P1	25	6.25	1:1:2	600	1211	311	102	20
34-14568	LSK 31,25-6,25-12-400-3-620-P1	31.25	6.25	1:2:2	600	1211	311	105	20
34-14569	LSK 34,38-3,13-112-400-3-620-P1	34.38	3.13	1:2:4:4	600	1211	311	109	20
34-14570	LSK 43,75-6,25-111-400-3-620-P1	43.75	6.25	1:2:4	600	1211	311	119	20
34-14571	LSK 46,88-3,13-1111-400-3-620-P1	46.88	3.13	1:2:4:8	600	1211	311	125	20
34-14572	LSK 50-6,25-211-400-3-620-P1	50	6.25	1:1:2:4	600	1211	311	130	20
34-14573	LSK 50-12,5-21-400-3-620-P1	50	12.5	1:1:2	600	1211	311	125	20
34-14575	LSK 62,5-12,5-12-400-3-620-P1	62.5	12.5	1:2:2	600	1211	311	138	20
34-14576	LSK 68,75-6,25-112-400-3-620-P1	68.75	6.25	1:2:4:4	600	1211	311	150	20
34-14577	LSK 75-12,5-11A-400-3-620-P1	75	12.5	1:2:3	600	1211	311	157	20
34-14578	LSK 75-12,5-22-400-3-620-P1	75	12.5	1:1:2:2	600	1211	311	153	20
34-14579	LSK 75-25-11-400-3-620-P1	75	25	1:2	600	1211	311	151	20
34-14580	LSK 87,5-12,5-111-400-3-620-P1	87.5	12.5	1:2:4	600	1211	311	159	20
34-14581	LSK 100-16,67-11A-400-3-620-P1	100	16.67	1:2:3	600	1211	311	170	20

Power Factor Correction Systems, extension units in sheet steel wall cabinets, rated mains voltage: 400 V / 50 Hz

Type series: LSKZ ...-3-P1

34-14121	LSKZ 50-50-1-400-3-P1	50	50	1	600	1211	311	119	20
34-14131	LSKZ 75-25-11-400-3-P1	75	25	1:2	600	1211	311	150	20

Other rated voltages, frequencies and power ratings on request.

Recommended supply lead cross sections: please refer to the technical annex (page 137 ff.).

Power Factor Correction Systems

Power Factor Correction Systems – detuned

Version: P7 (Detuning factor $p = 7\%$)

Article- No.	Type	Rated power [kvar]	Stage power [kvar]	Switching sequence	Dimensions			Weight approx. [kg]	Protection IP
					Width [mm]	Height [mm]	Depth [mm]		

Power Factor Correction Systems in sheet steel wall cabinets, rated mains voltage: 400 V / 50 Hz

Type series: LSK ...-3-P7

34-14582	LSK 17,5-2,5-111-400-3-620-P7	17.5	2.5	1:2:4	600	1211	311	85	20
34-14583	LSK 25-5-12-400-3-620-P7	25	5	1:2:2	600	1211	311	91	20
34-14584	LSK 25-6,25-21-400-3-620-P7	25	6.25	1:1:2	600	1211	311	87	20
34-14585	LSK 30-5-11A-400-3-620-P7	30	5	1:2:3	600	1211	311	94	20
34-14586	LSK 31,25-6,25-12-400-3-620-P7	31.25	6.25	1:2:2	600	1211	311	92	20
34-14587	LSK 43,75-6,25-111-400-3-620-P7	43.75	6.25	1:2:4	600	1211	311	97	20
34-14588	LSK 46,88-3,13-1111-400-3-620-P7	46.88	3.13	1:2:4:8	600	1211	311	102	20
34-14589	LSK 50-6,25-211-400-3-620-P7	50	6.25	1:1:2:4	600	1211	311	104	20
34-14590	LSK 50-12,5-21-400-3-620-P7	50	12.5	1:1:2	600	1211	311	100	20
34-14592	LSK 52,5-7,5-111-400-3-620-P7	52.5	7.5	1:2:4	600	1211	311	107	20
34-14593	LSK 60-10-11A-400-3-620-P7	60	10	1:2:3	600	1211	311	111	20
34-14594	LSK 62,5-12,5-12-400-3-620-P7	62.5	12.5	1:2:2	600	1211	311	107	20
34-14595	LSK 68,75-6,25-112-400-3-620-P7	68.75	6.25	1:2:4:4	600	1211	311	117	20
34-14596	LSK 75-12,5-11A-400-3-620-P7	75	12.5	1:2:3	600	1211	311	117	20
34-14597	LSK 75-12,5-22-400-3-620-P7	75	12.5	1:1:2:2	600	1211	311	122	20
34-14598	LSK 75-25-11-400-3-620-P7	75	25	1:2	600	1211	311	112	20
34-14599	LSK 87,5-12,5-111-400-3-620-P7	87.5	12.5	1:2:4	600	1211	311	122	20
34-14600	LSK 93,75-6,25-1111-400-3-620-P7	93.75	6.25	1:2:4:8	600	1211	311	131	20
34-14601	LSK 100-12,5-211-400-3-620-P7	100	12.5	1:1:2:4	600	1211	311	134	20
34-14602	LSK 100-16,67-11A-400-3-620-P7	100	16.67	1:2:3	600	1211	311	135	20
34-14603	LSK 100-25-21-400-3-620-P7	100	25	1:1:2	600	1211	311	129	20

Power Factor Correction Systems, extension units in sheet steel wall cabinets, rated mains voltage: 400 V / 50 Hz

Type series: LSKZ ...-3-P7

34-14127	LSKZ 50-50-1-400-3-P7	50	50	1	600	1211	311	100	20
34-14128	LSKZ 60-30-2-400-3-P7	60	30	1:1	600	1211	311	109	20
34-14120	LSKZ 75-25-11-400-3-P7	75	25	1:2	600	1211	311	113	20
34-14129	LSKZ 90-30-3-400-3-P7	90	30	1:1:1	600	1211	311	115	20
34-14130	LSKZ 100-50-2-400-3-P7	100	50	1:1	600	1211	311	120	20

Versions with an 8 % choke factor are available with the same corrective power and configuration of the capacitance stages.

Other rated voltages, frequencies and power ratings on request.

Recommended supply lead cross sections: please refer to the technical annex (page 137 ff.).

Power Factor Correction Systems

Power Factor Correction Systems – detuned

Options and accessories for Power Factor Correction Systems type LSK-P 400V, 50 Hz

Article-No.	Type	Description
Options, mounted and wired ready for operation		
S34-5540	-650- (instead of -620)	Power Factor Control Relay PQC-12/1 instead of PQC-6/1
S34-5508	-Li	Cabinet door with door left hinged
S34-0060	-SO	Special painting outside (RAL-Scale)
S34-5032	-54	Ingress protection IP54
S34-5511	-S131	With connection at the top instead of fuse base ≤ 60 kvar = 1 pc. > 60 kvar = 2 pcs
S34-0103	-LSA	Switch disconnecter* three-pole, 160 A in cable entry compartment ≤ 60 kvar
S34-0104	-LSA	Switch disconnecter* three-pole, 250 A in cable entry compartment > 60 kvar
S34-0039	-S56	Control switch (On/Off) fitted and connected (requirement for power factor correction systems installed in Switzerland)
S34-5535	-S19	Control phase + N via a protective motor switch (option for France)
S34-5537	-S119 (+ Power)	Control transformer set 315 VA incl. primary and secondary fuses
S34-5073	-SO (+ Description)	Voltage meter with switch
S34-0040	-S66	Summation current transformer 5+5/5A
S34-0081	-S66	Summation current transformer 5+5+5/5A
Accessories, loose		
34-80021	WB LSK-10	Wall distance assembly set 10 mm
34-80018	WB LSK-40	Wall distance assembly set 40 mm
34-80194	KR-LSK-3-200	Fixed base (Height = 200 mm; Depth = 300 mm)

*) Switch disconnecter can be operated from the outside
Other options and accessories on request

Dimensions

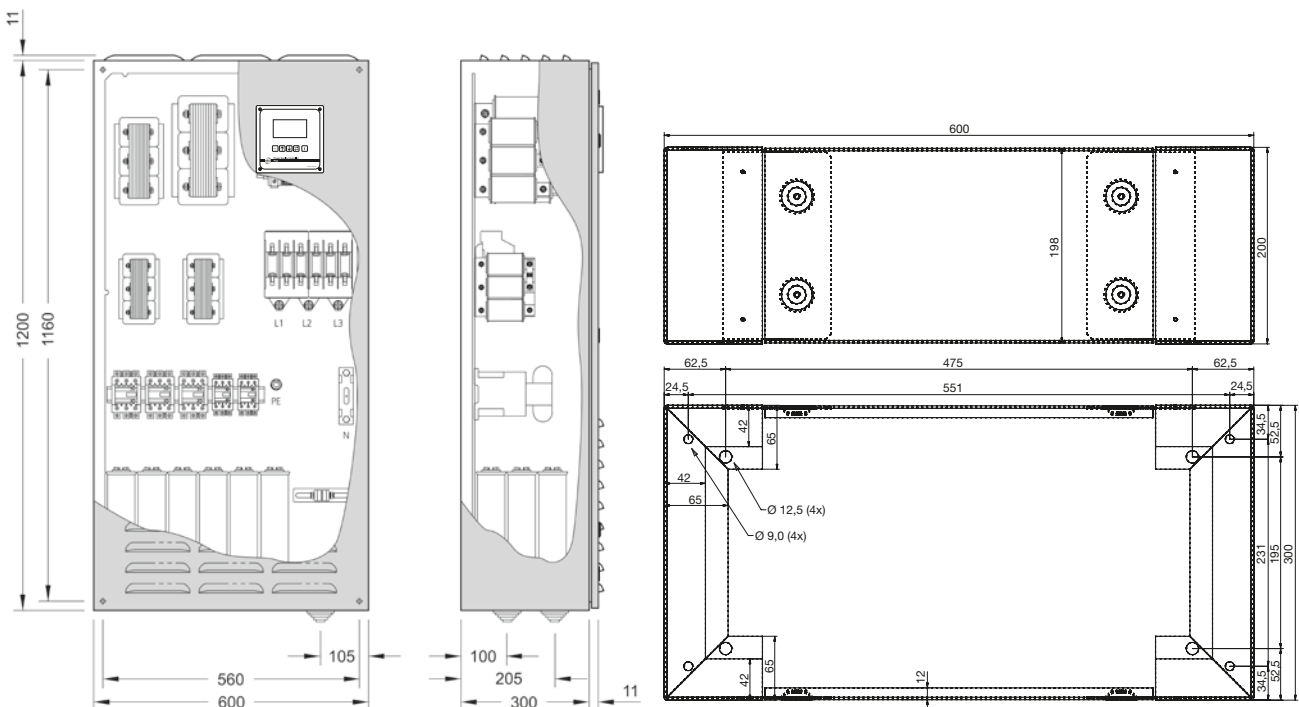

Dimensional drawing LSK-P (17.5 bis 100 kvar)

Dimensional drawing base LSK-3

All dimensions in mm

Power Factor Correction Systems

Power Factor Correction Systems – detuned

5



Power Factor Correction Systems

Power Factor Correction Systems – detuned



LSFC-P

Power Factor Correction Systems – detuned

Ready to connect, automatic Power Factor Correction Systems in sheet steel cabinets for floor installation. Detuned – for low-voltage networks with harmonic content.

- Power Range: 75 to 500 kvar
- Modular construction in freestanding sheet steel cabinet
- Ready for connection
- Fully automatic and intelligent Power Factor Control Relay
- Power Factor Correction Capacitors LKT dry-type with four safety features

Application Recommendations

Power Factor Correction Systems, type LSFC-P are suitable for compensation in networks with harmonic distortion according to EN 61000-2-4 class 2.

They are available as follows:

Version	Detuning factor	Resonance frequency
P1	$\rho = 14 \%$	134 Hz
P7	$\rho = 7 \%$	189 Hz
P8	$\rho = 8 \%$	177 Hz
P5	$\rho = 5.67 \%$	210 Hz

Power Factor Correction Systems

Power Factor Correction Systems – detuned

Power Range

Power Factor Correction System in sheet steel cabinet:

- 75 to 500 kvar

Design

The ready-for-connection Power Factor Correction System consists of pre-assembled capacitor-reactor modules, type C6XD... or C8XD... and the suitable sheet steel cabinet.

The cabinet contains:

- Self-healing LKT type power capacitors with low-loss self-healing dielectric made from segmented metallised polypropylene film. Filled with a PCB-free filler. With discharge resistors, as per EN 60831-1 and -2 as well as IEC 60831-1 and -2
- Heavy duty Capacitor Switching Contactors
- Harmonic Filter Reactors with overtemperature switch
- Fuse links, 3-pole, size NH00
- Control terminal strip with control fuse and thermal trip contact for safety shutdown
- Intelligent Power Factor Control Relay of the PQC series
- Thermostatically controlled motor fan

Installation Site

The place of installation must comply with the requirements of the ingress protection and ambient temperature concerned.

Regulations

For installation and connection of Power Factor Correction Capacitors in Germany the following regulations must be complied with: VDE 0100, VDE 0105, VDE 0560 Part 46 and VDE 0106 Part 100 (German Association of Electrical Engineers). In other countries the equivalent local regulations must be followed.

Connection

The power supply cable and the current transformer cable enter the bottom of the cabinet through a sliding gland plate and a cable clamp rail, the power supply being connected to the busbar system and the current transformer cable to the terminal strip provided.

System Expansion

An extension of the system is possible by adding LSFCZ-P extension units. This extension unit will be integrated in the existing control circuit via the control cable (supplied with the extension unit).

Technical Data

Design	Sheet steel cabinet with door right hinged
Rated voltage	400 V/50 Hz
Rated voltage of capacitors	440 V/50 Hz
Ambient temperature	-5 °C to +40 °C
Humidity	Max. 90 %, no condensation
Cabinet colour	RAL 7035
Standards	EN 60831-1 and -2 IEC 60831-1 and -2 EN 61921 IEC 61921 EN 61439-1 and -2 IEC 61439-1 and 2

Important Notes

For further information on power factor correction and harmonics please refer to our "Manual of Power Factor Correction".

FRAKO systems are designed for connecting 5 core cables. If a 4-core cable is used, a jumper must be fitted to connect PE and N, or a control transformer must be installed.

Power Factor Correction Systems

Power Factor Correction Systems – detuned

Version: P1 (Detuning factor p = 14 %)

Article- No.	Type	Rated power [kvar]	Stage power [kvar]	Switching sequence	Dimensions			Weight (gross) approx. [kg]	Protection IP
					Width [mm]	Height [mm]	Depth [mm]		

Power Factor Correction Systems in sheet steel cabinets (width = 600 mm), rated mains voltage: 400 V / 50 Hz

Type series: LSFC ...-P1

34-22615	LSFC 75-6,25-212-400-64-620-P1	75	6.25	1:1:2:4:4	600	2000	400	189	20
34-22616	LSFC 75-12,5-11A-400-64-620-P1	75	12.5	1:2:3	600	2000	400	198	20
34-22617	LSFC 75-12,5-22-400-64-620-P1	75	12.5	1:1:2:2	600	2000	400	216	20
34-22618	LSFC 87,5-6,25-211A-400-64-620-P1	87.5	6.25	1:1:2:4:6	600	2000	400		20
34-22619	LSFC 87,5-12,5-21A-400-64-620-P1	87.5	12.5	1:1:2:3	600	2000	400		20
34-22620	LSFC 100-6,25-213-400-64-620-P1	100	6.25	1:1:2:4:4:4	600	2000	400		20
34-22621	LSFC 100-12,5-23-400-64-620-P1	100	12.5	1:1:2:2:2	600	2000	400		20
34-22622	LSFC 100-25-4-400-64-620-P1	100	25	1:1:1:1	600	2000	400		20
34-22623	LSFC 112,5-12,5-11B-400-64-620-P1	112.5	12.5	1:2:3:3	600	2000	400		20
34-22624	LSFC 125-12,5-21B-400-64-620-P1	125	12.5	1:1:2:3:3	600	2000	400		20
34-22625	LSFC 150-37,5-4-400-64-620-P1	150	37.5	1:1:1:1	600	2000	400		20
34-22626	LSFC 150-25-22-400-66-620-P1	150	25	1:1:2:2	600	2110	600		41
34-22627	LSFC 175-25-13-400-66-620-P1	175	25	1:2:2:2	600	2110	600		41
34-22628	LSFC 200-50-4-400-66-620-P1	200	50	1:1:1:1	600	2110	600		41

Power Factor Correction Systems, extension units in sheet steel cabinets (width = 600 mm), rated mains voltage: 400 V / 50 Hz

Type series: LSFCZ ...-P1

34-16666	LSFCZ 150-50-3-400-66-P1	150	50	1:1:1	600	2110	600		41
34-16667	LSFCZ 200-50-4-400-66-P1	200	50	1:1:1:1	600	2110	600		41

Power Factor Correction Systems in sheet steel cabinets (width = 800 mm), rated mains voltage: 400 V / 50 Hz

Type series: LSFC ...-P1

34-22629	LSFC 100-12,5-211-400-85-620-P1	100	12.5	1:1:2:4	800	2110	500	257	41
34-22630	LSFC 100-25-21-400-85-620-P1	100	25	1:1:2	800	2110	500	251	41
34-22631	LSFC 125-12,5-221-400-85-620-P1	125	12.5	1:1:2:2:4	800	2110	500	282	41
34-22632	LSFC 125-25-12-400-85-620-P1	125	25	1:2:2	800	2110	500	264	41
34-22633	LSFC 150-12,5-212-400-85-620-P1	150	12.5	1:1:2:4:4	800	2110	500	309	41
34-22634	LSFC 150-25-22-400-85-620-P1	150	25	1:1:2:2	800	2110	500	301	41
34-22635	LSFC 175-25-13-400-85-620-P1	175	25	1:2:2:2	800	2110	500	328	41
34-22636	LSFC 200-12,5-213-400-85-620-P1	200	12.5	1:1:2:4:4:4	800	2110	500	340	41
34-22637	LSFC 200-25-23-400-85-620-P1	200	25	1:1:2:2:2	800	2110	500	371	41
34-22638	LSFC 225-25-14-400-85-620-P1	225	25	1:2:2:2:2	800	2110	500	382	41
34-22639	LSFC 250-25-24-400-85-620-P1	250	25	1:1:2:2:2:2	800	2110	500	416	41
34-22640	LSFC 250-50-5-400-85-620-P1	250	50	1:1:1:1:1	800	2110	500	403	41
34-22641	LSFC 275-25-15-400-85-620-P1	275	25	1:2:2:2:2:2	800	2110	500	427	41
34-22642	LSFC 300-25-25-400-85-650-P1	300	25	1:1:2:2:2:2:2	800	2110	500	470	41
34-22643	LSFC 300-50-6-400-85-620-P1	300	50	1:1:1:1:1:1	800	2110	500	466	41
34-22644	LSFC 325-25-16-400-85-650-P1	325	25	1:2:2:2:2:2:2	800	2110	500	444	41
34-22645	LSFC 350-25-26-400-85-650-P1	350	25	1:1:2:2:2:2:2:2	800	2110	500	533	41
34-22646	LSFC 350-50-7-400-85-650-P1	350	50	1:1:1:1:1:1:1	800	2110	500	516	41
34-22647	LSFC 375-25-17-400-85-650-P1	375	25	1:2:2:2:2:2:2:2	800	2110	500	534	41
34-22648	LSFC 400-50-8-400-85-650-P1	400	50	1:1:1:1:1:1:1:1	800	2110	500	573	41
34-22649	LSFC 500-50-0-400-86-650-P1	500	50	1:1:1:1:1:1:1:1:1	800	2110	600	670	41

Power Factor Correction Systems

Power Factor Correction Systems – detuned

Article- No.	Type	Rated power [kvar]	Stage power [kvar]	Switching sequence	Dimensions			Weight (gross) approx. [kg]	Protection IP
					Width [mm]	Height [mm]	Depth [mm]		

Power Factor Correction Systems, extension units in sheet steel cabinets (width = 800 mm), rated mains voltage: 400 V / 50 Hz
Type series: LSFCZ ...-P1

34-16209	LSFCZ 100-50-2-400-85-P1	100	50	1:1	800	2110	500	230	41
34-16210	LSFCZ 150-50-3-400-85-P1	150	50	1:1:1	800	2110	500	338	41
34-16211	LSFCZ 200-50-4-400-85-P1	200	50	1:1:1:1	800	2110	500	354	41
34-16212	LSFCZ 250-50-5-400-85-P1	250	50	1:1:1:1:1	800	2110	500	397	41
34-16213	LSFCZ 300-50-6-400-85-P1	300	50	1:1:1:1:1:1	800	2110	500	460	41
34-16214	LSFCZ 350-50-7-400-85-P1	350	50	1:1:1:1:1:1:1	800	2110	500	503	41
34-16215	LSFCZ 400-50-8-400-85-P1	400	50	1:1:1:1:1:1:1:1	800	2110	500	579	41

Other rated voltages, frequencies and power ratings on request.

Recommended supply lead cross sections: please refer to the technical annex (page 137 ff.).

Version: P7 (Detuning factor $p = 7\%$)

Article- No.	Type	Rated power [kvar]	Stage power [kvar]	Switching sequence	Dimensions			Weight (gross) approx. [kg]	Protection IP
					Width [mm]	Height [mm]	Depth [mm]		

Power Factor Correction Systems in sheet steel cabinets (width = 600 mm), rated mains voltage: 400 V / 50 Hz
Type series: LSFC ...-P7

34-22650	LSFC 75-6,25-212-400-64-620-P7	75	6.25	1:1:2:4:4	600	2000	400	174	20
34-22651	LSFC 75-12,5-11A-400-64-620-P7	75	12.5	1:2:3	600	2000	400	174	20
34-22652	LSFC 75-12,5-22-400-64-620-P7	75	12.5	1:1:2:2	600	2000	400	181	20
34-22653	LSFC 93,75-6,25-1111-400-64-620-P7	93.75	6.25	1:2:4:8	600	2000	400	184	20
34-22654	LSFC 100-12,5-211-400-64-620-P7	100	12.5	1:1:2:4	600	2000	400	188	20
34-22655	LSFC 100-25-21-400-64-620-P7	100	25	1:1:2	600	2000	400	191	20
34-22656	LSFC 125-12,5-221-400-64-620-P7	125	12.5	1:1:2:2:4	600	2000	400	216	20
34-22657	LSFC 125-25-12-400-64-620-P7	125	25	1:2:2	600	2000	400	204	20
34-22658	LSFC 150-12,5-212-400-64-620-P7	150	12.5	1:1:2:4:4	600	2000	400	233	20
34-22659	LSFC 150-25-22-400-64-620-P7	150	25	1:1:2:2	600	2000	400	228	20
34-22660	LSFC 175-25-13-400-64-620-P7	175	25	1:2:2:2	600	2000	400	243	20
34-22661	LSFC 200-12,5-213-400-64-620-P7	200	12.5	1:1:2:4:4:4	600	2000	400	274	20
34-22662	LSFC 200-25-23-400-64-620-P7	200	25	1:1:2:2:2	600	2000	400	268	20
34-22663	LSFC 200-50-4-400-64-620-P7	200	50	1:1:1:1	600	2000	400	268	20

Power Factor Correction Systems, extension units in sheet steel cabinets (width = 600 mm), rated mains voltage: 400 V / 50 Hz
Type series: LSFCZ ...-P7

34-16221	LSFCZ 100-50-2-400-64-P7	100	50	1:1	600	2000	400	181	20
34-16222	LSFCZ 150-50-3-400-64-P7	150	50	1:1:1	600	2000	400	226	20
34-16223	LSFCZ 200-50-4-400-64-P7	200	50	1:1:1:1	600	2000	400	193	20

Power Factor Correction Systems in sheet steel cabinets (width = 800 mm), rated mains voltage: 400 V / 50 Hz
Type series: LSFC ...-P7

34-22664	LSFC 100-12,5-211-400-84-620-P7	100	12.5	1:1:2:4	800	2000	400	213	20
34-22665	LSFC 100-12,5-211-400-85-620-P7	100	12.5	1:1:2:4	800	2000	500	202	20
34-22666	LSFC 100-25-21-400-84-620-P7	100	25	1:1:2	800	2000	400	189	20
34-22667	LSFC 125-12,5-221-400-84-620-P7	125	12.5	1:1:2:2:4	800	2000	400	218	20
34-22668	LSFC 125-25-12-400-84-620-P7	125	25	1:2:2	800	2000	400	214	20
34-22669	LSFC 150-12,5-212-400-84-620-P7	150	12.5	1:1:2:4:4	800	2000	400	234	20
34-22670	LSFC 150-25-22-400-84-620-P7	150	25	1:1:2:2	800	2000	400	234	20

Power Factor Correction Systems

Power Factor Correction Systems – detuned

Article- No.	Type	Rated power	Stage power	Switching sequence	Dimensions			Weight (gross) approx. [kg]	Protection IP
		[kvar]	[kvar]		Width [mm]	Height [mm]	Depth [mm]		
34-22671	LSFC 175-25-13-400-84-620-P7	175	25	1:2:2:2	800	2000	400	247	20
34-22672	LSFC 187,5-12,5-113-400-84-620-P7	187.5	12.5	1:2:4:4:4	800	2000	400	260	20
34-22673	LSFC 200-12,5-213-400-85-620-P7	200	12.5	1:1:2:4:4:4	800	2000	500	288	20
34-22674	LSFC 200-25-23-400-84-620-P7	200	25	1:1:2:2:2	800	2000	400	263	20
34-22675	LSFC 225-25-14-400-84-620-P7	225	25	1:2:2:2:2	800	2000	400	294	20
34-22676	LSFC 250-25-24-400-84-620-P7	250	25	1:1:2:2:2:2	800	2000	400	314	20
34-22677	LSFC 250-50-5-400-84-620-P7	250	50	1:1:1:1:1	800	2000	400	308	20
34-22678	LSFC 275-25-15-400-84-620-P7	275	25	1:2:2:2:2:2	800	2000	400	326	20
34-22679	LSFC 300-25-25-400-84-650-P7	300	25	1:1:2:2:2:2:2	800	2000	400	347	20
34-22680	LSFC 300-50-6-400-84-620-P7	300	50	1:1:1:1:1:1	800	2000	400	343	20
34-22681	LSFC 325-25-16-400-84-650-P7	325	25	1:2:2:2:2:2:2	800	2000	400	369	20
34-22682	LSFC 350-25-26-400-84-650-P7	350	25	1:1:2:2:2:2:2:2	800	2000	400	384	20
34-22683	LSFC 350-50-7-400-84-650-P7	350	50	1:1:1:1:1:1:1	800	2000	400	384	20
34-22684	LSFC 375-25-17-400-84-650-P7	375	25	1:2:2:2:2:2:2:2	800	2000	400	404	20
34-22685	LSFC 400-25-27-400-84-650-P7	400	25	1:1:2:2:2:2:2:2:2	800	2000	400	420	20
34-22686	LSFC 400-50-8-400-84-650-P7	400	50	1:1:1:1:1:1:1:1	800	2000	400	417	20
34-22687	LSFC 500-50-0-400-85-650-P7	500	50	1:1:1:1:1:1:1:1:1	800	2110	500	509	41

Power Factor Correction Systems, extension units in sheet steel cabinets (width = 800 mm), rated mains voltage: 400 V / 50 Hz

Type series: LSFCZ ...-P7

34-16202	LSFCZ 100-50-2-400-84-P7	100	50	1:1	800	2000	400	187	20
34-16203	LSFCZ 150-50-3-400-84-P7	150	50	1:1:1	800	2000	400	229	20
34-16204	LSFCZ 200-50-4-400-84-P7	200	50	1:1:1:1	800	2000	400	261	20
34-16205	LSFCZ 250-50-5-400-84-P7	250	50	1:1:1:1:1	800	2000	400	279	20
34-16206	LSFCZ 300-50-6-400-84-P7	300	50	1:1:1:1:1:1	800	2000	400	345	20
34-16207	LSFCZ 350-50-7-400-84-P7	350	50	1:1:1:1:1:1:1	800	2000	400	387	20
34-16208	LSFCZ 400-50-8-400-84-P7	400	50	1:1:1:1:1:1:1:1	800	2000	400	418	20

Versions with an 8 % choke factor are available with the same corrective power and configuration of the capacitance stages.

Other rated voltages, frequencies and power ratings on request.

Recommended supply lead cross sections: please refer to the technical annex (page 137 ff.).

Power Factor Correction Systems

Power Factor Correction Systems – detuned

Version: P5 (Detuning factor p = 5.67 %)

Article- No.	Type	Rated power [kvar]	Stage power [kvar]	Switching sequence	Dimensions			Weight (gross) approx. [kg]	Protection IP
					Width [mm]	Height [mm]	Depth [mm]		

Power Factor Correction Systems in sheet steel cabinets (width = 600 mm), rated mains voltage: 400 V / 50 Hz

Type series: LSFC ...-P5

34-22751	LSFC 100-25-21-400-64-650-P5	100	25	1:1:2	600	2000	400	210	20
34-22752	LSFC 125-25-12-400-64-650-P5	125	25	1:2:2	600	2000	400	240	20
34-22753	LSFC 150-25-22-400-64-650-P5	150	25	1:1:2:2	600	2000	400	280	20
34-22754	LSFC 175-25-13-400-64-650-P5	175	25	1:2:2:2	600	2000	400	303	20
34-22755	LSFC 200-50-4-400-64-650-P5	200	50	1:1:1:1	600	2000	400	318	20

Power Factor Correction Systems, extension units in sheet steel cabinets (width = 600 mm), rated mains voltage: 400 V / 50 Hz

Type series: LSFCZ ...-P5

34-16641	LSFCZ 100-50-2-400-64-P5	100	50	1:1	600	2000	400	185	20
34-16642	LSFCZ 150-50-3-400-64-P5	150	50	1:1:1	600	2000	400	248	20
34-16643	LSFCZ 200-50-4-400-64-P5	200	50	1:1:1:1	600	2000	400	310	20

Power Factor Correction Systems in sheet steel cabinets (width = 800 mm), rated mains voltage: 400 V / 50 Hz

Type series: LSFC ...-P5

34-22756	LSFC 100-25-21-400-85-650-P5	100	25	1:1:2	800	2110	500	195	41
34-22757	LSFC 125-25-12-400-85-650-P5	125	25	1:2:2	800	2110	500	230	41
34-22758	LSFC 150-25-22-400-85-650-P5	150	25	1:1:2:2	800	2110	500	250	41
34-22759	LSFC 175-25-13-400-85-650-P5	175	25	1:2:2:2	800	2110	500	285	41
34-22760	LSFC 200-25-23-400-85-650-P5	200	25	1:1:2:2:2	800	2110	500	305	41
34-22761	LSFC 225-25-14-400-85-650-P5	225	25	1:2:2:2:2	800	2110	500	330	41
34-22762	LSFC 250-25-24-400-85-650-P5	250	25	1:1:2:2:2:2	800	2110	500	344	41
34-22763	LSFC 250-50-5-400-85-650-P5	250	50	1:1:1:1:1	800	2110	500	396	41
34-22764	LSFC 275-25-15-400-85-650-P5	275	25	1:2:2:2:2:2	800	2110	500	422	41
34-22765	LSFC 300-25-25-400-85-650-P5	300	25	1:1:2:2:2:2:2	800	2110	500	435	41
34-22766	LSFC 300-50-6-400-85-650-P5	300	50	1:1:1:1:1:1	800	2110	500	422	41
34-22767	LSFC 325-25-16-400-85-650-P5	325	25	1:2:2:2:2:2:2	800	2110	500	460	41
34-22768	LSFC 350-25-26-400-85-650-P5	350	25	1:1:2:2:2:2:2:2	800	2110	500	520	41
34-22769	LSFC 350-50-7-400-85-650-P5	350	50	1:1:1:1:1:1:1	800	2110	500	526	41
34-22770	LSFC 375-25-17-400-85-650-P5	375	25	1:2:2:2:2:2:2:2	800	2110	500	555	41
34-22771	LSFC 400-50-8-400-85-650-P5	400	50	1:1:1:1:1:1:1:1	800	2110	500	565	41
34-22772	LSFC 500-50-0-400-86-650-P5	500	50	1:1:1:1:1:1:1:1:1	800	2110	600	640	41

Power Factor Correction Systems, extension units in sheet steel cabinets (width = 800 mm), rated mains voltage: 400 V / 50 Hz

Type series: LSFCZ ...-P5

34-16634	LSFCZ 100-50-2-400-85-P5	100	50	1:1	800	2110	500	220	41
34-16635	LSFCZ 150-50-3-400-85-P5	150	50	1:1:1	800	2110	500	260	41
34-16636	LSFCZ 200-50-4-400-85-P5	200	50	1:1:1:1	800	2110	500	300	41
34-16637	LSFCZ 250-50-5-400-85-P5	250	50	1:1:1:1:1	800	2110	500	350	41
34-16638	LSFCZ 300-50-6-400-85-P5	300	50	1:1:1:1:1:1	800	2110	500	410	41
34-16639	LSFCZ 350-50-7-400-85-P5	350	50	1:1:1:1:1:1:1	800	2110	500	460	41
34-16640	LSFCZ 400-50-8-400-85-P5	400	50	1:1:1:1:1:1:1:1	800	2110	500	510	41

Other rated voltages, frequencies and power ratings on request.

Recommended supply lead cross sections: please refer to the technical annex (page 137 ff.).

Power Factor Correction Systems

Power Factor Correction Systems – detuned

Options and accessories for Power Factor Correction Systems type LSFC-P 400 V, 50 Hz

Options, mounted and wired ready for operation

Article-No.	Type	Description	for System type
S34-5540	-650- (instead of -620)	Power Factor Control Relay PQC-12/1 instead of PQC-6/1	all
S34-5519	-66- (instead of -64-)	FRAKO LSFC-66, WxHxD: 600x2000x600 mm (without floor standing base and roof)	LSFC-64
S34-5528	-66- (instead of -84-)	FRAKO LSFC-66, WxHxD: 600x2000x600 mm (without floor standing base and roof)	LSFC-84
S34-5503	-84- (instead of -64-)	FRAKO LSFC-84, WxHxD: 800x2000x400 mm (without floor standing base and roof)	LSFC-64
S34-5524	-85- (instead of -84-)	FRAKO LSFC-85, WxHxD: 800x2000x500 mm (without floor standing base and roof)	LSFC-84
S34-5517	-86- (instead of -84/85-)	FRAKO LSFC-86, WxHxD: 800x2000x600 mm (without floor standing base and roof)	LSFC-84/-85
S34-5554	-119- (instead of -64-)	Rittal VX 8604, WxHxD: 600x2000x400 mm (without floor standing base and roof)	LSFC-64
S34-5555	-118- (instead of -84/85-)	Rittal VX 8606 WxHxD: 600x2000x600 mm (without floor standing base and roof)	LSFC-84/-85
S34-5556	-117- (instead of -84-)	Rittal VX 8804, WxHxD: 800x2000x400 mm (without floor standing base and roof)	LSFC-84
S34-5557	-116- (instead of -85-)	Rittal VX 8805, WxHxD: 800x2000x500 mm (without floor standing base and roof)	LSFC-85
S34-5558	-115- (instead of -84-)	Rittal VX 8806, WxHxD: 800x2000x600 mm (without floor standing base and roof)	LSFC-84
S34-5559	-115- (instead of -85-)	Rittal VX 8806, WxHxD: 800x2000x600 mm (without floor standing base and roof)	LSFC-85
S34-5509	-Li	Cabinet door with door left hinged	all type FRAKO LSFC
S34-5510	-Li	Cabinet door with door left hinged	all type Rittal VX
S34-5023	-S60	Pivoting lever closure for mounting a semiprofile cylinder	all
S34-0060	-SO (+ Description)	Special painting outside (RAL-Scale)	all
S34-0010	-S1	Cable entry through the switch cabinet roof with connection at the top	up to 400 kvar/Cabinet
S34-5512	-54	Ingress protection IP54	≤ 300 kvar/Cabinet
S34-5513	-54	Ingress protection IP54	> 300 ≤ 400 kvar/Cabinet
S34-0054	-S80	Ingress protection IPX1 with dust cover roof W x H x D (mm) 520 x 300 x 50; RAL 7035	all FRAKO LSFC
S34-5523	-S572	Ingress protection IP41, roof vent installation on cabinet instead of a roof vent installation in cabinet	≤ 400 kvar/Cabinet
S34-5511	-S131	Fuse switch disconnecter instead of fuse base per 50 kvar	all
S34-5514	-SLTA	Fuse switch disconnecter in cable entry compartment	≤ 200 kvar/Cabinet
S34-5515	-SLTA	Fuse switch disconnecter in cable entry compartment	≤ 300 kvar/Cabinet
S34-0109	-LSA	Switch disconnecter* three-pole, 400 A in cable entry compartment, for cabinet width 600 mm	≤ 200 kvar/Cabinet
S34-0108	-LSA	Switch disconnecter* three-pole, 400 A in cable entry compartment, for cabinet width 800 mm	≤ 200 kvar/Cabinet
S34-0107	-LSA	Switch disconnecter* three-pole, 630 A in cable entry compartment, for cabinet width 600 mm	≤ 300 kvar/Cabinet
S34-0106	-LSA	Switch disconnecter* three-pole, 630 A in cable entry compartment, for cabinet width 800 mm	≤ 300 kvar/Cabinet
S34-0039	-S56	Control switch (On/Off) fitted and connected (requirement for power factor correction systems installed in Switzerland)	all
S34-5535	-S19	Control phase + N via a protective motor switch (option for France)	all

Power Factor Correction Systems

Power Factor Correction Systems – detuned

Article-No.	Type	Description	for System type
S34-5536	-S119	Control transformer set 500 VA primary and secondary fuses	≤ 500 kvar
S34-5526	-S119	Control transformer set 800 VA incl. primary and secondary fuses	> 500 ≤ 900 kvar
S34-5069	-S53	3 ammeter incl. current transformer	all
S34-5073	-SO (+ Description)	Voltage meter with switch	all
S34-5077	-SO (+ Description)	kvar-Meter incl. current transformer; measuring range up to 300 kvar, 400 V	all
S34-5057	-SO (+ Description)	Measuring transducer 4-20 mA or power factor	all
S34-0040	-S66	Summation current transformer 5+5/5A	all
S34-0081	-S66	Summation current transformer 5+5+5/5A	all
S34-5049	-S145	Switch cabinet lighting with power outlet and position switch	all

*) Switch disconnecter can be operated from the outside

Accessories

Article-No.	Type	Description	Dimensions (W x D) in mm	for System type
34-80090	KR-LSFC-64-100	Floor standing base (h = 100 mm)	600 x 400	LSFC-64
34-80175	KR-LSFC-64-200	Floor standing base (h = 200 mm)	600 x 400	LSFC-64
34-80122	KR-LSFC-66-100	Floor standing base (h = 100 mm)	600 x 600	LSFC-66
34-80125	KR-LSFC-66-200	Floor standing base (h = 200 mm)	600 x 600	LSFC-66
34-80091	KR-LSFC-84-100	Floor standing base (h = 100 mm)	800 x 400	LSFC-84
34-80113	KR-LSFC-84-200	Floor standing base (h = 200 mm)	800 x 400	LSFC-84
34-80079	KR-LSFC-85-100	Floor standing base (h = 100 mm)	800 x 500	LSFC-85
34-80075	KR-LSFC-85-200	Floor standing base (h = 200 mm)	800 x 500	LSFC-85
34-80092	KR-LSFC-86-100	Floor standing base (h = 100 mm)	800 x 600	LSFC-86
34-80112	KR-LSFC-86-200	Floor standing base (h = 200 mm)	800 x 600	LSFC-86

Other options and accessories on request

Dimensions

Power Factor Correction Systems

Power Factor Correction Systems – detuned

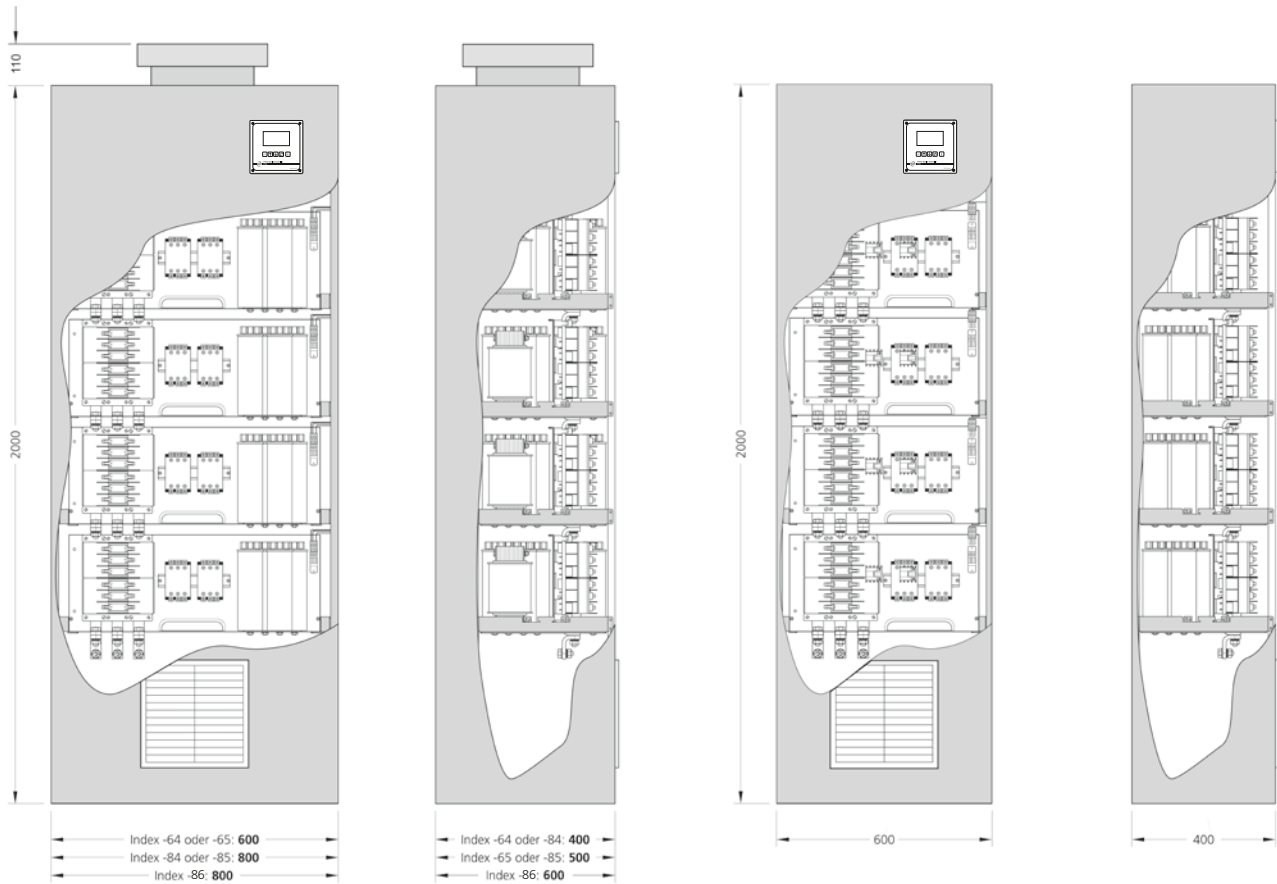

Dimensional drawing LSFC-P (100 to 500 kvar)

All dimensions in mm

Power Factor Correction Systems

Power Factor Correction Systems – detuned

Base/plinth system VX

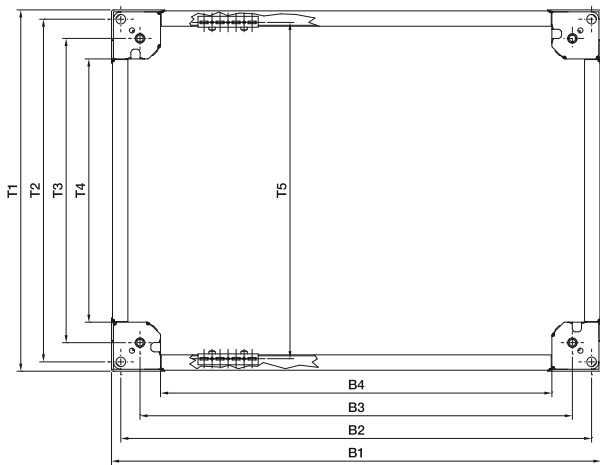

Dimensional drawing base/plinth 100 mm high

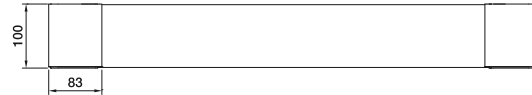

Dimensional drawing base/plinth 200 mm high

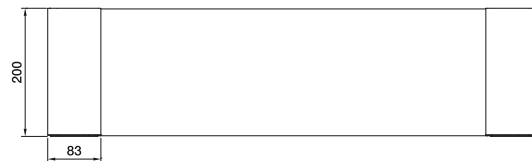

Description of the hole pattern

B1/T1 = outer dimensions

B2/T2 = for screwing with the corner piece of the cabinet
(from below)

B3/T3 = for screwing to the cabinet bottom with a captive nut
(from below or above)

For fixing to the floor, drill holes B2-B4/T2-T3 can be used.

Base/plinth trim panels, solid, 100 mm high, front view

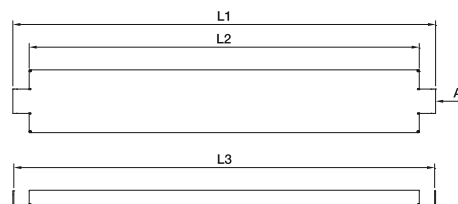

Base/plinth trim panels, solid, 200 mm high, front view

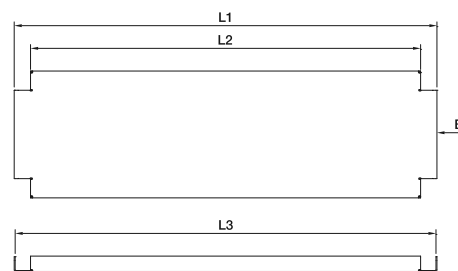

For enclosure width or depth mm	Width dimensions mm				Length dimensions mm			Depth dimensions mm				
	B1	B2	B3	B4	L1	L2	L3	T1	T2	T3	T4	T5 ¹⁾
400	366	335	275	211	260	209	257	364	335	275	211	325
500	466	435	375	311	360	309	357	464	435	375	311	425
600	566	535	475	411	460	409	457	564	535	475	411	525
800	766	735	675	611	660	609	657	764	735	675	611	725

¹⁾ T5 = Distance between system punchings including base/plinth installation bracket

All dimensions in mm

Power Factor Correction Systems

MCS – Modular Construction System



MCS Modular Construction System

5

The FRAKO Modular Construction System MCS is a modular system, with which a skilled switchgear manufacturer can design a technically high-quality Power Factor Correction System. However, knowing our “Manual of Power Factor Correction” is absolutely important to design such a Power Factor Correction System. In this manual one will find all the necessary planning information as well as all the important technical data. You can download the manual free of charge from our website or order it free of charge from your local FRAKO partner.

The FRAKO MCS consists of selected and tested components for designing Power Factor Correction Systems. FRAKO uses these components for its own production of Power Factor Correction Systems in Teningen. This way the skilled switchgear manufacturer can gain from an experience and application know-how of more than 85 years.

The FRAKO Modular Construction System contains the following components:

- Power Factor Control Relay
- Control terminal strip for Power Factor Control Relay and Power Factor Correction Systems
- Control wires
- Busbar holders
- NH-fuse base and NH-isolating switch
- NH-fuse links
- Contactors
- Discharge Reactors
- Harmonic Filter Reactors
- Power Factor Correction Capacitors
- Thyristor switches

Power Factor Correction Systems

MCS – Modular Construction System

Technical Data

For the design of Power Factor Correction Systems **FRAKO** recommends to use the below-mentioned devices and fuses.

• Busbar Holders

The busbar holders have a centre to centre distance of 60 mm to the single copper busbars. The copper busbars have either dimensions of 30 x 5 mm or 30 x 10 mm, depending on the total power of the Power Factor Correction System.

Article-No.	Description
34-80375	Busbar holder with a bar centre to centre distance of 60 mm, Cu 30 x 10 mm



• NH-Fuse Holders

To assemble reasonably priced Power Factor Correction Systems, NH-fuse holders size 00 up to a mains rated voltage of 690 V AC, can be used. These NH-fuse holders are also available as bus-mounting fuse holders for direct mounting on a busbar system with a bar centre to centre distance of 60 mm, or for mounting on mounting plates.

Article-No.	Description
34-80372	NH-bus-mounting fuse base, size 00, 160 A, 690 V AC
34-80280	NH-bus-mounting fuse base, size 00, 160 A, 690 V AC
34-80272	NH-fuse base for plate mounting, size 00, 160 A, 690 V AC
34-80283	NH-fuse base for plate mounting, size 00, 160 A, 690 V AC
34-80373	Cover for NH-fuses with nonisolated grip lugs



34-80283



34-80280



34-80272



34-80372

• NH-Isolating Switch

NH-isolating switch size 00. Applicable up to a mains rated voltage of 690 V AC. Available as NH-bus-mounting isolating switches for direct mounting on a busbar system with 60 mm bar centre to centre distance or for mounting on mounting plates.

Article-No.	Description
34-80374	NH-isolating switch for plate mounting, size 00, 160 A, 690 V AC
34-80282	NH-isolating switch for plate mounting, size 00, 160 A, 690 V AC
34-80281	NH-bus-mounting isolating switch, size 00, 160 A, 690 V AC



34-80281



34-80282



34-80374

When operating the above mentioned devices, please note that special attention has to be paid to the corresponding safety regulations, especially the regulations concerning accident prevention!

Power Factor Correction Systems

MCS – Modular Construction System

• Fuses

Article-No.	Description
90-00289	Cylindrical fuse 10x38 6 A 500 V (for PQC)
90-00367	Cylindrical fuse 14x51 6 A 690 V (for PQC)
90-00229	Fuse link with nonisolated metal grip lugs 25 A, 500 V AC
90-00062	Fuse link with isolated metal grip lugs 25 A, 500 V AC
90-00131	Fuse link with nonisolated metal grip lugs 35 A, 500 V AC
90-00056	Fuse link with isolated metal grip lugs 35 A, 500 V AC
90-00130	Fuse link with nonisolated metal grip lugs 50 A, 500 V AC
90-00055	Fuse link with isolated metal grip lugs 50 A, 500 V AC
90-00125	Fuse link with nonisolated metal grip lugs 63 A, 500 V AC
90-00054	Fuse link with isolated metal grip lugs 63 A, 500 V AC
90-00124	Fuse link with nonisolated metal grip lugs 80 A, 500 V AC
90-00053	Fuse link with isolated metal grip lugs 80 A, 500 V AC
90-00126	Fuse link with nonisolated metal grip lugs 100 A, 500 V AC
90-00052	Fuse link with isolated metal grip lugs 100 A, 500 V AC
90-00051	Fuse link with isolated metal grip lugs 125 A, 500 V AC
90-00050	Fuse link with isolated metal grip lugs 160 A, 500 V AC
90-00230	Fuse link with isolated metal grip lugs 35 A, 690 V AC
90-00132	Fuse link with isolated metal grip lugs 40 A, 690 V AC
90-00111	Fuse link with isolated metal grip lugs 50 A, 690 V AC
90-00133	Fuse link with isolated metal grip lugs 63 A, 690 V AC

For options and accessory equipment for PFC Systems, module rails, ordering examples and dimensional drawings see page 87 ff.

Technical Annex

Supply Lead Cross Sections

Page 137

Guide to selection: Harmonic Filter Reactors → Capacitors

Page 139



Supply lead cross sections for Power Factor Correction Systems

Connection, fuses and supply lead cross sections

When installation work is carried out, the regulations VDE 0100 and VDE 0105, of the German Association for Electrical, Electronic & Information Technologies, the general guidelines of the BDEW (German Association of Energy and Water Industries) and the conditions of supply of the utility company concerned must be complied with. EN 60831-1 resp. VDE 0560 Part 46 state that capacitor units must be suitable for a continuous r.m.s. current of 1.3 times the current that is drawn at the sinusoidal rated voltage and rated frequency. If the capacitance tolerance of $1.1 \times C_N$ is also taken into account, the maximum allowable current can reach values of up to $1.43 \times I_N$. This overload capability together with the high in-rush current to the capacitors must be taken into account when designing protective devices and cable cross sections.

Note! FRAKO power capacitors offer a current load capacity of 1.5 up to $2.7 \times I_N$ at rated voltage.

FRAKO Power Factor Correction Capacitors with terminal base ensure a maintenance free electrical contact with the connecting wire by using the patented spring clamp technology! The terminal base provides protection against accidental contact! The connecting wires have to be flexible in order not to hinder the proper function of the overpressure disconnecter.

Please note that the current transformer, needed for the operation of the system, is not included with delivery.

Technical Annex

Supply Lead Cross Sections

Rated mains voltage: 400 V / 50 Hz

Power rating [kvar]	Rated current [A]	Fuse gL/gG [A]	Supply lead cross section ¹⁾ (4-wire) [mm]	Supply lead cross section ¹⁾ (5-wire) [mm]
7.50	11	16	4 x 2.5	5 x 2.5
10.00	14	20	4 x 2.5	5 x 2.5
12.50	18	25	4 x 4	5 x 4
15.00	22	35	4 x 6	5 x 6
17.50	25	35	4 x 6	5 x 6
20.00	29	50	4 x 10	4 x 10/ 10
25.00	36	50	4 x 16	4 x 16/ 16
27.50	40	63	4 x 16	4 x 16/ 16
30.00	43	63	4 x 16	4 x 16/ 16
31.25	45	63	4 x 16	4 x 16/ 16
37.50	54	80	3 x 25/16	4 x 25/ 16
40.00	58	80	3 x 25/16	4 x 25/ 16
43.75	63	100	3 x 35/16	4 x 35/ 16
46.88	68	100	3 x 35/16	4 x 35/ 16
50.00	72	100	3 x 35/16	4 x 35/ 16
52.50	76	125	3 x 50/25	4 x 50/ 25
60.00	87	125	3 x 50/25	4 x 50/ 25
62.50	90	125	3 x 50/25	4 x 50/ 25
68.75	99	160	3 x 70/35	4 x 70/ 35
75.00	108	160	3 x 70/35	4 x 70/ 35
80.00	115	160	3 x 70/35	4 x 70/ 35
93.75	135	200	3 x 95/50	4 x 95/ 50
100.00	144	200	3 x 95/50	4 x 95/ 50
112.50	162	250	3 x 120/70	4 x 120/ 70
125.00	180	250	3 x 120/70	4 x 120/ 70
143.75	207	315	3 x 185/95	4 x 185/ 95
150.00	217	315	3 x 185/95	4 x 185/ 95
175.00	253	400	2 x 3 x 95/50	2 x 4 x 95/ 50
187.50	271	400	2 x 3 x 95/50	2 x 4 x 95/ 50
200.00	289	400	2 x 3 x 95/50	2 x 4 x 95/ 50
225.00	325	500	2 x 3 x 120/70	2 x 4 x 120/ 70
250.00	361	500	2 x 3 x 120/70	2 x 4 x 120/ 70
275.00	397	630	2 x 3 x 185/95	2 x 4 x 185/ 95
300.00	433	630	2 x 3 x 185/95	2 x 4 x 185/ 95
325.00	469	800	2 x 3 x 240/120	2 x 4 x 240/ 120
350.00	505	800	2 x 3 x 240/120	2 x 4 x 240/ 120
375.00	541	800	2 x 3 x 240/120	2 x 4 x 240/ 120
400.00	577	800	2 x 3 x 240/120	2 x 4 x 240/ 120
450.00	650	1000	3 x 3 x 185/95	3 x 4 x 185/ 95
500.00	722	1000	3 x 3 x 185/95	3 x 4 x 185/ 95

¹⁾ Recommended supply lead cross section according to VDE 0298, table 4, installation type C

The neutral conductor requires a minimum cross section of 1.5 mm².

Technical Annex

Guide to selection: Harmonic Filter Reactors → Capacitors



Harmonic Filter Reactors (Basic / Standard)

Guide to selection: Harmonic Filter Reactors → Capacitors

Guide to selection: Harmonic Filter Reactors → Capacitors

The following recommended capacitors may differ from the assembly of our power factor correction systems.

Basic Harmonic Filter Reactors

Detuning factor $p = 7\%$

Article-No.	Type	Q	C	Type and quantity of the capacitors required														
				LKT 10-525-DP Article-No. 31-10517	LKT 11,7-400-DL Article-No. 31-10604	LKT 28,2-440-DP Article-No. 31-10535												
		[kvar]	[μ F]															

FDKT: $V_N = 400\text{ V} / 50\text{ Hz}$

88-02103	FDKT 6.25-400-P7	6.3	3 x 38.5	1														
88-02045	FDKT 12.5-400-P7	12.5	3 x 77.6		1													
88-02046	FDKT 25-400-P7	25.0	3 x 155.2		2	1												
88-02047	FDKT 50-400-P7	50.0	3 x 310.4		4	2												
88-02093	FDKT 75-400-P7	75.0	3 x 465.6		6	3												
88-02094	FDKT 100-400-P7	100.0	3 x 620.8		8	4												

Technical Annex

Guide to selection: Harmonic Filter Reactors → Capacitors

Article-No.	Type	Q	C	Type and quantity of the capacitors required							
				[kvar]	[μF]	LKT 15,5-480-DP Article-No. 31-10382					

FDKT: $V_N = 415 \text{ V} / 50 \text{ Hz}$

88-02098	FDKT 12,5-415-P7	12.5	3 x 71.4	1										
88-02099	FDKT 25-415-P7	25.0	3 x 142.8	2										
88-02100	FDKT 50-415-P7	50.0	3 x 285.6	4										
88-02101	FDKT 75-415-P7	75.0	3 x 428.4	6										
88-02190	FDKT 100-415-P7	100.0	3 x 572.3	8										

Article-No.	Type	Q	C	Type and quantity of the capacitors required							
				[kvar]	[μF]	LKT 20-690-DP Article-No. 31-10564					

FDKT: $V_N = 525 \text{ V} / 50 \text{ Hz}$

88-02146	FDKT 12,5-525-P7	12.5	3 x 44.7	1										
88-02147	FDKT 25-525-P7	25.0	3 x 89.4	2										
88-02148	FDKT 50-525-P7	50.0	3 x 178.8	4										
88-02149	FDKT 75-525-P7	75.0	3 x 268.2	6										
88-02150	FDKT 100-525-P7	100.0	3 x 357.6	8										
88-02151	FDKT 150-525-P7	150.0	3 x 536.4	12										
88-02152	FDKT 200-525-P7	200.0	3 x 715.2	16										

Detuning factor $p = 14 \%$

Article-No.	Type	Q	C	Type and quantity of the capacitors required							
				[kvar]	[μF]	LKT 15,5-480-DP Article-No. 31-10382					

FDKT: $V_N = 400 \text{ V} / 50 \text{ Hz}$

88-02095	FDKT 12,5-400-P1	12.5	3 x 71.4	1										
88-02096	FDKT 25-400-P1	25.0	3 x 142.8	2										
88-02097	FDKT 50-400-P1	50.0	3 x 285.6	4										

Technical Annex

Guide to selection: Harmonic Filter Reactors → Capacitors

Article- No.	Type	Q	C	Type and quantity of the capacitors required							
				[kvar]	[μF]						

FDKT: $V_N = 525 \text{ V} / 50 \text{ Hz}$

88-02153	FDKT 12,5-525-P1	12.5	3 x 41.1																
88-02154	FDKT 25-525-P1	25.0	3 x 82.2																
88-02155	FDKT 50-525-P1	50.0	3 x 164.4																
88-02156	FDKT 75-525-P1	75.0	3 x 246.6	Type and quantity of the capacitors required on request															
88-02157	FDKT 100-525-P1	100.0	3 x 328.8																
88-02158	FDKT 150-525-P1	150.0	3 x 439.2																
88-02159	FDKT 200-525-P1	200.0	3 x 657.6																

Standard Harmonic Filter Reactors

Detuning factor $p = 5.67 \%$

Article- No.	Type	Q	C	Type and quantity of the capacitors required							
				[kvar]	[μF]	LKT 11,7-400-DL Article-No. 31-10604	LKT 28,2-440-DP Article-No. 31-10535				

FDR: $V_N = 400 \text{ V} / 50 \text{ Hz}$

88-02141	FDR 25-400-P5	25.0	3 x 155.2	2	1														
88-02142	FDR 50-400-P5	50.0	3 x 310.4	4	2														

Technical Annex

Guide to selection: Harmonic Filter Reactors → Capacitors

Detuning factor $p = 7\%$

Article-No.	Type	Q [kvar]	C [μF]	Type and quantity of the capacitors required									
				LKT 10-440-DP Article-No. 31-10508	LKT 10-525-DP Article-No. 31-10517	LKT 10-400-DP Article-No. 31-10380	LKT 12,5-400-DP Article-No. 31-10502						

FDR/FKD: $V_N = 230\text{ V} / 50\text{ Hz}$

88-01980	FDR 5-230-P7	5.0	3 x 93.3	1	1															
88-01575	FKD 10-230-P7	10.0	3 x 200.0			3														
88-01974	FDR 12,5-230-P7	12.5	3 x 232.1			1	2													
88-01583	FKD 16,7-230-P7	16.7	3 x 334.0				4													
88-01576	FKD 20-230-P7	20.0	3 x 400.0			6														
88-01943	FDR 25-230-P7	25.0	3 x 464.2			2	4													
88-01568	FKD 33-230-P7	33.0	3 x 668.0				8													

Article-No.	Type	Q [kvar]	C [μF]	Type and quantity of the capacitors required													
				LKT 3,6-480-DL Article-No. 31-10613	LKT 4,5-480-DL Article-No. 31-10388	LKT 9,3-400-DL Article-No. 31-10602	LKT 7,2-480-DL Article-No. 31-10615	LKT 7,6-440-DL Article-No. 31-10608	LKT 9,1-440-DL Article-No. 31-10387	LKT 10-400-DL Article-No. 31-10603	LKT 11,7-400-DL Article-No. 31-10604			LKT 28,2-440-DP Article-No. 31-10535	LKT 12,5-440-DP Article-No. 31-10507		

FKD/FDR: $V_N = 400\text{ V} / 50\text{ Hz}$

88-01640	FKD 2,5-400-P7	2.5	3 x 16.6	1																
88-01719	FKD 3,13-400-P7	3.13	3 x 19.9		1															
88-01481	FKD 5-400-P7	5.0	3 x 33.2				1													
88-01410	FKD 6.25-400-P7	6.25	3 x 41.5					1												
88-01482	FKD 7.5-400-P7	7.5	3 x 49.7						1											
88-01479	FKD 10-400-P7	10.0	3 x 66.3							1										
88-01767	FDR 12.5-400-P7	12.5	3 x 77.1								1									
88-01362	FKD 15-400-P7	15.0	3 x 99.5								2									
88-01922	FDR 16.7-400-P7	16.7	3 x 102.9			1		1												
88-01363	FKD 20-400-P7	20.0	3 x 132.6								2									
88-01768	FDR 25-400-P7	25.0	3 x 154.2									2	or	1						
88-01484	FKD 30-400-P7	30.0	3 x 198.9								3									
88-01923	FDR 33.3-400-P7	33.3	3 x 205.8																	3
88-02053	FDR 37.5-400-P7	37.5	3 x 213.9									3								
88-01782	FDR 40-400-P7	40.0	3 x 248.8			4														
88-01769	FDR 50-400-P7	50.0	3 x 308.4									4	or	2						

Technical Annex

Guide to selection: Harmonic Filter Reactors → Capacitors

Article-No.	Type	Q	C	Type and quantity of the capacitors required							
				[kvar]	[μF]	LKT 7,8-480-DL Article-No. 31-10616					

FDR: $V_N = 415 \text{ V} / 50 \text{ Hz}$

88-02034	FDR 6,25-415-P7	6.3	3 x 35.9	1										
88-01937	FDR 12,5-415-P7	12.5	3 x 71.4	2										
88-01938	FDR 25-415-P7	25.0	3 x 142.8	4										
88-01930	FDR 50-415-P7	50.0	3 x 285.6	8										

Article-No.	Type	Q	C	Type and quantity of the capacitors required							
				[kvar]	[μF]	LKT 8,33-525-DL Article-No. 31-10622					

FDR/FKD: $V_N = 440 \text{ V} / 50 \text{ Hz}$

88-02160	FDR 6,25-440-P7	6.3	3 x 32.1	1										
88-02161	FDR 12,5-440-P7	12.5	3 x 64.2	2										
88-01008	FKD 25-440-P7	25.0	3 x 132.8	4										
88-01124	FKD 50-440-P7	50.0	3 x 265.6	8										

Article-No.	Type	Q	C	Type and quantity of the capacitors required							
				[kvar]	[μF]	LKT 4,17-525-DL Article-No. 31-10619	LKT 5,9-525-DL Article-No. 31-10620	LKT 7,7-525-DL Article-No. 31-10621			

FDR/FKD: $V_N = 525 \text{ V} / 50 \text{ Hz}$

88-01801	FDR 6,25-525-P7	6.3	3 x 22.9		1									
88-01802	FDR 12,5-525-P7	12.5	3 x 45.8		2									
88-01080	FKD 20-525-P7	20.0	3 x 80.5	1		2								
88-01838	FDR 25-525-P7	25.0	3 x 89.5			3								
88-01837	FDR 50-525-P7	50.0	3 x 179.0			6								
88-01872	FDR 50-525-P7	50.0	3 x 179.0			6								

Technical Annex

Guide to selection: Harmonic Filter Reactors → Capacitors

Article-No.	Type	Q	C	Type and quantity of the capacitors required							
				[kvar]	[μF]	LKT 13,3-800-DP Article-No. 31-10572	LKT 28,2-760-DP Article-No. 31-10569				

FKD/FDR: $V_N = 690 \text{ V} / 50 \text{ Hz}$

88-01825	FKD 10-690-P7	10.0	3 x 22.1	1										
88-01932	FDR 25-690-P7	25.0	3 x 51.5		1									
88-01933	FDR 50-690-P7	50.0	3 x 103.1		2									

Article-No.	Type	Q	C	Type and quantity of the capacitors required							
				[kvar]	[μF]	LKT 10-525-DP Article-No. 31-10517	LKT 11,7-400-DL Article-No. 31-10604	LKT 10-400-DP Article-No. 31-10380	LKT 12,5-400-DP Article-No. 31-10502		

FDR: $V_N = 230 \text{ V} / 60 \text{ Hz}$

88-01996	FDR 2,5-230-P7-60	2.5	3 x 38.5	1										
88-01997	FDR 5-230-P7-60	5.0	3 x 77.3		1									
88-01998	FDR 10-230-P7-60	10.0	3 x 154.6		2									
88-02140	FDR 12,5-230-P7-60	12.5	3 x 194.3	*										
88-02001	FDR 20-230-P7-60	20.0	3 x 309.2		4									
88-01892	FDR 25-230-P7-60	25.0	3 x 385.5			2	3							

Article-No.	Type	Q	C	Type and quantity of the capacitors required							
				[kvar]	[μF]	LKT 15,5-480-DP Article-No. 31-10382					

FDR: $V_N = 380 \text{ V} / 60 \text{ Hz}$

88-02179	FDR 12,5-380-P7-60	12.5	3 x 71.4	1										
88-02180	FDR 25-380-P7-60	25.0	3 x 142.8	2										
88-02181	FDR 50-380-P7-60	50.0	3 x 285.6	4										

* Type and quantity of the capacitors required on request

Technical Annex

Guide to selection: Harmonic Filter Reactors → Capacitors

Article-No.	Type	Q	C	Type and quantity of the capacitors required									
				[kvar]	[μF]	LKT 8,33-525-DL Article-No. 31-10622							

FDR: $V_N = 400 \text{ V} / 60 \text{ Hz}$

88-01963	FDR 12,5-400-P7-60	12.5	3 x 64.2	2														
88-01964	FDR 25-400-P7-60	25.0	3 x 128.1	4														
88-01965	FDR 50-400-P7-60	50.0	3 x 256.9	8														

Article-No.	Type	Q	C	Type and quantity of the capacitors required									
				[kvar]	[μF]	LKT 7,7-525-DL Article-No. 31-10621	LKT 8,33-525-DL Article-No. 31-10622	LKT 5,9-525-DL Article-No. 31-10620	LKT 15,5-480-DP Article-No. 31-10382	LKT 7,8-480-DL Article-No. 31-10616			

FKD/FDR: $V_N = 440 \text{ V} / 60 \text{ Hz}$

88-01914	FKD 6,25-440-P7-60	6.3	3 x 29.9	1														
88-01795	FDR 7,5-440-P7-60	7.5	3 x 32.0		1													
88-01883	FDR 12,5-440-P7-60	12.5	3 x 54.8		1	1												
88-01796	FDR 15-440-P7-60	15.0	3 x 64.0		2													
88-01884	FDR 25-440-P7-60	25.0	3 x 107.2					1	1									
88-01875	FDR 50-440-P7-60	50.0	3 x 214.2					3										

Article-No.	Type	Q	C	Type and quantity of the capacitors required									
				[kvar]	[μF]	LKT 5-690-DP Article-No. 31-10560	LKT 4,5-480-DL Article-No. 31-10388	LKT 10-525-DP Article-No. 31-10517	LKT 12,5-525-DP Article-No. 31-10516				

FKD/FDR: $V_N = 460 \text{ V} / 60 \text{ Hz}$

88-02123	FKD 2,5-460-P7-60	2.5	3 x 11.1	1														
88-02124	FKD 5-460-P7-60	5.0	3 x 20.7		1													
88-02125	FDR 10-460-P7-60	10.0	3 x 38.5			1												
88-01854	FDR 12,5-460-P7-60	12.5	3 x 48.1					1										
88-01855	FDR 25-460-P7-60	25.0	3 x 96.2					2										
88-01856	FDR 50-460-P7-60	50.0	3 x 192.4					4										

Technical Annex

Guide to selection: Harmonic Filter Reactors → Capacitors

Article-No.	Type	Q	C	Type and quantity of the capacitors required									
				[kvar]	[μF]	LKT 7,8-480-DL Article-No. 31-10616							

FDR: $V_N = 480 \text{ V} / 50 \text{ Hz}$

88-01985	FDR 25-480-P8	25.0	3 x 107.4	3															
88-01986	FDR 50-480-P8	50.0	3 x 214.8	6															

Article-No.	Type	Q	C	Type and quantity of the capacitors required									
				[kvar]	[μF]	LKT 4,17-525-DL Article-No. 31-10619	LKT 7,7-525-DL Article-No. 31-10621	LKT 8,33-525-DL Article-No. 31-10622					

FKD/FDR: $V_N = 525 \text{ V} / 50 \text{ Hz}$

88-01845	FKD 20-525-P8	20.0	3 x 80.5	1	2														
88-01840	FDR 25-525-P8	25.0	3 x 89.5		3														
88-01846	FDR 30-525-P8	30.0	3 x 112.7	1		3													
88-01839	FDR 50-525-P8	50.0	3 x 179.0		6														
88-01871	FDR 50-525-P8	50.0	3 x 179.0		6														

Article-No.	Type	Q	C	Type and quantity of the capacitors required									
				[kvar]	[μF]	LKT 28,2-760-DP Article-No. 31-10569	LKT 6,7-800-DP Article-No. 31-10570	LKT 26,7-800-DP Article-No. 31-10574					

FKD/FDR: $V_N = 690 \text{ V} / 50 \text{ Hz}$

88-01807	FKD 25-690-P8	25.0	3 x 55.3		1	2													
88-01912	FDR 50-690-P8	50.0	3 x 103.1	4															

Technical Annex

Guide to selection: Harmonic Filter Reactors → Capacitors

Detuning factor $p = 14\%$

Article-No.	Type	Q	C	Type and quantity of the capacitors required																
				LKT 10-400-DP Article-No. 31-10380	LKT 9,3-400-DL Article-No. 31-10602	LKT 12,5-400-DP Article-No. 31-10502														
		[kvar]	[μ F]																	

FDR: $V_N = 230\text{ V} / 50\text{ Hz}$

88-02020	FDR 15-230-P1	15.0	3 x 260.3	3	1															
88-01868	FDR 30-230-P1	30.0	3 x 519.9	4		3														

Article-No.	Type	Q	C	Type and quantity of the capacitors required																
				LKT 3,6-480-DL Article-No. 31-10613	LKT 7,8-480-DL Article-No. 31-10616	LKT 7,6-440-DL Article-No. 31-10608	LKT 12,5-525-DP Article-No. 31-10516	LKT 9,1-440-DL Article-No. 31-10387	LKT 12,1-440-DL Article-No. 31-10610	LKT 12,5-480-DP Article-No. 31-10390										
		[kvar]	[μ F]																	

FDR: $V_N = 400\text{ V} / 50\text{ Hz}$

88-01834	FDR 3,13-400-P1	3.13	3 x 16.6	1																
88-02186	FDR 6,25-400-P1	6.25	3 x 35.9		1															
88-01695	FDR 10-400-P1	10.0	3 x 59.8									1								
88-01168	FDR 12.5-400-P1	12.5	3 x 71.4		2															
88-02187	FDR 15-400-P1	15.0	3 x 89.6			1	1													
88-02177	FDR 16,7-400-P1	16.7	3 x 95.8				2													
88-01038	FDR 20-400-P1	20.0	3 x 113.1										2							
88-01171	FDR 25-400-P1	25.0	3 x 142.8				3													
88-01039	FDR 30-400-P1	30.0	3 x 174.3										3							
88-01925	FDR 33,3-400-P1	33.3	3 x 190.7								2	1								
88-02176	FDR 37,5-400-P1	37.5	3 x 214.2					2					2							
88-02175	FDR 40-400-P1	40.0	3 x 232.4											4						
88-02174	FDR 50-400-P1	50.0	3 x 285.6												5					

Article-No.	Type	Q	C	Type and quantity of the capacitors required																
				LKT 7,2-480-DL Article-No. 31-10615																
		[kvar]	[μ F]																	

FDR: $V_N = 415\text{ V} / 50\text{ Hz}$

88-01956	FDR 25-415-P1	25.0	3 x 132.6	4																
88-01957	FDR 50-415-P1	50.0	3 x 265.2	8																

6

Technical Annex

Guide to selection: Harmonic Filter Reactors → Capacitors

Article- No.	Type	Q	C	Type and quantity of the capacitors required									
				[kvar]	[μF]	LKT 7,7-525-DL Article-No. 31-10621	LKT 12,5-525-DP Article-No. 31-10516						

FDR: $V_N = 440 \text{ V} / 50 \text{ Hz}$

88-02041	FDR 25-440-P1	25.0	3 x 118.0	4														
88-02007	FDR 50-440-P1	50.0	3 x 240.5		5													

Article- No.	Type	Q	C	Type and quantity of the capacitors required									
				[kvar]	[μF]	LKT 15-690-DP Article-No. 31-10563							

FDR: $V_N = 480 \text{ V} / 50 \text{ Hz}$

88-02143	FDR 25-480-P1	25.0	3 x 100.2	3														
88-02144	FDR 50-480-P1	50.0	3 x 199.3	6														

Article- No.	Type	Q	C	Type and quantity of the capacitors required									
				[kvar]	[μF]	LKT 5,9-525-DL Article-No. 31-10620	LKT 7,7-525-DL Article-No. 31-10621	LKT 8,33-525-DL Article-No. 31-10622					

FDR: $V_N = 525 \text{ V} / 50 \text{ Hz}$

88-02039	FDR 12,5-525-P1	12.5	3 x 45.4	2														
88-01960	FDR 25-525-P1	25.0	3 x 84.4	1	1	1												
88-01900	FDR 50-525-P1	50.0	3 x 168.8	2	2	2												

Technical Annex

Guide to selection: Harmonic Filter Reactors → Capacitors

Article- No.	Type	Q	C	Type and quantity of the capacitors required									
				LKT 4,8-480-EP Article-No. 31-10515	LKT 6-480-EP Article-No. 31-10514	LKT 8,33-525-EP Article-No. 31-10385	LKT 3,6-480-EP Article-No. 31-10531						

FDR: $V_N = 690 \text{ V} / 50 \text{ Hz}$

88-02122	FDR 12,5-690-P1	12.5	3 x 22.1	3														
88-02120	FDR 20-690-P1	20.0	3 x 38.7	3			3											
88-01842	FDR 25-690-P1	25.0	3 x 50.0	3	3													
88-02257	FDR 50-690-P1	50.0	3 x 99.9			9												

Technical Annex

Guide to selection: Harmonic Filter Reactors → Capacitors



POWER QUALITY

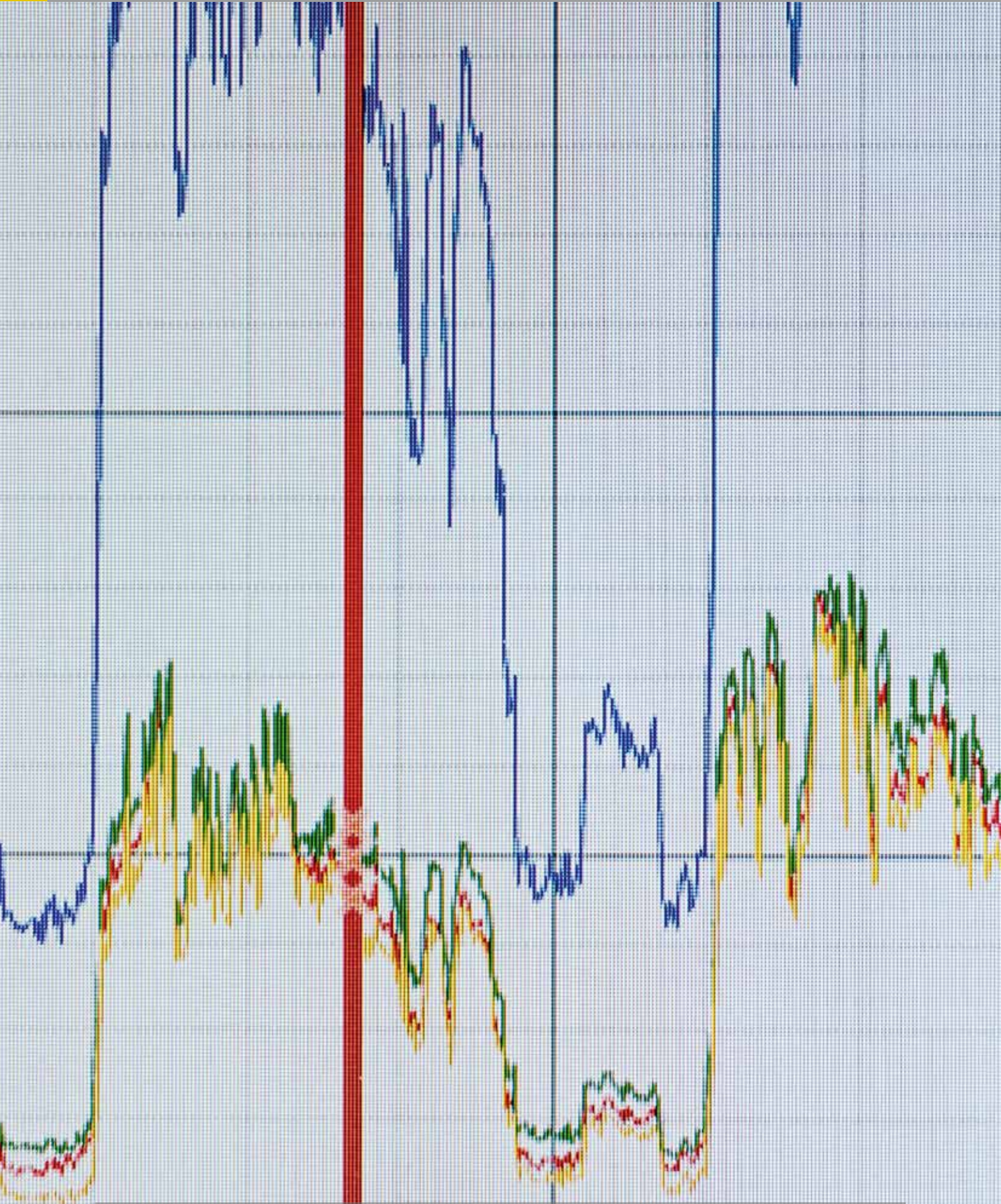

Dynamic Power Factor Correction Systems

Page 154



1

Passive Filters

Page 162



2

Active Filters

Page 166



3

Mains Monitoring

Page 194



4

Dynamic Power Factor Correction Systems

Dynamic Power Factor Correction Systems in sheet steel cabinets

Page 155

Dynamic Capacitor Modules – detuned

Page 159

Dynamic Power Factor Correction Systems

Dynamic Power Factor Correction Systems in sheet steel cabinets



LSFC-E

Dynamic Power Factor Correction Systems in sheet steel cabinets

The SBS dynamic Power Factor Correction System from FRAKO switches without delay at the next voltage zero at the thyristor switch and thus avoids any peak inrush current. Wear-free switching. The solid-state switches function without any problems even when the capacitors are not discharged and without causing peak inrush currents.

Description

The FRAKO LSFC-E Dynamic Power Factor Correction System provides switching of the capacitor stages with complete elimination of contact wear and network perturbation.

With the RM 2012 fast-acting control relay systems of the LSFC-E series are used in low voltage networks:

- with low short-circuit capacities where disruptions occur when large consumers are switched on
- where a fast-acting Power Factor Correction System and a large number of switching cycles are necessary
- where Power Factor Correction is required for only a few supply cycles at a time

Power Range

LSFC-E: 100 to 300 kvar

Construction

Sheet steel cabinet with door and lifting lugs. Ventilation via air inlet filter in the cabinet door and electric fan. Modular construction combining up to three type C-E capacitor-reactor modules.

The components comprise:

- Self-healing LKT type power capacitors with low loss self-healing dielectric made from segmented metallised polypropylene film. Filled with a PCB-free filler. With discharge resistors, as per EN 60831-1 and -2 as well as IEC 60831-1 and -2
- Electronic switching assemblies designed for 100 % operating time
- Fuselinks, 3-pole, size NH00
- Busbar system
- Control terminal strip with control circuit fuse and thermal switch
- The basic units are equipped with an RM 9606 Reactive Power Control Relay with reaction times about 5 seconds. All systems can also be supplied with EMR 1100 S, EMR 1100 or RM 2012 Control Relays
- Fan, air inlet filter and temperature controller

Dynamic Power Factor Correction Systems

Dynamic Power Factor Correction Systems in sheet steel cabinets

- Low-loss Harmonic Filter Reactors with thermal trip switch for the following series resonance frequencies:

Version	Resonance frequency	Detuning factor	For mains with utility audio frequency ¹⁾
P1	134 Hz	p = 14 %	≥ 166 Hz
P8	177 Hz	p = 8 %	≥ 217 Hz
P7	189 Hz	p = 7 %	≥ 228 Hz

¹⁾ Utility company specifications inconsistent with the above must be taken into account.

In addition, also note version specifications given in our Manual of Power Factor Correction.

Installation Site

The place of installation must comply with the requirements of the ingress protection and ambient temperature concerned.

Regulations

For installation and connection of Power Factor Correction Capacitors in Germany the following regulations must be complied with: VDE 0100, VDE 0105, VDE 0560 Part 46 and VDE 0106 Part 100 (German Association of Electrical Engineers). In other countries the equivalent local regulations must be followed.

Connection

The power supply cable enters the bottom of the cabinet through a sliding gland plate and a cable clamp rail, and is connected directly to the busbar system. The control cables are connected to the terminal strip provided for them.

System Expansion

The easy-to-maintain design simplifies the task of extending existing installations with less than three modules in one cabinet at a later date. It is also always possible to extend existing systems by installing an additional cabinet, type LSFCZ-E (extension unit without control relays).

Accessories / Options

- PFC-12TR-1 fast-acting Reactive Power Control Relay with reaction times of 20 to 40 ms (order code -500- or -501-; see chapter Power Factor Control Relays) instead of a PQC Relay
- LV HBC switch-disconnectors instead of LV HBC fuselinks for group overcurrent protection
- Customized colour to specified RAL standard
- Additional floor standing base (height: 100 or 200 mm), not fitted
- System installation in cabinet provided free issue by customer (types on request)

Technical Data

Enclosure	Sheet steel cabinet with internal fan at top, door right hinged
Rated voltage	400 V / 50 Hz
Rated capacitor voltage	440 V / 50 Hz (-P8, -P7, -P5) 480 V / 50 Hz (-P1)
Ingress protection	IP20 or IP41 per EN 60529
Ambient temperature	-5 °C to +40 °C as per VDE 0660 Part 500
Relative humidity	Max. 90 %, no condensation
Discharge	With discharge resistors acc. to VDE 0560 Part 46
Cabinet colour	RAL 7035
Standards	EN 60831-1 and -2 IEC 60831-1 and -2 EN 61921 IEC 61921 EN 61439-1 and -2 IEC 61439-1 and 2

Important Notes

For further information on power factor correction and harmonics please refer to our "Manual of Power Factor Correction".

FRAKO systems are designed for connecting 5 core cables. If a 4-core cable is used, a jumper must be fitted to connect PE and N, or a control transformer must be installed.

Dynamic Power Factor Correction Systems

Dynamic Power Factor Correction Systems in sheet steel cabinets

Version: P1 (Detuning factor p = 14 %)

Article-No.	Type	Rated power [kvar]	Stage power [kvar]	Switching sequence	Dimensions			Weight (gross) approx. [kg]	Protection IP
					Width [mm]	Height [mm]	Depth [mm]		

Power Factor Correction Systems in sheet steel cabinets (width = 800 mm), rated mains voltage: 400 V / 50 Hz

Type series: LSFC ...-P1-E

34-22804	LSFC 200-25-23-400-86-620-P1-E	200	25	1:1:2:2:2	800	2110	600	533	41
34-22805	LSFC 200-50-4-400-86-620-P1-E	200	50	1:1:1:1	800	2110	600	526	41
34-22806	LSFC 225-25-14-400-86-620-P1-E	225	25	1:2:2:2:2	800	2110	600	552	41
34-22807	LSFC 250-25-24-400-86-620-P1-E	250	25	1:1:2:2:2:2	800	2110	600	580	41
34-22808	LSFC 250-50-5-400-86-620-P1-E	250	50	1:1:1:1:1	800	2110	600	573	41
34-22809	LSFC 275-25-15-400-86-620-P1-E	275	25	1:2:2:2:2:2	800	2110	600	632	41
34-22810	LSFC 300-50-6-400-86-620-P1-E	300	50	1:1:1:1:1:1	800	2110	600	653	41

Power Factor Correction Systems, extension units in sheet steel cabinets (width = 800 mm), rated mains voltage: 400 V / 50 Hz

Type series: LSFCZ ...-P1-E

34-16652	LSFCZ 100-50-2-400-86-P1-E	100	50	1:1	800	2110	600	246	41
34-16653	LSFCZ 150-50-3-400-86-P1-E	150	50	1:1:1	800	2110	600	442	41
34-16654	LSFCZ 200-50-4-400-86-P1-E	200	50	1:1:1:1	800	2110	600	508	41
34-16655	LSFCZ 250-50-5-400-86-P1-E	250	50	1:1:1:1:1	800	2110	600	548	41
34-16656	LSFCZ 300-50-6-400-86-P1-E	300	50	1:1:1:1:1:1	800	2110	600	628	41

Other rated voltages, frequencies and power ratings on request

Recommended supply lead cross sections: please refer to the technical annex (page 137 ff.)

Version: P7 (Detuning factor p = 7 %)

Article-No.	Type	Rated power [kvar]	Stage power [kvar]	Switching sequence	Dimensions			Weight (gross) approx. [kg]	Protection IP
					Width [mm]	Height [mm]	Depth [mm]		

Power Factor Correction Systems in sheet steel cabinets (width = 600 mm), rated mains voltage: 400 V / 50 Hz

Type series: LSFC ...-P7-E

34-22811	LSFC 200-25-23-400-85-620-P7-E	200	25	1:1:2:2:2	800	2000	500	*	20
34-22812	LSFC 200-50-4-400-85-620-P7-E	200	50	1:1:1:1	800	2000	500	*	20
34-22813	LSFC 225-25-14-400-85-620-P7-E	225	25	1:2:2:2:2	800	2000	500	*	20
34-22814	LSFC 250-25-24-400-85-620-P7-E	250	25	1:1:2:2:2:2	800	2000	500	*	20
34-22815	LSFC 250-50-5-400-85-620-P7-E	250	50	1:1:1:1:1	800	2000	500	*	20
34-22816	LSFC 275-25-15-400-85-620-P7-E	275	25	1:2:2:2:2:2	800	2000	500	*	20
34-22817	LSFC 300-50-6-400-85-620-P7-E	300	50	1:1:1:1:1:1	800	2000	500	*	20

Power Factor Correction Systems, extension units in sheet steel cabinets (width = 600 mm), rated mains voltage: 400 V / 50 Hz

Type series: LSFCZ ...-P7-E

34-16244	LSFCZ 100-50-2-400-85-P7-E	100	50	1:1	800	2000	500	*	20
34-16245	LSFCZ 150-50-3-400-85-P7-E	150	50	1:1:1	800	2000	500	*	20
34-16246	LSFCZ 200-50-4-400-85-P7-E	200	50	1:1:1:1	800	2000	500	*	20
34-16247	LSFCZ 250-50-5-400-85-P7-E	250	50	1:1:1:1:1	800	2000	500	*	20
34-16248	LSFCZ 300-50-6-400-85-P7-E	300	50	1:1:1:1:1:1	800	2000	500	*	20

Other rated voltages, frequencies and power ratings on request

Recommended supply lead cross sections: please refer to the technical annex (page 137 ff.)

* on request

For options and accessory equipment for PFC Systems, module rails, ordering examples and dimensional drawings see page 87 ff.

Dimensions

Dynamic Power Factor Correction Systems

Dynamic Power Factor Correction Systems in sheet steel cabinets

1

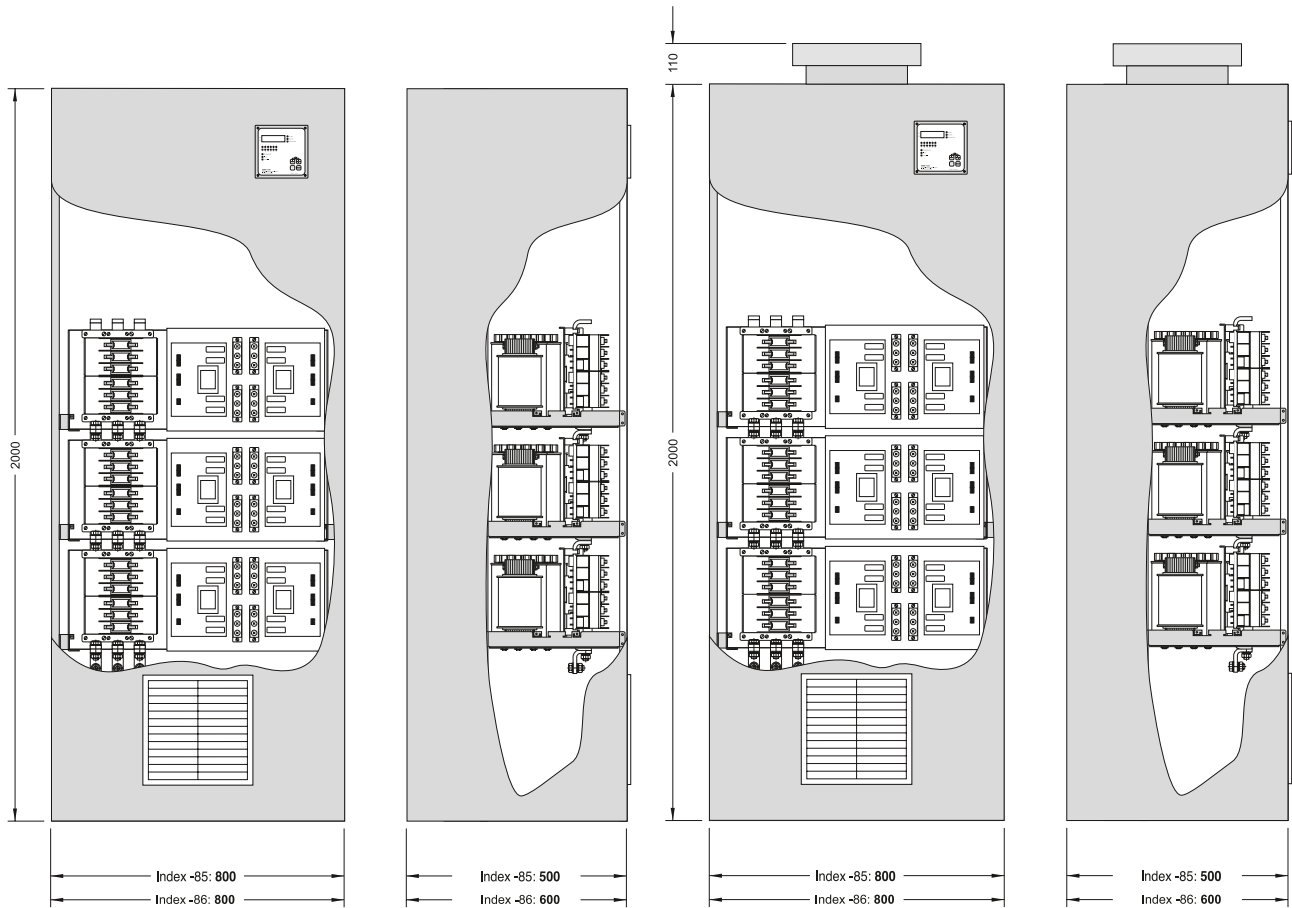

Dimensional drawing LSFC-E (100 to 300 kvar)

All dimensions in mm

Dynamic Power Factor Correction Systems

Dynamic Capacitor Modules – detuned



C84D-P-E / C85D-P-E / C86D-P-E Dynamic Capacitor Modules – detuned

FRAKO's dynamic Capacitor Modules are suitable for installation in standard switchgear systems. Avoiding of inrush current peaks through instantaneous zero-cross switching – therefore free of wear switching even when capacitors are not discharged.

- Power Range: 25 to 100 kvar per module
- Compact design - up to 300 kvar per cabinet
- Ideal for mounting in all common switchgear systems
- Easy and quick mounting with multifunctional rails
- Power Factor Correction Capacitors LKT dry-type with four safety features

Application Recommendations

Capacitor modules type C84D-P-E, C85D-P-E and C86D-P-E are suitable for installation in standard switchgear systems. Additional mounting rails for all common switchgear systems:

- W = 800 mm, T = 400, 500, 600 mm
- allow an easy and quick installation of complex Power Factor Correction Systems.

Suitable for supply networks with harmonic distortion according to EN 61000-2-4 class 2.

Available in the following versions:

Version	Detuning factor	Resonance frequency
P1	p = 14 %	134 Hz
P5	p = 5.67 %	210 Hz
P7	p = 7 %	189 Hz
P8	p = 8 %	177 Hz

Dynamic Power Factor Correction Systems

Dynamic Capacitor Modules – detuned

1

Power Range

Compact compensation module ideal for mounting in switchgear systems:

- 25 to 100 kvar

Construction

Sheet steel chassis with mounted power capacitors, electronic switches for 100 % duty cycle and fuses - ideal for mounting in all common switchgear systems.

The module consists of:

- Self-healing LKT type power capacitors with low-loss self-healing dielectric made from segmented metallised polypropylene film. Filled with a PCB-free filler. With discharge resistors, as per EN 60831-1 and -2 as well as IEC 60831-1 and -2
- With electronic switches for 100 % duty cycle
- Low-loss Harmonic Filter Reactors with temperature switches
- Busbar system with bus-mounting fuse base, 3-pole, size NH 00
- Control circuit with female connector (wired connector for connection with terminal strip incl.)

Installation Site

The place of installation must comply with the requirements of the ingress protection and ambient temperature concerned.

Regulations

For installation and connection of Power Factor Correction Capacitors in Germany the following regulations must be complied with: VDE 0100, VDE 0105, VDE 0560 Part 46 and VDE 0106 Part 100 (German Association of Electrical Engineers). In other countries the equivalent local regulations must be followed.

Installation

Specific module rails are required for installation in the switchgear system. Those module rails are available for all common switchgear systems and can be supplied as an optional accessory.

Connection

The network connection can be done either vertically or horizontally. For the horizontal connection one has to connect the cables equipped with the cable lugs to the busbar by using the M12 screws.

A bus connection bracket CU AW-1 for vertical connection is available as an option.

Additional modules can be connected directly via the busbar system.

Technical Data

Design

Sheet steel chassis for installation in switchgear cabinets
C6xD... for cabinets (width = 600 mm)
C8xD... for cabinets (width = 800 mm)

Rated voltage 400 V/50 Hz

Rated voltage of capacitors 440 V/50 Hz (-P5 to -P8)
480 V/50 Hz (-P1)

Ambient temperature -5 °C to +60 °C

Humidity Max. 90 %, no condensation

Standards EN 60831-1 and -2
IEC 60831-1 and -2
EN 61921
IEC 61921
EN 61439-1 and -2
IEC 61439-1 and 2

Important Notes

For further information on power factor correction and harmonics please refer to our "Manual of Power Factor Correction".

Dynamic Power Factor Correction Systems

Dynamic Capacitor Modules – detuned

Version: P1 (Detuning factor p = 14 %)

Article- No.	Type	Rated power [kvar]	Step power [kvar]	Switching sequence	Dimensions			Weight (gross) approx. [kg]	Protection IP
					Width [mm]	Height [mm]	Depth [mm]		

Capacitor Modules for installation in switchgear systems with a width of 800 mm, rated mains voltage: 400 V / 50 Hz

Type series: C8xD ...-P1-E

34-64857	C84D 25-25-1-400/480-84-P1-E	25	25	1	700	300	350	58	00
34-65016	C85D 37,5-12,5-11-400/480-85- P1-E	37.5	12.5	1:2	700	300	450	*	00
34-65015	C85D 50-25-2-400/480-85-P1-E	50	25	1:1	700	300	450	*	00
34-64886	C84D 50-50-1-400/480-84-P1-E	50	50	1	700	300	350	*	00
34-64376	C85D 75-25-11-400/480-85-P1-E	75	25	1:2	700	300	450	*	00
34-65012	C86D 100-50-2-400/480-86-P1-E	100	50	1:1	700	300	550	*	00

Other rated voltages, frequencies and power ratings on request

Recommended supply lead cross sections: please refer to the technical annex (page 137 ff.)

Version: P7 (Detuning factor p = 7 %)

Article- No.	Type	Rated power [kvar]	Step power [kvar]	Switching sequence	Dimensions			Weight (gross) approx. [kg]	Protection IP
					Width [mm]	Height [mm]	Depth [mm]		

Capacitor Modules for installation in switchgear systems with a width of 800 mm, rated mains voltage: 400 V / 50 Hz

Type series: C6xD ...-P7-E

34-64028	C84D 25-25-1-400/440-84-P7-E	25	25	1	700	300	350	*	00
34-64061	C84D 37,5-12,5-11-400/440-84-P7-E	37.5	12.5	1:2	700	300	350	*	00
34-64029	C84D 50-25-2-400/440-84-P7-E	50	25	1:1	700	300	350	*	00
34-64030	C84D 50-50-1-400/440-84-P7-E	50	50	1	700	300	350	*	00
34-64031	C85D 75-25-11-400/440-85-P7-E	75	25	1:2	700	300	450	*	00
34-64032	C85D 100-50-2-400/440-85-P7-E	100	50	1:1	700	300	450	97	00

Other rated voltages, frequencies and power ratings on request

Recommended supply lead cross sections: please refer to the technical annex (page 137 ff.)

* on request

For options and accessory equipment for PFC Systems on mounting plates and ordering examples see page 87 ff.

Passive Filters

2

Passive Filter Systems in sheet steel cabinets

Page 163

Passive Filters

Passive Filter Systems in sheet steel cabinets



2

LSFC-P4

Passive Filter Systems in sheet steel cabinets

Passive Filter Systems in sheet steel cabinets for low voltage networks heavily contaminated with harmonics but with a relatively low reactive power demand. Customized filter circuits with intelligent control systems are a reliable means of reducing current and voltage harmonics and offer an excellent cost-benefit ratio.

Passive Filter Systems for low voltage networks heavily contaminated with harmonics but needing relatively little reactive power.

- Power range up to 460 A_{rms} per cabinet unit
- Modular construction in freestanding sheet steel cabinet
- LKT power capacitors with dry design and fourfold safety features
- Highly linear filter reactors
- Tuning frequency (detuning factor) individually adjustable for specific network
- Control and self-monitoring system individually configurable via harmonic voltage and filter current, making measurement by external current transformer unnecessary
- Permanent network monitoring by continuous network analysis
- Complete system ready to install

The essential differences between a conventional Power Factor Correction System and a Passive Filter System:

Power Factor Correction System (detuning factor 7 % to 14 %):

- Installation where a large reactive power demand exists but
- Harmonic levels are 'normal' (as per EN 50160 or EN 61000-2-4, Class 2)
- Stages switched in and out depending on power factor ($\cos \varphi$)

Passive Filter System (adjusted detuning factor):

- Installation where harmonic levels are 'high' (as per EN 61000-2-4, Class 3 or higher) but
- Reactive power demand is low
- Stages switched in and out depending on voltage and current harmonic levels

Passive Filters

Passive Filter System in sheet steel cabinets

Design and operating principle:

The power circuit of the Passive Filter System consists of power capacitors in series with highly linear filter reactors, the power rating and series resonant frequency of the individual filter circuit stages being carefully adjusted and monitored to suit the characteristics of the particular network.

The system includes the following components:

- Self-healing LKT-type power capacitors with low-loss dielectric – made from segmented metallised polypropylene film – overpressure disconnection, solder-free design and PCB-free filler material;
- LKT series with discharge resistors to EN 60831-1 and -2 / IEC 60831-1 and -2
- Heavy duty capacitor contactors with precharging contacts
- Highly linear filter reactors with thermal trip switch
- Fuse links, 3-pole, size NH00
- Control terminal strip with control circuit fuse and thermal trip contact
- EM-PQ 2300 Power Quality Analyzer as intelligent control unit
- Thermostat-controlled electric cooling fan or natural ventilation

The capacitor stages are switched in by the control unit according to appropriate voltage parameters, such as:

- The levels of individual harmonics or
- The THDv (geometric sum of all voltage harmonics)

The capacitor stages are switched out according to current parameters measured in the filter system, such as:

- The levels of individual harmonics or
- The THDi (geometric sum of all current harmonics)

The control unit is also able to monitor the network for compliance with the relevant power quality standards and send an alarm signal via an Ethernet interface if the monitored parameters go beyond set limits!

Options:

- Power capacitors with up to 909 V overvoltage capacity (continuous)
- Design with modules tuned for several different harmonics – with interlock circuit and monitoring for reliable operation of the complete system
- Compensation circuits for the identification and monitoring of unbalance
- Automatic resonance detuning
- Installation possible in a wide variety of cabinet systems

Passive Filters

Passive Filter Systems in sheet steel cabinets

Dimensions

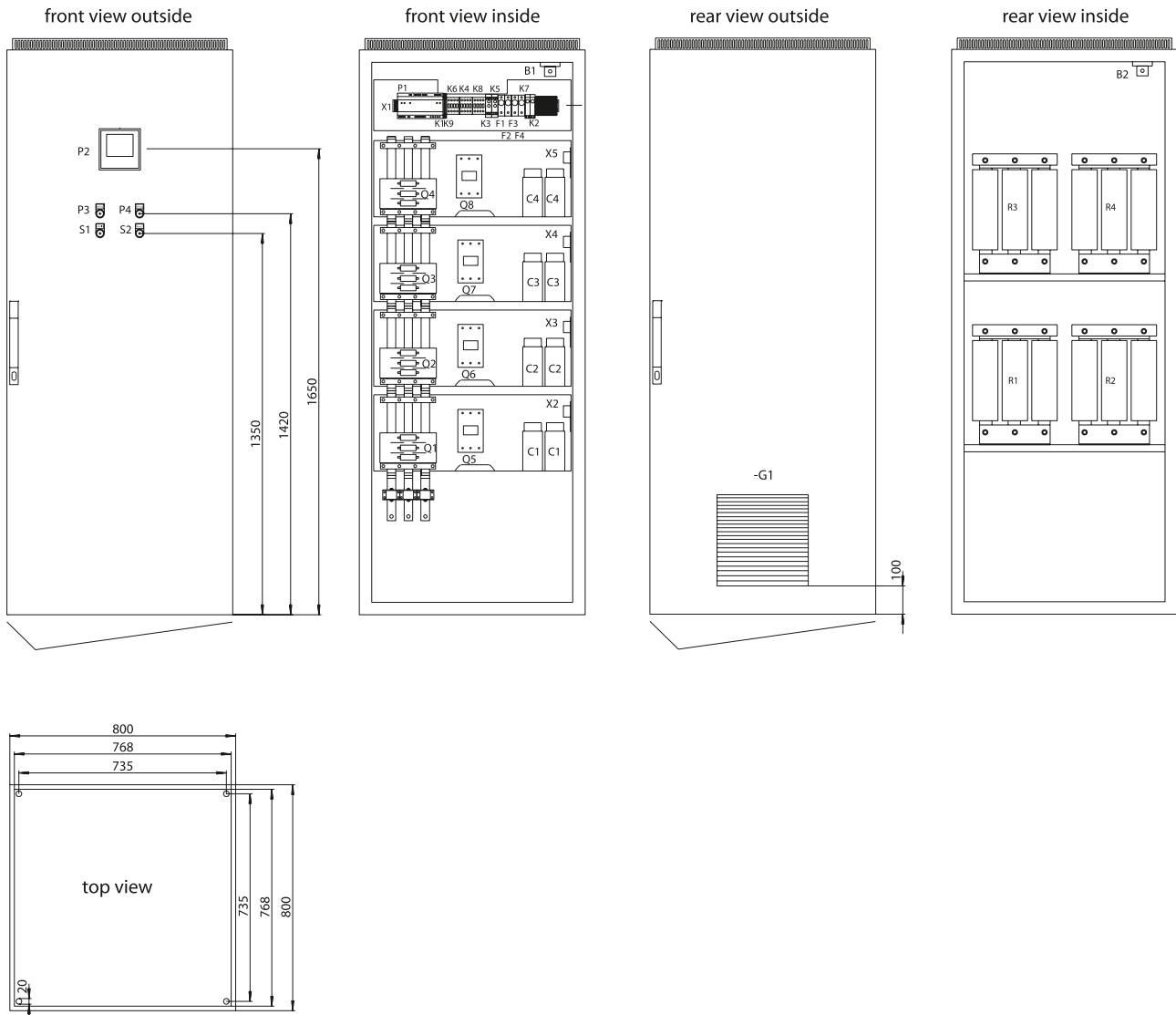

All dimensions in mm

2

Active Filters

OSF EZ-Series, OSFS

Page 167

OSF EZ-Series

Page 169

OSFS

Page 183

Active Filters

OSF EZ-Series, OSFS



3

OSF EZ-Series, OSFS Active Filters

Active harmonic filters for three-phase low voltage networks with a neutral conductor for the compensation of harmonic currents up to the 49th harmonic, the correction of reactive power at the fundamental frequency and for balancing loads. Available in free-standing modular or compact cabinets, also available in cabinets for wall assembly.

A host of problems...

The quality of a power supply is reduced considerably by loads that generate harmonics. These can cause electronically controlled devices to fail, break down or exhibit "inexplicable malfunction".

- Sporadic upsets and defects in electronic control systems and devices
- Sporadic tripping of circuit breakers for no apparent reason
- Cables - especially transformers and induction motors - get too hot
- Motor power drops
- Power factor correction systems are overloaded
- The neutral conductor is overloaded
- Flicker in the supply network
- Disrupting effects on the medium voltage network

THE solution

If the operation of loads causing serious harmonics problems calls for an improvement of the network quality, FRAKO Active Filters should be installed.

The harmful effects of harmonics from single loads, load groups or a complete electrical system can be mitigated down to an acceptable degree, if not removed totally from the network.

OSF EZ-Series and OSFS Active Filters combine numerous advantages. They are top-of-the-range instruments hallmarked by extremely short reaction times and selective control up to the 50th harmonic, without current error or phase displacement. The degree of compensation and the control dynamics can be optimized to suit local conditions.

In addition to harmonics compensation, these filters are also suitable for extremely fast control of fundamental-frequency reactive power and for balancing asymmetrical loads. This also reduces the amount of flicker in the network.

Active Filters

OSF EZ-Series, OSFS

Essential operating principle of Active Filters

OSF EZ-Series and OSFS Active Filters are operated in parallel with the loads that generate the harmonics.

The Active Filter analyses the harmonic current caused by nonlinear loads and supplies a compensating current in phase opposition, either over the entire spectrum or with only selected harmonics targeted. The harmonic currents are therefore completely neutralized at the point of connection.

The number, size and location in the circuit of Active Filters depend on the local harmonic spectrum and the specific duties.

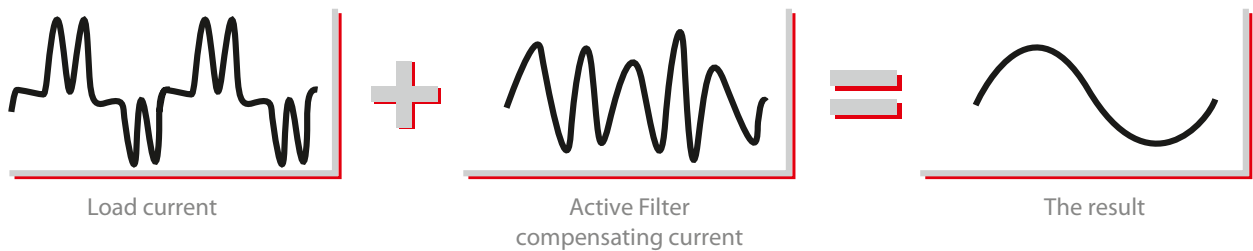

CNC machine tool

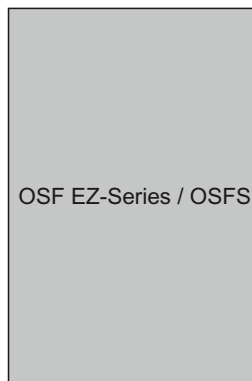

Active Filter



Transformator

	OSF EZ-Series	OSFS
Web server	•	•
Remote control	•	•
Interfaces	Ethernet (Modbus TCP)	Ethernet TCP/IP
Resonance detection	•	•
3-wire units [A]	60, 120, 180, 240, 300	75, 90, 110, 120, 130, 150, 240, 300, 360, 450
4-wire units [A]	60, 120, 180, 240, 300	100
690 V (3-wire) units [A]	-	90, 140, 180, 270, 280, 420
UL certified (3-wire) units [A]	60, 120, 180, 240, 300	90, 110, 180, 220, 270, 330
Catalogue page	Page 169 ff.	Page 183 ff.

Active Filters

OSF EZ-Series



3

OSF EZ-Series Active Filters

OSF EZ-Series – a highly dynamic Active Filter

The OSF EZ-Series offers a state-of-the-art Active Filter with resonance detection and web server functionality. The module-based solution is scalable in $I_N = 60$ A steps. The OSF EZ-Series is certified according to CE and available with 3- and 4-wire modules.

The OSF EZ-Series range

– **AS Modular cabinet:**

Freestanding cabinet with up to 5 modules

– **WS Cabinet for wall assembly:**

With up to two modules

– **KS Compact cabinet:**

With up to two modules

– **3 3-wire:**

For compensating three phases without a neutral conductor

– **4 4-wire:**

For compensating three phases and the neutral conductor

Options:

- higher-level controller

Characteristics:

- Dynamic current compensation up to the 49th harmonic
- Module-based, scalable in $I_N = 60$ A steps
- 4-wire and 3-wire solutions
- Selective harmonic compensation
- Compensation level can be adjusted individually for each harmonic
- Detection of resonances and guard function
- Flicker compensation
- Dynamic inductive and capacitive power factor correction
- Higher-level control of several units with FRAKO Power Quality Management integration
- Closed-loop or open-loop operation
- Low-loss 3-level IGBT inverter technology with d.c. link

Superior Control

Superior Control enables the user to ensure that an EZ-Series filter always operates at its best, giving a clear overview of the supply network and optimum loading of the installations.

The higher-level control and visualization system allows the system to adapt as best as possible to local conditions and all external factors. From the display of higher-level parameters, and alarms when variables go outside set limits, to active intervention by the control system – for this, data from other devices, systems or sensors, for example via Modbus TCP, can also be acquired and processed.

In addition, data can be transferred via OPC UA to other networks, such as building control or ERP systems.

The hardware and software installed for Superior Control offers all the prerequisites for an upgrade to the Supervision Service whenever desired. The Supervision Service is an all-inclusive service package for harmonic filter systems that offers peace of mind for the user. Please contact us; we would be very happy to demonstrate how we can support your maintenance and operation to the best of our ability.

Optionales Zubehör

Article-no.	Type	Consisting of:
39-22526	Superior Control „in a box“	<ul style="list-style-type: none"> • PQM 1588 with 10 system points • LTE + Router • EMVIS 3000 visualization software incl. wall-mounting case
39-22527	Superior Control „add-on“	<ul style="list-style-type: none"> • PQM 1588 with 10 system points • LTE + Router • EMVIS 3000 visualization software incl. installation material

Active Filters

OSF EZ-Series

Technical Data

OSF EZ-Series (3-wire, modular cabinet, air-cooled), 400 V

Type	OSF EZ-Series 60-400-3-AS	OSF EZ-Series 120-400-3-AS	OSF EZ-Series 180-400-3-AS	OSF EZ-Series 240-400-3-AS	OSF EZ-Series 300-400-3-AS
Article-No.	39-22534	39-22536	39-22538	39-22540	39-22542
Power rating	42 kVA	83 kVA	125 kVA	167 kVA	208 kVA
Compensating current	60 A	120 A	180 A	240 A	300 A
Rated voltage	200 V - 480 V (+/- 10 %)				
Supply frequency	47 - 63 Hz				
Number of phases	3-wire and PE				
Phase connections	3-wire without neutral conductor (TT, TN-C, TN-S, TN-C-S)				
Harmonics compensation	Individually up to the 49 th order				
Switching frequency	24 kHz				
Max. current	Limited to nominal current				
Current transformer	100:1 up to 2500:1 adjustable in 1 A steps				
Reactive power compensation cos ϕ	-0.7 up to +0.7				
Compensation of unbalance	60 A per phase/per module				
Parallel operation	up to 2 OSF EZ-Series filter cabinets				
Response time	21 μ s				
Controller topology	Digital with FFT				
Topology	3-Level IGBT				
Power loss	Standby [W]	50 per module (~ 0.1 %)			
	at max. reactive current [W]	450 per module (~ 1 %)			
	at max. harmonic current [W]	900 per module (~ 2.1 %)			
Max. required airflow	360 m ³ /h per module				
Overload current	2.5 x I _N for a maximum of 10 ms				
Noise level (1 m)	< 65 db (A)				
Altitude	2 000 m without derating				
Ambient conditions as per (EN 50178)	Relative humidity up to < 95 % non condensing, PCB are coated Temperature: Storage -25 °C up to +55 °C, 1K4 and 1K3				
Operating temperature	-10 °C to +45 °C full performance, +45 °C to +55 °C derating				
Dimensions (W x H x D) [mm]	800 x 2 160 x 605				
Weight [kg]	305	360	415	470	525
Type of protection	IP54				
Electromagnetic compatibility (EMC)	EN 61000-6-2, EN 61000-6-4, EN 61800-3 (C2)				
Safety	EN 50178, IEC 62477-1, EN 61800-3 class C2				
Conformity	CE				
Interfaces	Web server, Modbus				

Active Filters

OSF EZ-Series

Technical Data

OSF EZ-Series (4-wire, modular cabinet, air-cooled), 400 V

Type	OSF EZ-Series 60-400-4-AS	OSF EZ-Series 120-400-4-AS	OSF EZ-Series 180-400-4-AS	OSF EZ-Series 240-400-4-AS	OSF EZ-Series 300-400-4-AS
Article-No.	39-22535	39-22537	39-22539	39-22541	39-22543
Power rating	42 kVA	83 kVA	125kVA	167kVA	208 kVA
Compensating current	60 A	120 A	180 A	240 A	300 A
Compensating current in neutral conductor	180 A	360 A	540 A	720 A	900 A
Rated voltage	200 V - 415 V (+/- 10 %)				
Supply frequency	47 - 63 Hz				
Number of phases	3-wire, neutral conductor and PE				
Phase connections	3-wire with neutral conductor (TT, TN-C, TN-S, TN-C-S)				
Harmonics compensation	Individually up to the 49 th order				
Switching frequency	24 kHz				
Max. current	Limited to nominal current				
Current transformer	100:1 up to 2500:1 adjustable in 1 A steps				
Reactive power compensation cos φ	-0.7 up to +0.7				
Compensation of unbalance	60 A per phase/per module				
Parallel operation	up to 2 OSF EZ-Series filter cabinets				
Response time	21 μs				
Controller topology	Digital with FFT				
Topology	3-Level IGBT				
Power loss	Standby [W]	50 per module (~ 0.1 %)			
	at max. reactive current [W]	450 per module (~ 1 %)			
	at max. harmonic current [W]	900 per module (~ 2.1 %)			
Max. required airflow	360 m ³ /h per module				
Overload current	2.5 x I _N for a maximum of 10 ms				
Noise level (1 m)	< 65 db (A)				
Altitude	2 000 m without derating				
Ambient conditions as per (EN 50178)	Relative humidity up to < 95 % non condensing, PCB are coated Temperature: Storage -25 °C up to +55 °C, 1K4 and 1K3				
Operating temperature	-10 °C to +45 °C full performance, +45 °C to +55 °C derating				
Dimensions (W x H x D) [mm]	800 x 2 160 x 605				
Weight [kg]	305	360	415	470	525
Type of protection	IP54				
Electromagnetic compatibility (EMC)	EN 61000-6-2, EN 61000-6-4, EN 61800-3 (C2)				
Safety	EN 50178, IEC 62477-1, EN 61800-3 class C2				
Conformity	CE				
Interfaces	Web server, Modbus				

Active Filters

OSF EZ-Series

Technical Data

OSF EZ-Series (3-wire, compact cabinet, air-cooled), 400 V

Type	OSF EZ-Series 60-400-3-KS	OSF EZ-Series 120-400-3-KS
Article-No.	39-22510	39-22512
Power rating	42 kVA	83 kVA
Compensating current	60 A	120 A
Rated voltage	200 V - 480 V (+/- 10 %)	
Supply frequency	47 - 63 Hz	
Number of phases	3-wire and PE	
Phase connections	3-wire without neutral conductor (TT, TN-C, TN-S, TN-C-S)	
Harmonics compensation	individually up to the 49 th order	
Switching frequency	24 kHz	
Max. current	Limited to nominal current	
Current transformer	100:1 up to 2500:1 adjustable in 1 A steps	
Reactive power compensation $\cos \phi$	-0.7 up to +0.7	
Compensation of unbalance	60 A per phase/per module	
Parallel operation	up to 2 OSF EZ-Series filter cabinets	
Response time	21 μ s	
Controller topology	Digital with FFT	
Topology	3-Level IGBT	
Power loss	Standby [W]	50 per module (~ 0.1 %)
	at max. reactive current [W]	450 per module (~ 1 %)
	at max. harmonic current [W]	900 per module (~ 2.1 %)
Max. required airflow	360 m ³ /h per module	
Overload current	2.5 x I_N for a maximum of 10 ms	
Noise level (1 m)	< 65 db (A)	
Altitude	2 000 m without derating	
Ambient conditions as per (EN 50178)	Relative humidity up to < 95 % non-condensing, PCB are coated Temperature: Storage -25 °C up to +55 °C, 1K4 and 1K3	
Operating temperature	-10 °C to +45 °C full performance, +45 °C to +55 °C derating	
Dimensions (W x H x D) [mm]	625 x 1 225 x 264	625 x 1 225 x 520
Weight [kg]	130	207
Type of protection	IP54	
Electromagnetic compatibility (EMC)	EN 61000-6-2, EN 61000-6-4, EN 61800-3 (C2)	
Safety	EN 50178, IEC 62477-1, EN 61800-3 class C2	
Conformity	CE	
Interfaces	Web server, Modbus	

Active Filters

OSF EZ-Series

Technical Data

OSF EZ-Series (4-wire, compact cabinet, air-cooled), 400 V

Type	OSF EZ-Series 60-400-4-KS	OSF EZ-Series 120-400-4-KS
Article-No.	39-22511	39-22513
Power rating	42 kVA	83 kVA
Compensating current	60 A	120 A
Compensating current in neutral conductor	180 A	360 A
Rated voltage	200 V - 415 V (+/- 10 %)	
Supply frequency	47 - 63 Hz	
Number of phases	3-wire, neutral conductor and PE	
Phase connections	3-wire with neutral conductor (TT, TN-C, TN-S, TN-C-S)	
Harmonics compensation	individually up to the 49 th order	
Switching frequency	24 kHz	
Max. current	Limited to nominal current	
Current transformer	100:1 up to 2500:1 adjustable in 1 A steps	
Reactive power compensation cos ϕ	-0.7 up to +0.7	
Compensation of unbalance	60 A per phase/per module	
Parallel operation	up to 2 OSF EZ-Series filter cabinets	
Response time	21 μ s	
Controller topology	Digital with FFT	
Topology	3-Level IGBT	
Power loss	Standby [W]	50 per module (~ 0.1 %)
	at max. reactive current [W]	450 per module (~ 1 %)
	at max. harmonic current [W]	900 per module (~ 2.1 %)
Max. required airflow	360 m ³ /h per module	
Overload current	2.5 x I _N for a maximum of 10 ms	
Noise level (1 m)	< 65 db (A)	
Altitude	2 000 m without derating	
Ambient conditions as per (EN 50178)	Relative humidity up to < 95 % non-condensing, PCB are coated Temperature: Storage -25 °C up to +55 °C, 1K4 and 1K3	
Operating temperature	-10 °C to +45 °C full performance, +45 °C to +55 °C derating	
Dimensions (W x H x D) [mm]	625 x 1 225 x 264	625 x 1 225 x 520
Weight [kg]	130	207
Type of protection	IP54	
Electromagnetic compatibility (EMC)	EN 61000-6-2, EN 61000-6-4, EN 61800-3 (C2)	
Safety	EN 50178, IEC 62477-1, EN 61800-3 class C2	
Conformity	CE	
Interfaces	Web server, Modbus	

Active Filters

OSF EZ-Series

Technical Data

OSF EZ-Series (3 or 4-wire, compact cabinet, air-cooled), 400 V

Type	OSF EZ-Series 60-400-3-KS II	OSF EZ-Series 60-400-4-KS II
Article-No.	39-22531	39-22532
Power rating	42 kVA	42 kVA
Compensating current	60 A	60 A
Compensating current in neutral conductor	-	180 A
Expandable to 120 A by module no.	39-22518	39-22519
Type:	OSF EZ-Series 60-400-3-QM	OSF EZ-Series 60-400-4 QM
Rated voltage	200 V - 480 V (+/- 10 %)	200 V - 415 V (+/- 10 %)
Supply frequency	47 - 63 Hz	
Number of phases	3-wire and PE	3-wire, neutral conductor and PE
Phase connections	3-wire without neutral conductor (TT, TN-C, TN-S, TN-C-S)	3-wire with neutral conductor (TT, TN-C, TN-S, TN-C-S)
Harmonics compensation	individually up to the 49 th order	
Switching frequency	24 kHz	
Max. current	Limited to nominal current	
Current transformer	100:1 up to 2500:1 adjustable in 1 A steps	
Reactive power compensation cos ϕ	-0.7 up to +0.7	
Compensation of unbalance	60 A per phase/per module	
Parallel operation	up to 2 OSF EZ-Series filter cabinets	
Response time	21 μ s	
Controller topology	Digital with FFT	
Topology	3-Level IGBT	
Power loss	Standby [W]	50 per module (~ 0.1 %)
	at max. reactive current [W]	450 per module (~ 1 %)
	at max. harmonic current [W]	900 per module (~ 2.1 %)
Max. required airflow	360 m ³ /h per module	
Overload current	2.5 x I _N for a maximum of 10 ms	
Noise level (1 m)	< 65 db (A)	
Altitude	2 000 m without derating	
Ambient conditions as per (EN 50178)	Coated circuit boards	
Operating temperature	-10 °C to +45 °C full performance, +45 °C to +55 °C derating	
Dimensions (W x H x D) [mm]	625 x 1 225 x 520	
Weight [kg]	130	
Type of protection	IP54	
Electromagnetic compatibility (EMC)	EN 61000-6-2, EN 61000-6-4, EN 61800-3 (C2)	
Safety	EN 50178, IEC 62477-1, EN 61800-3 class C2	
Conformity	CE	
Interfaces	Web server, Modbus	

Active Filters

OSF EZ-Series

Technical Data

OSF EZ-Series (3-wire, cabinet for wall assembly, air-cooled), 400 V

Type	OSF EZ-Series 60-400-3-WS	OSF EZ-Series 120-400-3-WS
Article-No.	39-22514	39-22516
Power rating	42 kVA	83 kVA
Compensating current	60 A	120 A
Rated voltage	200 V - 480 V (+/- 10 %)	
Supply frequency	47 - 63 Hz	
Number of phases	3-wire and PE	
Phase connections	3-wire without neutral conductor (TT, TN-C, TN-S, TN-C-S)	
Harmonics compensation	individually up to the 49 th order	
Switching frequency	24 kHz	
Max. current	Limited to nominal current	
Current transformer	100:1 up to 2500:1 adjustable in 1 A steps	
Reactive power compensation $\cos \phi$	-0.7 up to +0.7	
Compensation of unbalance	60 A per phase/per module	
Parallel operation	up to 2 OSF EZ-Series filter cabinets	
Response time	21 μ s	
Controller topology	Digital with FFT	
Topology	3-Level IGBT	
Power loss	Standby [W]	50 per module (~ 0.1 %)
	at max. reactive current [W]	450 per module (~ 1 %)
	at max. harmonic current [W]	900 per module (~ 2.1 %)
Max. required airflow	360 m ³ /h per module	
Overload current	2.5 x I_N for a maximum of 10 ms	
Noise level (1 m)	< 65 db (A)	
Altitude	2 000 m without derating	
Ambient conditions as per (EN 50178)	Relative humidity up to < 95 % non-condensing, PCB are coated Temperature: Storage -25 °C up to +55 °C, 1K4 and 1K3	
Operating temperature	-10 °C to +45 °C full performance, +45 °C to +55 °C derating	
Dimensions (W x H x D) [mm]	504 x 980 x 292	504 x 980 x 516
Weight [kg]	91	154
Type of protection	IP20	
Electromagnetic compatibility (EMC)	EN 61000-6-2, EN 61000-6-4, EN 61800-3 (C2)	
Safety	EN 50178, IEC 62477-1, EN 61800-3 class C2	
Conformity	CE	
Interfaces	Web server, Modbus	

Active Filters

OSF EZ-Series

Technical Data

OSF EZ-Series (4-wire, cabinet for wall assembly, air-cooled), 400 V

Type	OSF EZ-Series 60-400-4-WS	OSF EZ-Series 120-400-4-WS
Article-No.	39-22515	39-22517
Power rating	42 kVA	83 kVA
Compensating current	60 A	120 A
Compensating current in neutral conductor	180 A	360 A
Rated voltage	200 V - 415 V (+/- 10 %)	
Supply frequency	47 - 63 Hz	
Number of phases	3-wire, neutral conductor and PE	
Phase connections	3-wire with neutral conductor (TT, TN-C, TN-S, TN-C-S)	
Harmonics compensation	individually up to the 49 th order	
Switching frequency	24 kHz	
Max. current	Limited to nominal current	
Current transformer	100:1 up to 2500:1 adjustable in 1 A steps	
Reactive power compensation cos φ	-0.7 up to +0.7	
Compensation of unbalance	60 A per phase/per module	
Parallel operation	up to 2 OSF EZ-Series filter cabinets	
Response time	21 μs	
Controller topology	Digital with FFT	
Topology	3-Level IGBT	
Power loss	Standby [W]	50 per module (~ 0.1 %)
	at max. reactive current [W]	450 per module (~ 1 %)
	at max. harmonic current [W]	900 per module (~ 2.1 %)
Max. required airflow	360 m ³ /h per module	
Overload current	2.5 x I _N for a maximum of 10 ms	
Noise level (1 m)	< 65 db (A)	
Altitude	2 000 m without derating	
Ambient conditions as per (EN 50178)	Relative humidity up to < 95 % non-condensing, PCB are coated Temperature: Storage -25 °C up to +55 °C, 1K4 and 1K3	
Operating temperature	-10 °C to +45 °C full performance, +45 °C to +55 °C derating	
Dimensions (W x H x D) [mm]	504 x 980 x 292	504 x 980 x 516
Weight [kg]	91	154
Type of protection	IP20	
Electromagnetic compatibility (EMC)	EN 61000-6-2, EN 61000-6-4, EN 61800-3 (C2)	
Safety	EN 50178, IEC 62477-1, EN 61800-3 class C2	
Conformity	CE	
Interfaces	Web server, Modbus	

Active Filters

OSF EZ-Series

Technical Data

OSF EZ-Series modules for retrofitting the modular enclosure and compact cabinet (3- or 4-wire systems, air-cooled), 400 V

Type	OSF EZ-Series 60-400-3-QM	OSF EZ-Series 60-400-4 QM
Article-No.	39-22518	39-22519
Power rating	42 kVA	42 kVA
Compensating current	60 A	60 A
Compensating current in neutral conductor	-	180 A
Rated voltage	200 V - 480 V (+/- 10 %)	200 V - 415 V (+/- 10 %)
Supply frequency	47 - 63 Hz	
Number of phases	3-wire and PE	3-wire, neutral conductor and PE
Phase connections	3-wire without neutral conductor (TT, TN-C, TN-S, TN-C-S)	3-wire with neutral conductor (TT, TN-C, TN-S, TN-C-S)
Harmonics compensation	individually up to the 49 th order	
Switching frequency	24 kHz	
Max. current	Limited to nominal current	
Current transformer	100:1 up to 2500:1 adjustable in 1 A steps	
Reactive power compensation cos φ	-0.7 up to +0.7	
Compensation of unbalance	60 A per phase/per module	
Parallel operation	up to 2 OSF EZ-Series filter cabinets	
Response time	21 μs	
Controller topology	Digital with FFT	
Topology	3-Level IGBT	
Power loss	Standby [W]	50 per module (~ 0.1 %)
	at max. reactive current [W]	450 per module (~ 1 %)
	at max. harmonic current [W]	900 per module (~ 2.1 %)
Max. required airflow	360 m ³ /h per module	
Overload current	2.5 x I _N for a maximum of 10 ms	
Noise level (1 m)	< 65 db (A)	
Altitude	2 000 m without derating	
Ambient conditions as per (EN 50178)	Coated circuit boards	
Operating temperature	-10 °C to +45 °C full performance, +45 °C to +55 °C derating	
Dimensions (W x H x D) [mm]	590 x 221.5 x 493.5	
Weight [kg]	55	
Type of protection	IP20	
Electromagnetic compatibility (EMC)	EN 61000-6-2, EN 61000-6-4, EN 61800-3 (C2)	
Safety	EN 50178, IEC 62477-1, EN 61800-3 class C2	
Conformity	CE	
Interfaces	Web server, Modbus	

Active Filters

OSF EZ-Series

Dimensions

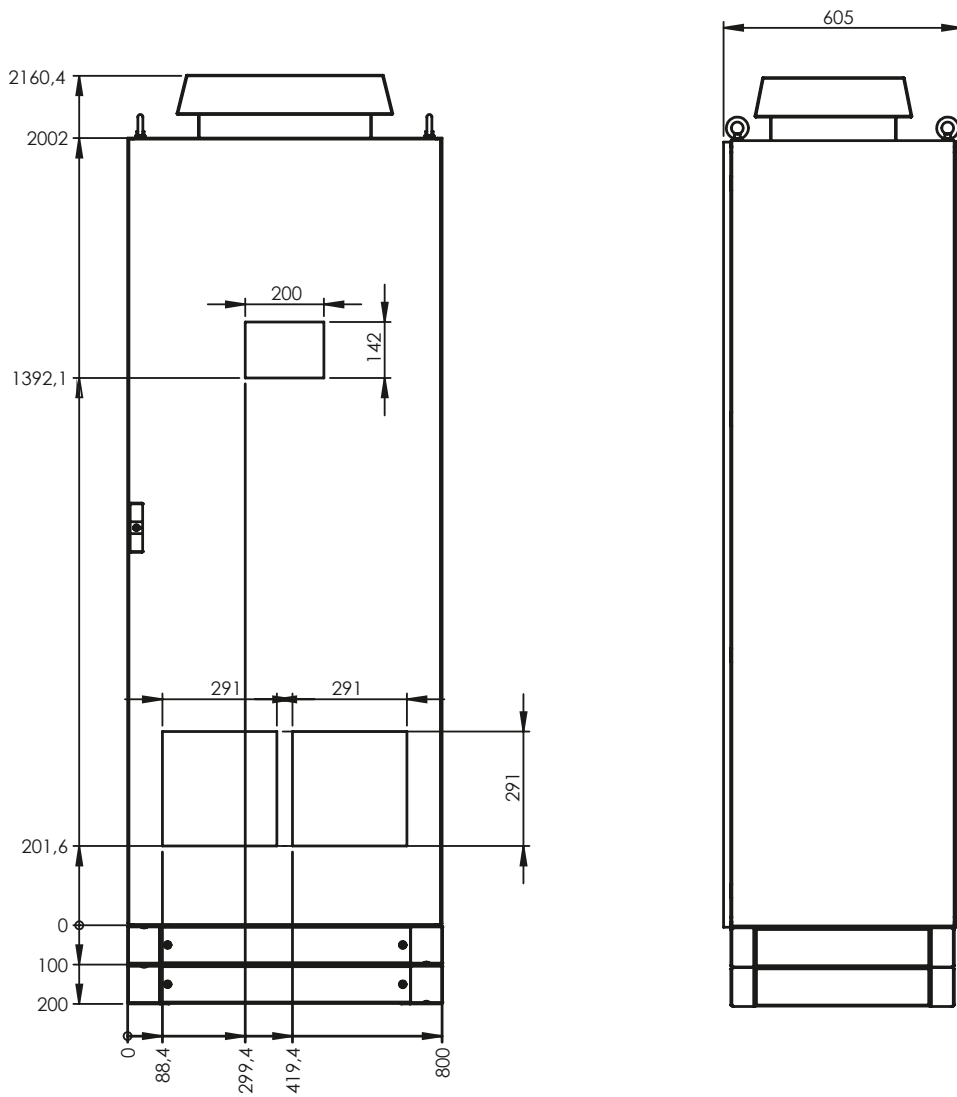

Dimensional drawing

OSF EZ-Series (3-wire, modular cabinet, air-cooled), 400 V

OSF EZ-Series (4-wire, modular cabinet, air-cooled), 400 V

All dimensions in mm

Active Filters

OSF EZ-Series

Dimensions

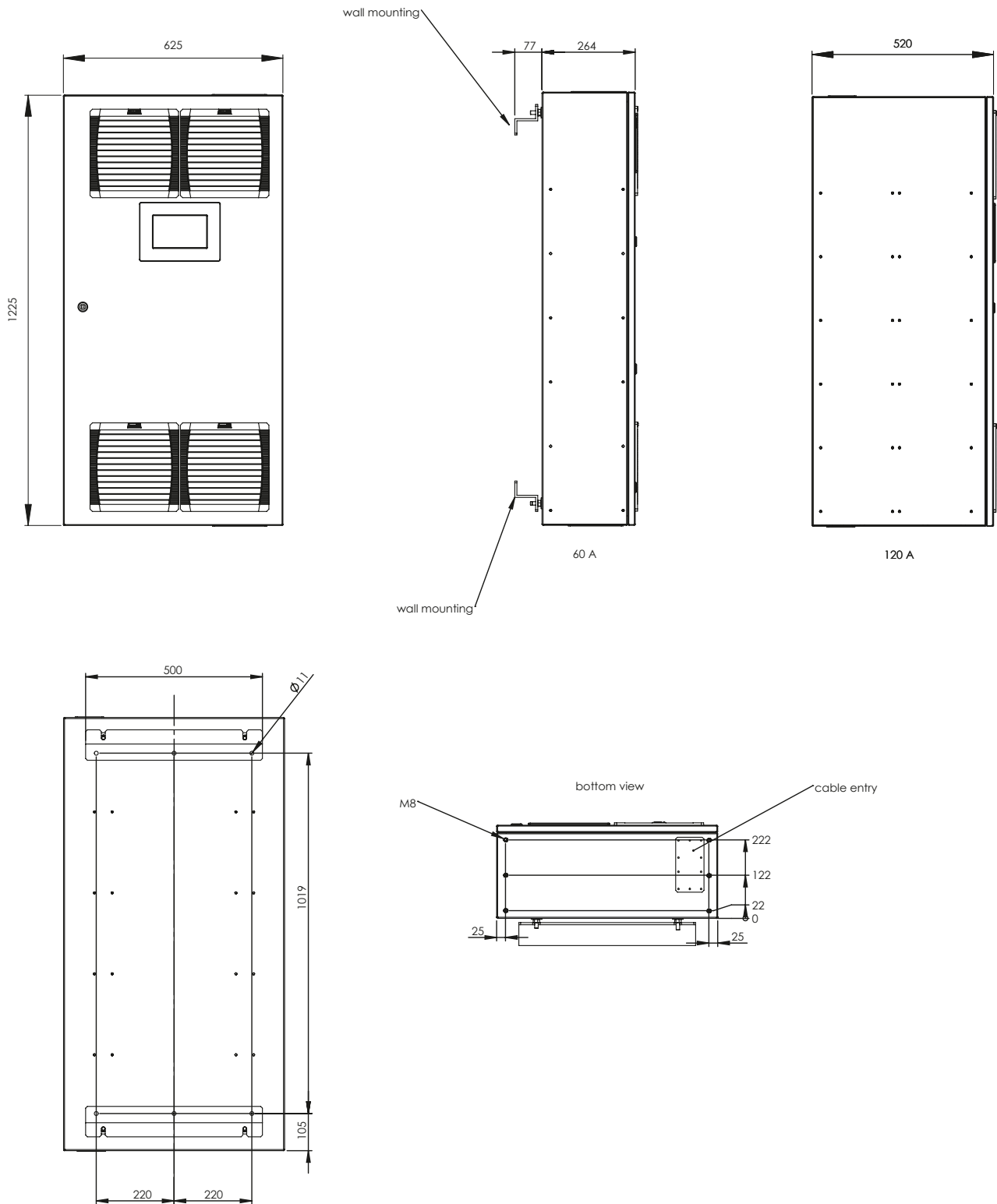

Dimensional drawing

OSF EZ-Series (3-wire, compact cabinet, air-cooled), 400 V

OSF EZ-Series (4-wire, compact cabinet, air-cooled), 400 V

All dimensions in mm

Active Filters

OSF EZ-Series

Dimensions

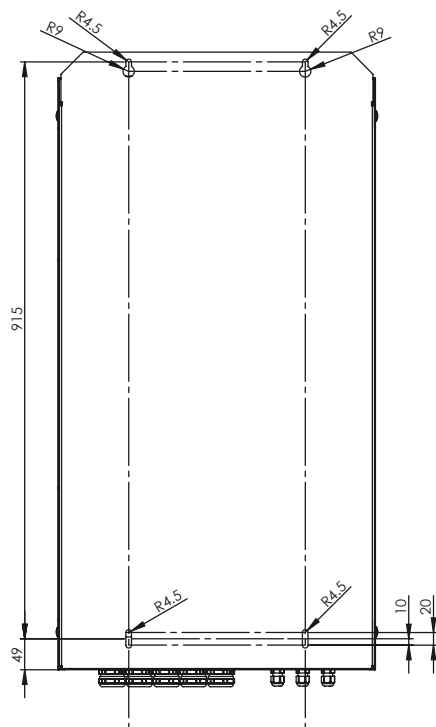
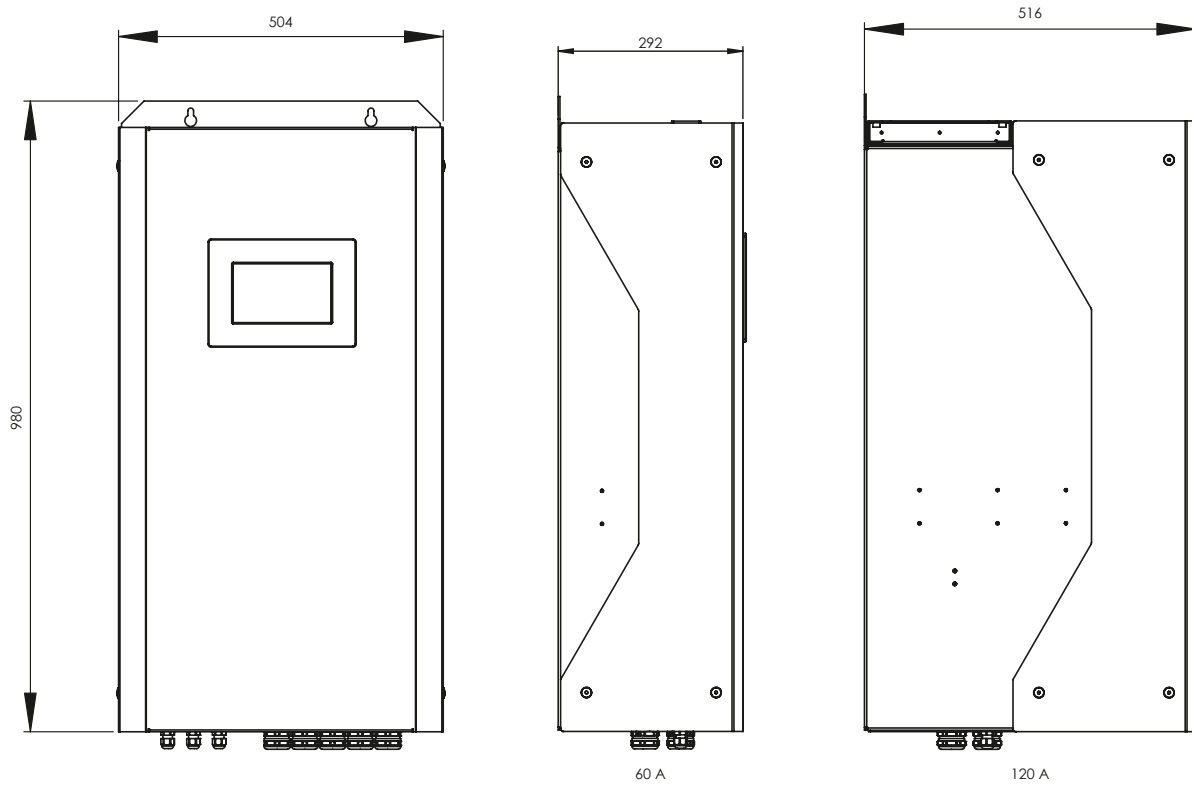

Dimensional drawing

OSF EZ-Series (3-wire, cabinet for wall assembly, air-cooled), 400 V

OSF EZ-Series (4-wire, cabinet for wall assembly, air-cooled), 400 V

All dimensions in mm

Active Filters

OSF EZ-Series

Dimensions

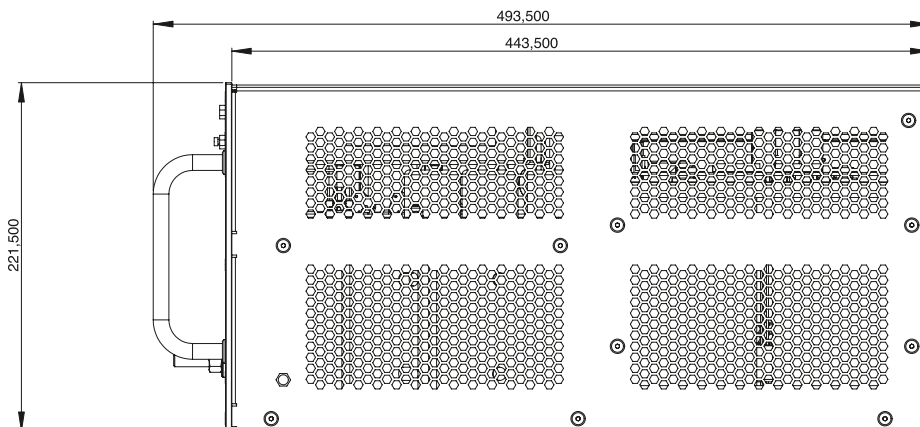
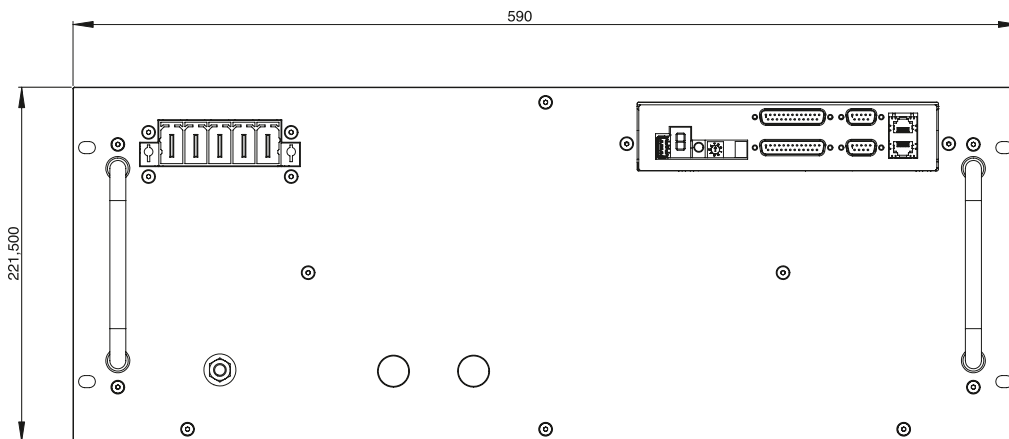
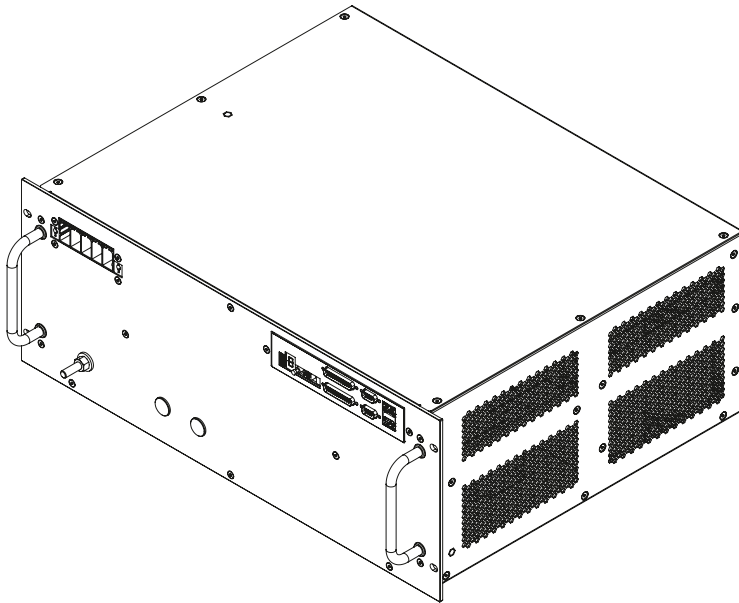

Dimensional drawing

Module OSF EZ-Series 60-400-3 QM (3-wire module)
and module OSF EZ-Series 60-400-4 QM (4-wire module)

All dimensions in mm

Active Filters

OSFS



3

OSFS Active Filters

OSFS – The highly dynamic Active Filter

OSFS units encompass a broad range of state-of-the-art Active Filters with a web server function. The product range is characterized in particular by its variety of options for high-power applications plus a large selection of 690 V units and a special filter.

The OSFS range

- **F Fixed-rating unit:**
For wall mounting
- **FS Fixed-rating unit:**
In freestanding cabinet
- **M Modular unit:**
In freestanding cabinet with up to 3 modules per cabinet
- **UL** UL certificate
 - **3 3-wire:**
For compensating three phases without a neutral conductor
 - **4 4-wire:**
For compensating three phases and the neutral conductor
- **V Voltage Controlled:**
voltage controlled Active Filter

Active Filters

OSFS

Technical Data

OSFS-F (3-wire fixed-rating unit), 400 V

Type	OSFS 30-400-3-F
Article-No.	39-22441
Power rating	21 kVA
Compensating current per phase at 50/60 Hz	30 A _{rms}
System voltage	400 V ± 10 %
Nominal frequency	50/60 Hz ± 5 %
Number of phases	3
Phase connections	3 phases without neutral conductor (TN, TT)
Harmonics compensation	Individually up to the 49th order
Degree of compensation	> 98 %
Correction of power factor cos φ	Up to 1.0
Parallel operation	OSFS Filters can be operated in parallel
Response time	< 1 ms
Power loss	< 1 000 W
Maximum air flow requirements	400 m ³ /h
Noise level	< 70 dB (A)
Ambient conditions	0 up to 95 % relative humidity, non-condensing, max. altitude: 1000 m above sea level
Operating temperature	0 to 50 °C, derating exceeding 40 °C
Dimensions (W x H x D) [mm]	230 x 2 040 x 470
Weight [kg]	50
Cabinet colour	RAL 7035 (light grey), RAL 5017 (traffic blue)
Type of protection	IP20, IP21 according to IEC 529, other ratings upon request
Environmental conditions	chemical 3C2, mechanical 3S2
Electromagnetic compatibility (EMC)	EN55011, Class B
Certificates	CE
Interfaces	Web server, Ethernet (Modbus TCP)

The units can be installed in parallel and are available as standard versions from 208 V to 480 V.

Other voltages and IP-classes on request.

Connection diagram
(example)

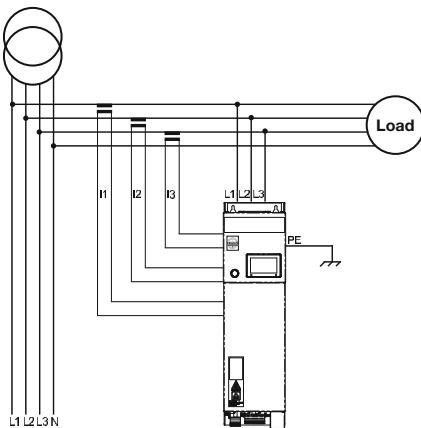

Dimensions

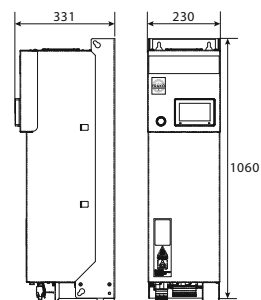

All dimensions in mm

Active Filters

OSFS

Technical Data

OSFS-F (3-wire fixed-rating unit), 400 V

Type	OSFS 50-400-3-F	OSFS 75-400-3-F	OSFS 90-400-3-F	OSFS 120-400-3-F	OSFS 150-400-3-F	OSFS 90-690-3-F
Article-No.	39-22442	39-22402	39-22400	39-22403	39-22443	39-22444
Power rating	35 kVA	52 kVA	63 kVA	83 kVA	104 kVA	108 kVA
Compensating current per phase at 50/60 Hz	50 A _{rms}	75 A _{rms}	90 A _{rms}	120 A _{rms}	150 A _{rms}	90 A _{rms}
System voltage	400 V ± 10 %					690 V ± 10 %
Nominal frequency	50/60 Hz ± 5 %					
Number of phases	3					
Phase connections	3 phases without neutral conductor (TN, TT, IT)					
Harmonics compensation	Individually up to the 49th harmonic					
Degree of compensation	> 98 %					
Correction of power factor cos φ	Up to 1.0					
Parallel operation	OSFS Filters can be operated in parallel					
Response time	< 1 ms					
Power loss	< 1 600 W	< 2 535 W	< 3 180 W	< 3 155 W	< 3 225 W	< 2 969 W
Maximum air flow requirements	600 m ³ /h					
Noise level	< 70 dB (A)					
Ambient conditions	0 up to 95 % relative humidity, non-condensing, max. altitude: 1000 m above sea level					
Operating temperature	0 to 50 °C, up to 40 °C without derating					
Dimensions (W x H x D) [mm]	230 x 2 040 x 470					
Weight [kg]	91	91	91	105	116	150
Cabinet colour	RAL 7035 (light grey), RAL 5017 (traffic blue)					
Type of protection	IP 20 according to IEC 529					
Environmental conditions	Class 3C3 (chemical), class 3S3 (mechanical)					
Electromagnetic compatibility (EMC)	EN 55011, class B					
Certificates	CE, ABS, DNV GL					
Interfaces	Web server, Ethernet (Modbus TCP)					

The units can be installed in parallel and are available as standard versions from 208 V to 480 V resp. 480 V to 690 V. Other voltages and IP-classes on request.

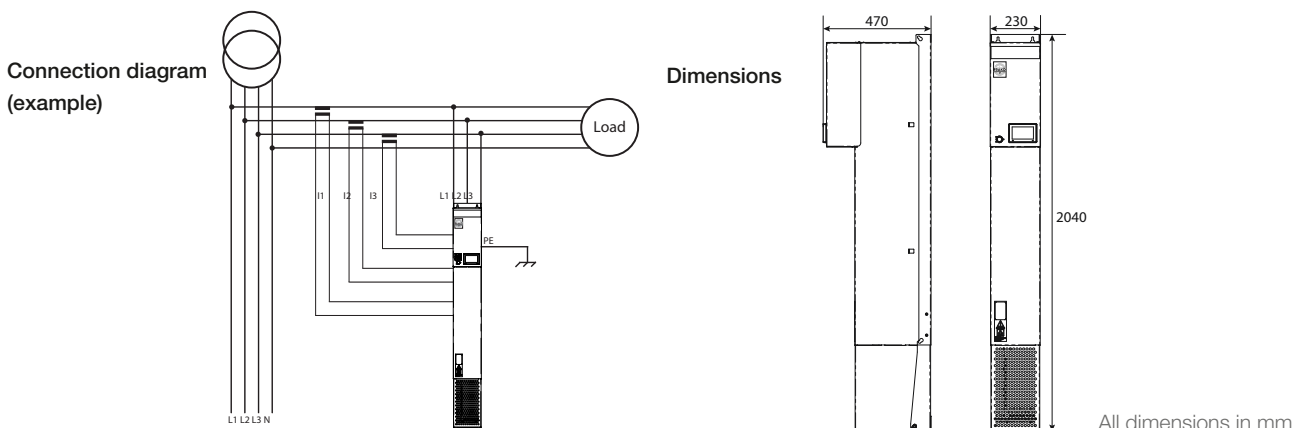

Active Filters

OSFS

Technical Data

OSFS-F (4-wire fixed rating unit), 400 V

Type	OSFS 100-400-4-F
Article-No.	39-22429
Power Rating	70 kVA
Compensating current at 50/60 Hz	phase current 100 A _{rms} / neutral current 300 A _{rms}
System voltage*	400 V ± 10 %
Nominal frequency*	50/60 Hz ± 2 %
Number of phases	3
Phase connections	3 phases with neutral conductor (TN,TT,IT)
Harmonics compensation	individual compensation up to 49th order
Degree of compensation	> 98 %
Correction of power factor cos φ	Up to 1.0
Upgradeability	OSFS Active Filters can be operated in parallel
Response time	< 1 msec
Power loss	< 2235 W
Maximum air flow requirements	600 m³/h
Noise level	< 70 dB (A)
Ambient conditions	0 up to 95 % relative humidity, non-condensing, max. altitude: 1000 m above sea level
Operating temperature	0 to 50 °C, derating exceeding 40 °C
Dimensions (W x H x D) [mm]	230 x 2 040 x 470
Weight [kg]	170
Cabinet colour	RAL 7035 (light grey), RAL 5017 (traffic blue)
Type of protection	IP20 nach IEC 529
Environmental conditions	Class 3C2 (chemical), class 3S2 (mechanical)
Electromagnetic compatibility (EMV)	EN 55011, class B
Certificates	CE
Interfaces	Web server, Ethernet (Modbus TCP)**

The units can be installed in parallel and are available as standard versions from 208 – 415 V. Other voltages and IP-classes on request.

* When ordering, please indicate the mains voltage and the mains frequency.

** further interfaces on request.

Connection diagram (example)

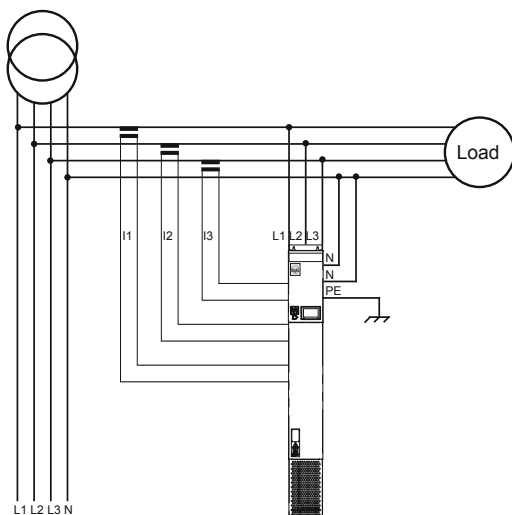

Dimensions

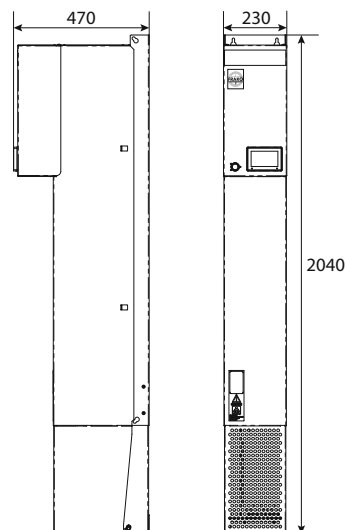

All dimensions in mm

Active Filters

OSFS

Active Filter OSFS-M in freestanding cabinet

Modern medical equipment, the latest LED technology and present-day motor control systems make the most exacting demands on power supply quality. Certain loads, however, greatly distort the supply-side waveform by generating harmonics. This situation often calls for an improvement in power quality. With the FRAKO Modular Active Filter, the distortion caused by individual loads, groups of consumers or the entire electrical installation is reduced to a tolerable level or totally eliminated from the network.

Clear benefits:

- 3 versions enable optimum adaption to the compensation requirement: 120 A, 240 A and 360 A
- Modular construction with only one control unit
- User-friendly touchscreen
- User-friendly remote service
- Current-controlled
- New: optionally also available voltage-controlled
- Voltage range: 208 V – 480 V



All dimensions in mm

Active Filters

OSFS

Technical Data

OSFS-V (3-wire fixed rating unit), 400 V

Type	OSFS 120-400-3-V2
Article-No.	39-22438
Power Rating	83 kVA
Compensating current at 50/60 Hz	120 A _{eff}
System voltage*	400 V ± 10 %
Nominal frequency*	50/60 Hz ± 2 %
Number of phases	3
Phase connections	3 phases without neutral conductor (TN, TT, IT)
Harmonics compensation	Compensation curve for harmonics and interharmonics up to 5 kHz (100 th order)
Degree of compensation	> 97 %
Correction of power factor cos φ	Up to 1.0
Upgradeability	OSFS Active Filters can be used in parallel
Response time	< 20 μs
Power loss	< 1 200 W
Maximum air flow requirements	600 m ³ /h
Noise level	< 60 dB(A)
Ambient conditions	0 up to 95 % relative humidity, non-condensing, max. altitude: 1000 m above sea level
Operating temperature	0 up to 50 °C, up to 40 °C with derating
Dimensions (W x H x D) [mm]	233 x 1653 x 470
Weight [kg]	90
Cabinet colour	Cabinet: RAL 7035 (grey), Base: RAL 7022 (dark grey)
Type of protection	IP20 to IEC 529
Environmental conditions	Class 3C3 (chemical), class 3S3 (mechanical)
Electromagnetic compatibility (EMV)	EN 55011, Class B
Certificates	CE
Interfaces	Web server, Ethernet (Modbus TCP)**

The units can be installed in parallel and are available as standard versions from 208 - 480 V. Other voltages and IP-classes on request.

* When ordering, please indicate the mains voltage and the mains frequency.

** further interfaces on request.

Connection diagram (example)

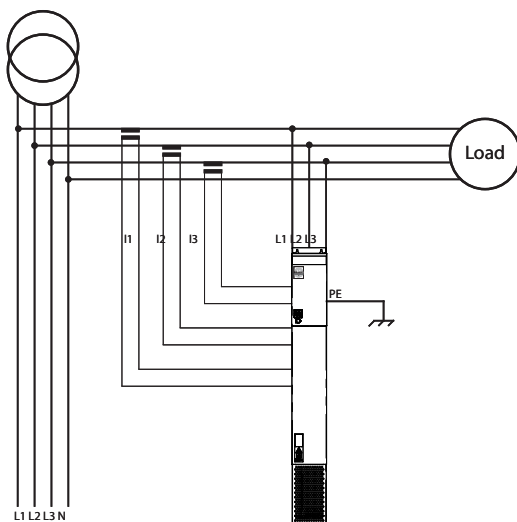

Dimensions

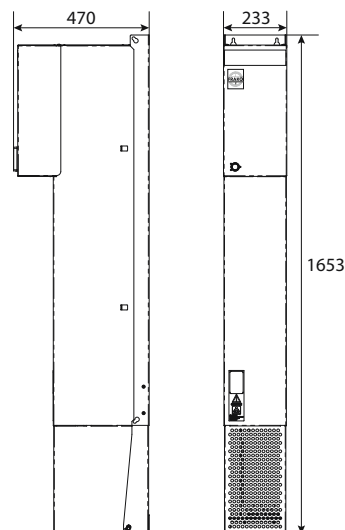

All dimensions in mm

Active Filters

OSFS

Active Filter OSFS-M in freestanding cabinet

Modern medical equipment, the latest LED technology and present-day motor control systems make the most exacting demands on power supply quality. Certain loads, however, greatly distort the supply-side waveform by generating harmonics. This situation often calls for an improvement in power quality. With the FRAKO Modular Active Filter, the distortion caused by individual loads, groups of consumers or the entire electrical installation is reduced to a tolerable level or totally eliminated from the network.

Clear benefits:

- 3 versions enable optimum adaption to the compensation requirement: 120 A, 240 A and 360 A
- Modular construction with only one control unit
- User-friendly touchscreen
- User-friendly remote service
- Current-controlled
- New: optionally also available voltage-controlled
- Voltage range: 208 V – 480 V



Active Filters

OSFS

Technical Data

OSFS-M (3-wire modular unit), 400 V

Type	OSFS 120-400-3-M	OSFS 240-400-3-M	OSFS 360-400-3-M
Article-No.	39-22405	39-22401	39-22406
Power rating	83 kVA	166 kVA	249 kVA
Compensating current per phase at 50/60 Hz	120 A _{rms}	240 A _{rms}	360 A _{rms}
System voltage	400 V ± 10 %		
Nominal frequency	50/60 Hz ± 2 %		
Number of phases	3		
Phase connections	3 phases without neutral conductor (TN, TT, IT)		
Harmonics compensation	Individually up to the 49th harmonic		
Degree of compensation	> 98 %		
Correction of power factor cos φ	Up to 1.0		
Parallel operation	OSFS-M Active Filters can be operated in parallel		
Response time	< 1 ms		
Power loss	< 2725 W	< 5325 W	< 7925 W
Maximum air flow requirements	600 m³/h	1200 m³/h	1800 m³/h
Noise level	< 70 dB (A)		
Ambient conditions	0 up to 95 % relative humidity, non-condensing, max. altitude: 1000 m above sea level		
Operating temperature	0 to 50 °C, up to 40 °C without derating		
Dimensions (W x H x D) [mm]	800 x 2155 x 610		
Weight [kg]	335	472	609
Cabinet colour	Cabinet: RAL 7035 (grey), Base: RAL 7022 (dark grey)		
Type of protection	IP 21 according to IEC 529		
Environmental conditions	Class 3C3 (chemical), class 3S3 (mechanical)		
Electromagnetic compatibility (EMC)	EN 55011, class B	EN 55011, class A	EN 55011, class A
Certificates	CE, ABS		
Interfaces	Web server, Ethernet (Modbus TCP)		

The units can be installed in parallel and are available as standard versions from 208 V to 480 V.

Other voltages and IP-classes on request.

Connection diagram (example)

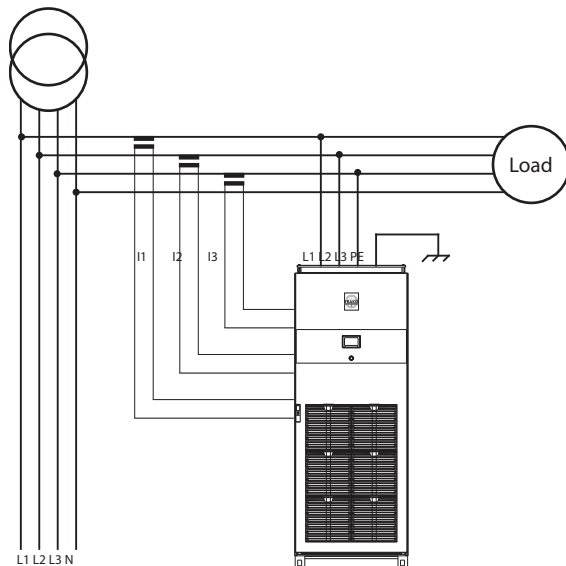

Dimensions

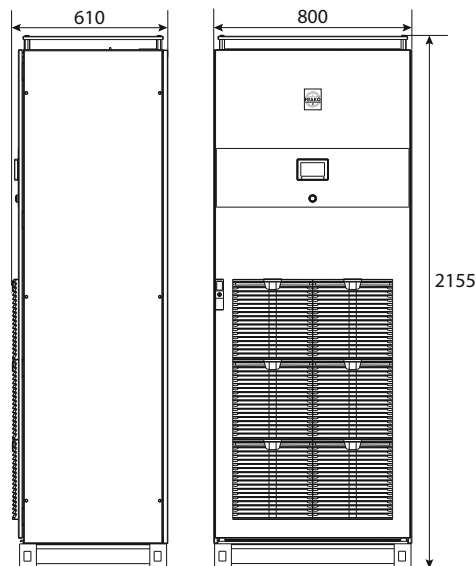

All dimensions in mm

Active Filters

OSFS

Technical Data

OSFS-M (3-wire modular unit), 690 V

Type	OSFS 90-690-3-M	OSFS 180-690-3-M	OSFS 270-690-3-M
Article-No.	39-22410	39-22411	39-22412
Power rating	108 kVA	215 kVA	323 kVA
Compensating current per phase at 50/60 Hz	90 A _{rms}	180 A _{rms}	270 A _{rms}
System voltage	690 V ± 10 %		
Nominal frequency	50/60 Hz ± 2 %		
Number of phases	3		
Phase connections	3 phases without neutral conductor (TN, TT, IT)		
Harmonics compensation	Individually up to the 49th harmonic		
Degree of compensation	> 98 %		
Correction of power factor cos φ	Up to 1.0		
Parallel operation	OSFS-M Active Filters can be operated in parallel		
Response time	< 1 ms		
Power loss	< 2969 W	< 5813 W	< 8657 W
Maximum air flow requirements	600 m³/h	1200 m³/h	1800 m³/h
Noise level	< 70 dB (A)		
Ambient conditions	0 up to 95 % relative humidity, non-condensing, max. altitude: 1000 m above sea level		
Operating temperature	0 to 50 °C, up to 40 °C without derating		
Dimensions (W x H x D) [mm]	800 x 2155 x 610		
Weight [kg]	351	495	639
Cabinet colour	Cabinet: RAL 7035 (grey), Base: RAL 7022 (dark grey)		
Type of protection	IP 21 according to IEC 529		
Environmental conditions	Class 3C3 (chemical), class 3S3 (mechanical)		
Electromagnetic compatibility (EMC)	EN 55011, class B / EN 55011, class A		
Certificates	CE, ABS, DNV GL		
Interfaces	Web server, Ethernet (Modbus TCP)		

The units can be installed in parallel and are available as standard versions from 480 V to 690 V.

Other voltages and IP-classes on request.

Connection diagram (example)

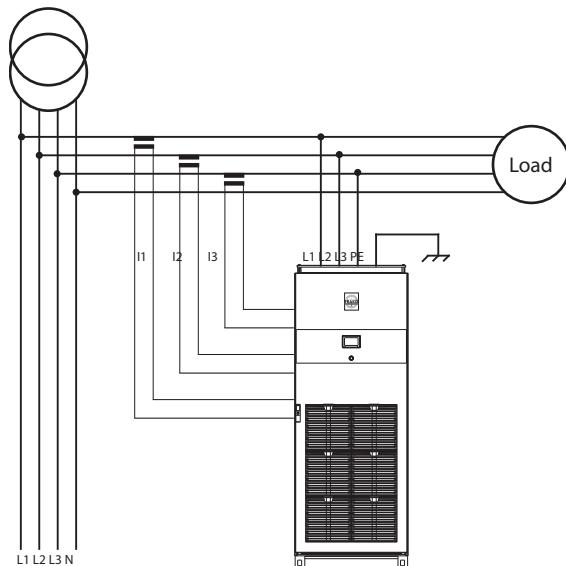

Dimensions

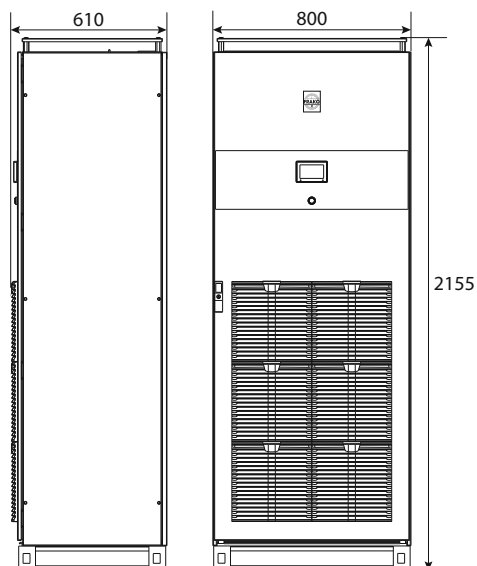

All dimensions in mm

Active Filters

OSFS

Technical Data

OSFS-UL (3-wire modular device, UL), 480 V

Type	OSFS 110-480-3-UL	OSFS 220-480-3-UL	OSFS 330-480-3-UL
Article-No.	39-22423	39-22424	39-22425
Power rating	76 kVA	152 kVA	229 kVA
Compensating current per phase at 50/60 Hz	110 A _{rms}	220 A _{rms}	330 A _{rms}
System voltage	400 V ± 10 %		
Nominal frequency	50/60 Hz ± 2 %		
Number of phases	3		
Phase connections	3 phases without neutral conductor (TN, TT, IT)		
Harmonics compensation	Individually up to the 49th harmonic		
Degree of compensation	> 98 %		
Correction of power factor cos φ	Up to 1.0		
Parallel operation	OSFS-UL Active Filters can be operated in parallel		
Response time	< 1 ms		
Power loss	< 2480 W	< 4835 W	< 7190 W
Maximum air flow requirements	600 m³/h	1200 m³/h	1800 m³/h
Noise level	< 70 dB		
Ambient conditions	0 up to 95 % relative humidity, non-condensing, max. altitude: 1000 m above sea level		
Operating temperature	0 to 50 °C, up to 40 °C without derating		
Dimensions (W x H x D) [mm]	800 x 2155 x 610		
Weight [kg]	335	472	609
Cabinet colour	Cabinet: RAL 7035 (grey), Base: RAL 7022 (dark grey)		
Type of protection	IP 20 according to IEC 529		
Environmental conditions	Class 3C3 (chemical), class 3S3 (mechanical)		
Electromagnetic compatibility (EMC)	EN 61000-6-2, EN 61000-6-4		
Certificates	UL, cUL		
Interfaces	Web server, Ethernet (Modbus TCP)		

The units can be installed in parallel and are available as standard versions from 208 V to 480 V. Other voltages on request.

Connection diagram (example)

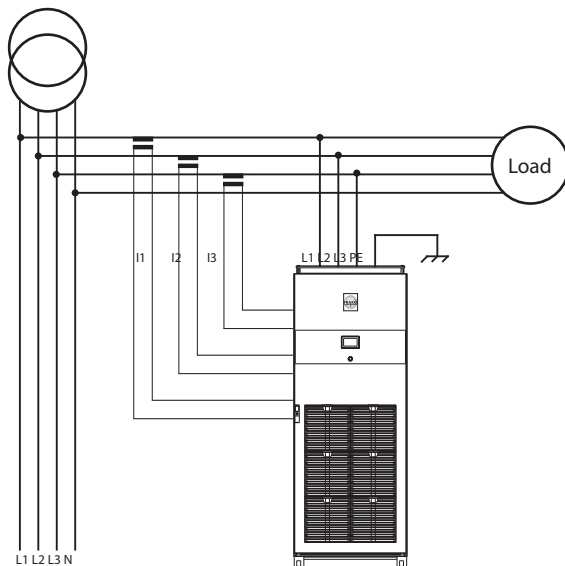

Dimensions

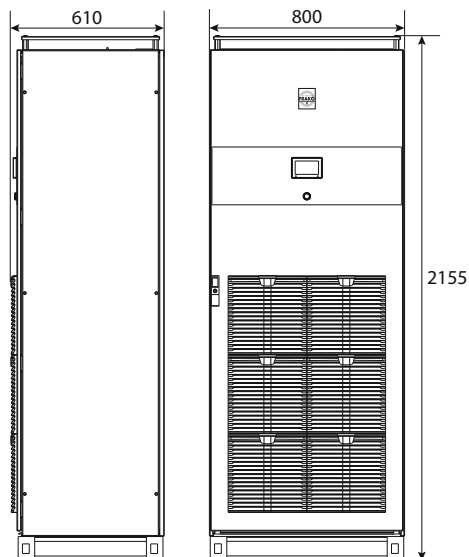

All dimensions in mm

Active Filters

OSFS

Technical Data

OSFS-UL (3-wire modular device, UL), 600 V

Type	OSFS 90-600-3-UL	OSFS 180-600-3-UL	OSFS 270-600-3-UL
Article-No.	39-22426	39-22427	39-22428
Power rating	94 kVA	187 kVA	281 kVA
Compensating current per phase at 50/60 Hz	90 A _{rms}	180 A _{rms}	270 A _{rms}
System voltage	600 V ± 10 %		
Nominal frequency	50/60 Hz ± 2 %		
Number of phases	3		
Phase connections	3 phases without neutral conductor (TN, TT, IT)		
Harmonics compensation	Individually up to the 49th harmonic		
Degree of compensation	> 98 %		
Correction of power factor cos φ	Up to 1.0		
Parallel operation	OSFS-UL Active Filters can be operated in parallel		
Response time	< 1 ms		
Power loss	< 2836 W	< 5547 W	< 8258 W
Maximum air flow requirements	600 m³/h	1200 m³/h	1800 m³/h
Noise level	< 70 dB (A)		
Ambient conditions	0 up to 95 % relative humidity, non-condensing, max. altitude: 1000 m above sea level		
Operating temperature	0 to 50 °C, up to 40 °C without derating		
Dimensions (W x H x D) [mm]	800 x 2155 x 610		
Weight [kg]	351	495	639
Cabinet colour	Cabinet: RAL 7035 (grey), Base: RAL 7022 (dark grey)		
Type of protection	IP 20 according to IEC 529		
Environmental conditions	Class 3C3 (chemical), class 3S3 (mechanical)		
Electromagnetic compatibility (EMC)	EN 61000-6-2, EN 61000-6-4		
Certificates	UL, cUL		
Interfaces	Web server, Ethernet (Modbus TCP)		

The units can be installed in parallel and are available as standard versions from 480 V to 600 V. Other voltages on request.

Connection diagram (example)

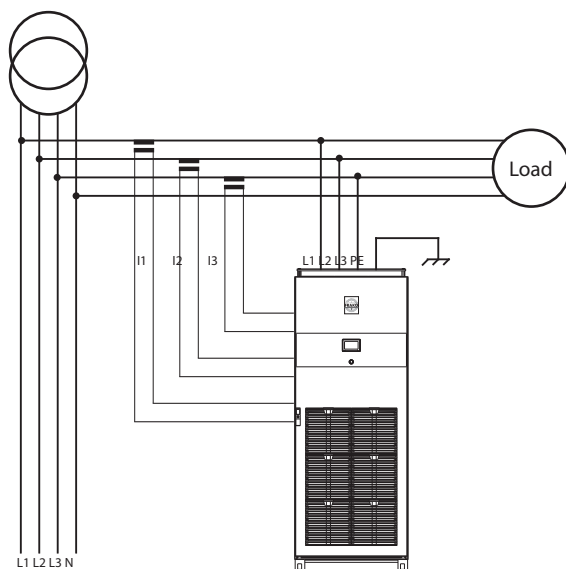

Dimensions

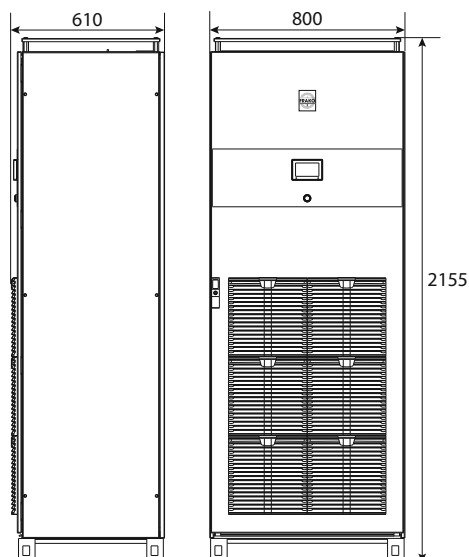

All dimensions in mm

Mains Monitoring

Mains Analysis Devices for DIN rail mounting or door installation

Page 195

Display Units

Page 209

Mains Monitoring / Central Unit

Page 215

Visualization Software

Page 219

Mains Monitoring

Mains Analysis Devices for DIN rail mounting or door installation



Mains Analysis Devices for DIN rail mounting or door installation

The power quality of the electrical supply networks plays an increasingly important role for the operational safety of electrical installations and equipment. Therefore it becomes more and more important to take appropriate measures to monitor the power quality. This thus provides a measurement of the residual current, i.e. the algebraic sum of the currents in L1, L2, L3 and N, as a key parameter in enabling an assessment of the condition of the electrical installation to be made.

In contrast to the past it is obvious that it is not sufficient to do a single measurement and then disregard the mains quality if the measurement showed unproblematic values.

Due to complex production processes, changing load conditions and a steady progress in the degree of automation it became important to permanently monitor the quality of electrical power supply.

Thus one can acquire energy know-how and define critical values for measurement variables such as voltage, current and harmonics.

Automatic alarms via different information channels such as e-mail, SMS, warning lights, etc. allow the control of compliance with the now specified critical values.

Of course, critical values predefined by standards and regulations can also be signalled via these channels.



FRAKO Mains Monitoring devices can handle all these operations.

Depending on type and version this can be achieved already by a single device or – even better - in combination with the FRAKO Energy Management System.

Measurement of residual current, PE-monitoring, monitoring of transformers, measurements at low voltage distribution boards as well as monitoring of individual machines and consumers FRAKO has the solution for every application.

Mains Monitoring

Mains Analysis Devices for DIN rail mounting or door installation

	EM-PQ 2300	EM-PQ 1500 M	EMA 1101
			
Voltage	90-267 V AC or 100-360 V DC	withdrawn from mains voltage	85-267 V AC or 100-377 V DC
Frequency	45-65 Hz	50 Hz	45-65 Hz
Power consumption	Max. 8 W	Max. 7 VA	Max. 7 VA
Contact termination 3/4/5-wire	• / • / •	• / • / -	• / • / -
Current measurements	5 x X/5A	3 x X/5A (error current > 6 mA), galvanically isolated	3 x X/5A (Transformer current > 15 mA), electrically isolated
Voltage measurements	400/600 V AC (L-N/L-L) 3-phases 5-wire system 5 x 80 V AC - 690 V AC (external/external conductor)	3 x 57-230 V AC (external/neutral conductor) 3 x 100-400 V AC (external/external conductor)	3 x 60-400 V AC (external/neutral conductor) 3 x 115-690 V AC (external/external conductor)
Harmonics V/A	1-51	-	1-19
Short term interruptions	•	-	•
Active energy class	1	1	1
Analogue In-/Outputs	- / 2 (0-10 V or 0-20 mA or 4-20 mA)	- / 1 (max. 30 V DC, 100 mA), (4-20 mA DC passive)	2 temperature / -
Digital In-/Outputs	4 / 2	- / 1 (max. 48 V DC, 100 mA); 1 (max. 30 V DC, 100 mA)	Tariff input for selection of 2 profiles / 1 alarm signalling contact 250 V AC, max. 3 A
Memory Min./Max. values	•	•	•
Memory size	256 MB	-	-
Interfaces			
Ethernet	•	-	-
FRAKO Energy Management System	• via FRAKO Starkstrombus Intranet (Ethernet) Modbus/TCP	• via FRAKO Starkstrombus	• via FRAKO Starkstrombus
RS-232 / RS-485	- / •	• / -	- / •
Profibus DP	-	-	-
Webserver / E-Mail / SNMP	• / • / •	- / -	- / -
Recommended applications	Transformer monitoring with residual current measurement and PE-monitoring	Machine disposals	Transformer / NA
Catalogue Page	Page 195 ff.	Page 201 ff.	Page 205 ff.

Mains Monitoring

Mains Analysis Devices for DIN rail mounting or door installation



EM-PQ 2300 Power Quality Analyzer

The power quality of electrical supply networks is of ever increasing importance for the operational reliability of electrical installations and appliances. It is therefore becoming increasingly essential to take appropriate measures to monitor supply network power quality.

The approach used in the past, i.e. simply taking some measurements and then disregarding the power quality issue if these did not appear unusual, is no longer sufficient.

Highly complex manufacturing processes and new power demand profiles, together with ever more sophisticated automation systems, make it today more important than ever to monitor the quality of the power supply on a continuous basis.

This allows the user to accumulate 'energy expertise' and specify sensible alarm settings for parameters such as voltage, current and harmonics.

An automatic alarm function using various means of communication, such as e-mails or alarm annunciators, makes it easier to keep these parameters under control within their specified limits.

The limiting values called for by electrical standards and regulations can, of course, also be monitored in this way.

FRAKO power quality analysis instruments can do all of these things. Depending on instrument type and specifications, these

functions can be performed by a single device alone or in combination with a FRAKO Energy Management System.

Whether the duty is to manage a transformer, take measurements at a low voltage main or secondary distribution board, or monitor individual electrical machines or loads, FRAKO has the right instrument for every application.

Description

Power supply monitoring instrument for the acquisition, monitoring and analysis of electrical data in networks up to 690 V (phase-phase, optional with article No. 20-30243, measurement range extension), with 5 current transformer inputs and 4 voltage inputs, including residual current measurement (the algebraic sum of the currents in L1, L2, L3 and N, being equal to zero in the ideal case) and PE monitoring.

Permanent and simultaneous monitoring of up to 250 measurement points. The instrument offers more than 600 measurement points to be selected from. Its power failure detection function enables a supply failure of up to one second to be buffered, so that those short dips of particular interest can also be recorded by the EM-PQ 2300 even if the instrument's own power supply is disrupted by this event.

Mains Monitoring

Mains Analysis Devices for DIN rail mounting or door installation

Integrated firewall-friendly web interface. The monitoring function enables an entire building, for example, to be continuously checked for the presence of earth fault currents automatically. This means that incipient insulation faults can be detected at a very early stage and reported to the office responsible for electrical safety.

In many companies, manufacturing automation and IT are still two different worlds. The EM-PQ 2300 solves this problem with the Simple Network Management Protocol (SNMP), an integrated communications interface that enables measurement data from the automation area to be automatically transferred to the IT area.

- Long-term network analysis to EN 50160 or EN 61000-2-4
- Monitoring of supply voltage dips
- Harmonics analysis, current and voltage up to 50th harmonics
- Monitoring of earth conductor current and residual current detection
- User-selectable data recording, e.g. analysis of power demand curve profile
- Display of measurement readings and curves at the optional EM-FD 2500 display, connected to the EM-PQ 2300 Power Quality Analyzer by a 4-core cable. One display can indicate the data from up to 7 EM-PQ 2300 instruments.
- Inputs:
 - 5 current transformer inputs for L1 to L3/N/(PE)
 - 4 voltage inputs for L1 to L3/N and Lx/N up to 690 V (extension option)
 - 3 freely assignable S0 pulse inputs for status signals, energy metering and power calculation, or to synchronize metering with the power supplier

- 1 S0 pulse input for tariff switching
- 1 Pt100/1000 4-wire resistance temperature detector input, automatic probe type identification
- Outputs:
 - 1 alarm contact rated at up to 250 V AC
 - 2 digital outputs for alarm purposes. The outputs are electrically isolated and are rated up to 30 V DC
 - 2 analogue outputs for any 2 desired measurement readings, as 0–20 mA, 4–20 mA or 0–10 V signal, internal instrument voltage source, automatic voltage/current identification
- Interfaces:
 - RS-485 bus, for connection to FRAKO Energy Management System
 - Ethernet (RJ45 jack) for connection to FRAKO Energy Management System
 - Modbus (TCP) slave, SNMP agent: the internal alarm system can transmit e-mails via Ethernet
- Software (Device Manager) included for configuration and display of the stored measurement readings via Ethernet
- IoT compatible, REST interface ('machine to machine')

Data acquisition and recording:

- Acquisition and recording of the minimum, maximum and average values of the measurement readings and acquisition intervals defined by the user over parameterized periods of time
- Detection of under- and overvoltages V_{rms}
- Detection of voltage failures V_{rms}
- Detection of inrush currents (10 ms)
- Energy meter (active and reactive power, consumed and fed into network)
- Internal data storage: 256 MB flash memory

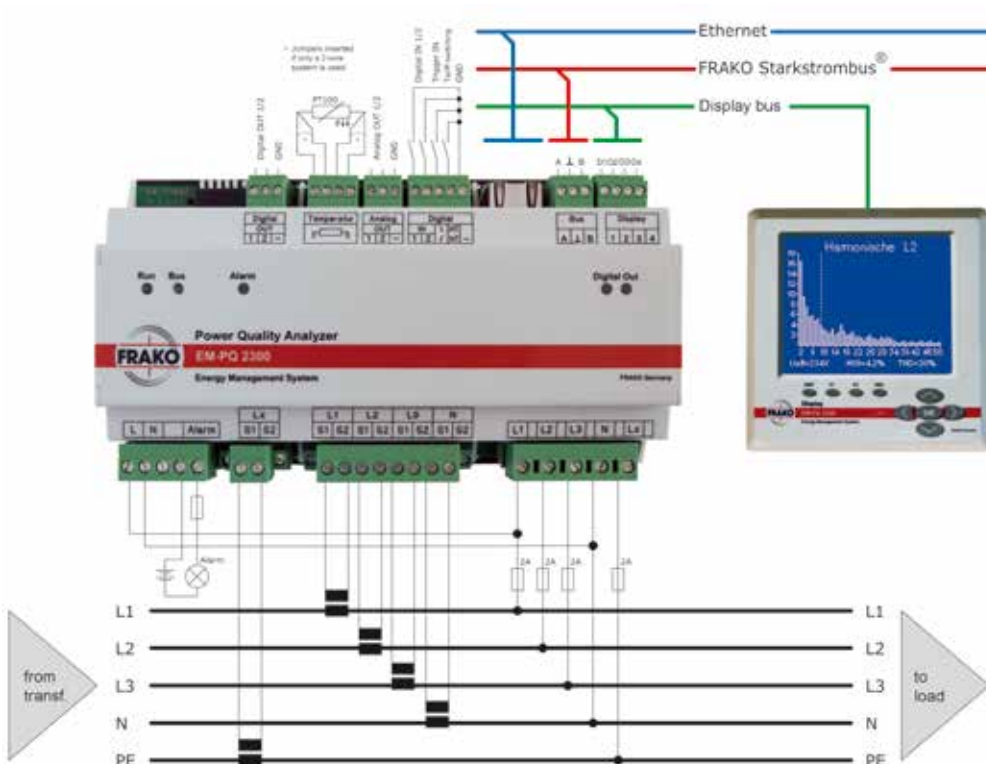

EM-PQ 2300 wiring diagram

Mains Monitoring

Mains Analysis Devices for DIN rail mounting or door installation

Easy installation with the DIN rail-mounted enclosure

The EM-PQ 2300 is housed in an enclosure with a pin strip underneath it.

This system, consisting of pin and socket strips and DIN rail bus connectors, enables the individual modules to be easily fitted and connected to one another.

All connections are also available at external terminals for conventional wiring. Use of the 16-pin DIN rail bus connector provides automatic contact from instrument to instrument.

The bus connector enables the FRAKO Starkstrombus, extension bus and display bus to be connected. The pin and socket strips on the DIN rail ensure quick and easy installation of the instruments in parallel.

It is possible to plug individual instruments in or remove them without dismantling the modular assembly.

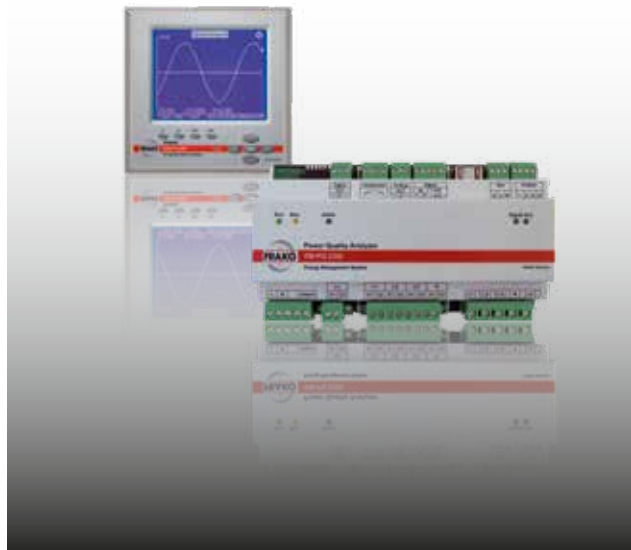

Data display on the EM-FD 2500

The EM-FD 2500 has been developed as a physically separate LCD display and operator panel to work with all FRAKO Energy Management devices of the new generation that require this, such as the EM-PQ 2300 and EM-MC 2200 instruments.

The Display is connected to the EM instrument via 4 terminals: two wires for the instrument power supply and two for data transfer. A maximum of 8 instruments can be connected to a common display bus, with a bus length of up to 40 m to the Display.

The Display is mounted on the control cabinet door or wall through a $\text{Ø} 22.5 \text{ mm}$ hole, thus greatly simplifying installation. Its orientation is fixed by a screw through the wall into a threaded bush.

Alternatively, the Display can also be mounted in any available 144 x 144 mm cut-out.

Mains Monitoring

Mains Analysis Devices for DIN rail mounting or door installation

Web interface to display the momentary measurement readings and the event list

- Web server for the configuration and online display of all measurement readings
- Every user at any PC can view the most important measurement data via the intranet

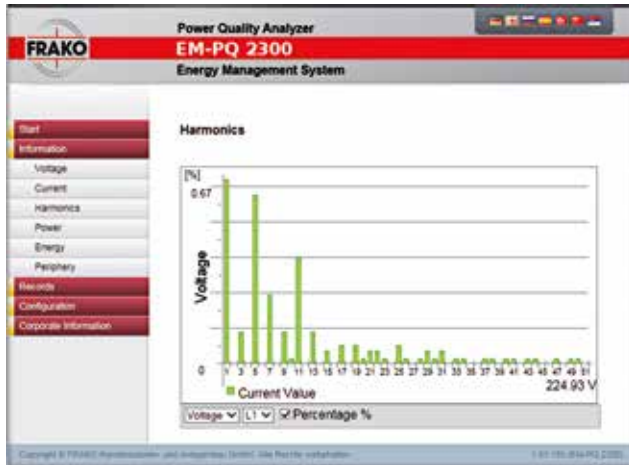

4

Device Manager – Clear overview and straightforward programming

• Momentary measurement readings

All key measurement data from the EM-PQ 2300 are displayed in a clear overview.

With most measurement points, each individual section can be expanded to display the extreme values in the last interval and the extreme values since the last reset.

The V/I bar graph indicator, which ranges from 0 to full scale value, offers a quick check on the extent to which the current and voltage measurement ranges are being used. This shows immediately whether the current transformers are correctly dimensioned.

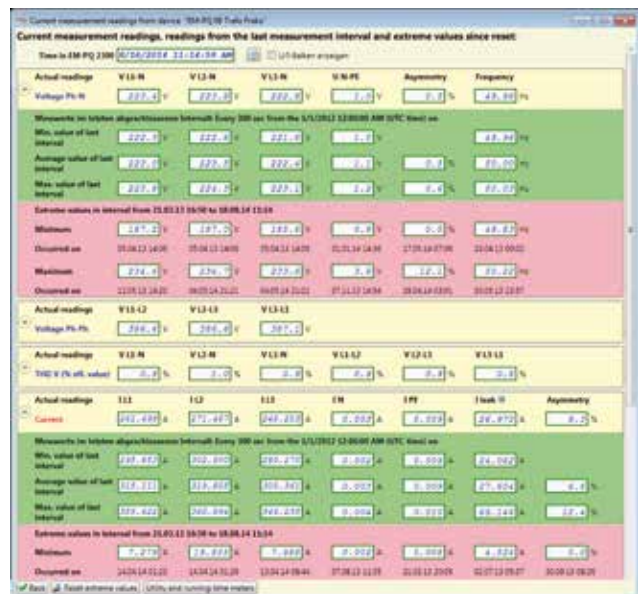

• Continuous data recording

The continuous data recording function of the EM-PQ 2300 can be configured as desired.

Up to 250 data points can be recorded, the time interval and the type of reading (minimum, average or maximum value) being specified for each data point.

In addition, the option of defining charts and assigning data points to them is also given, so that when the EM-PQ 2300 is accessed, regardless of the PC on which the device manager is installed on, the same charts will always be available.

Mains Monitoring

Mains Analysis Devices for DIN rail mounting or door installation

- **Event-driven data recording including the period prior to the triggering event**

Various events can trigger the recording of data for a limited time independently of the continuous recording function. The user is free to define which measurements are recorded and for how long.

This 'pretrigger' function also enables the measurements from the time leading up to the triggering event to be recorded. If this is set at 25 %, and the duration of the recording period at one hour, the EM-PQ 2300 will record the measurements made over the 15 minutes before the triggering event and the 45 minutes after it. The EM-PQ 2300 does this by continuously recording the measurements in a small circular buffer. When the recording period is over, the data from before and after the event are saved in a file, and the message 'Measurement completed' appears as a new entry in the event report.

Clicking the button in the 'Att.' (Attachment) column will display the measurement.

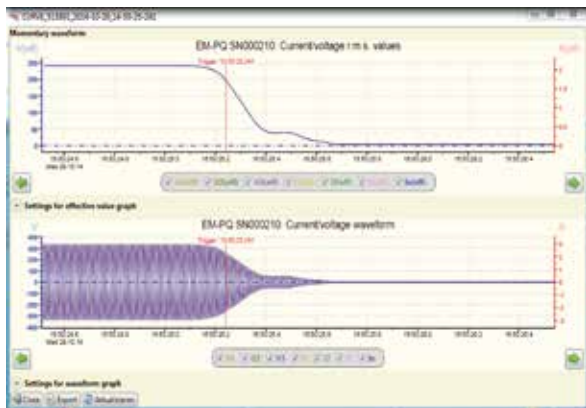
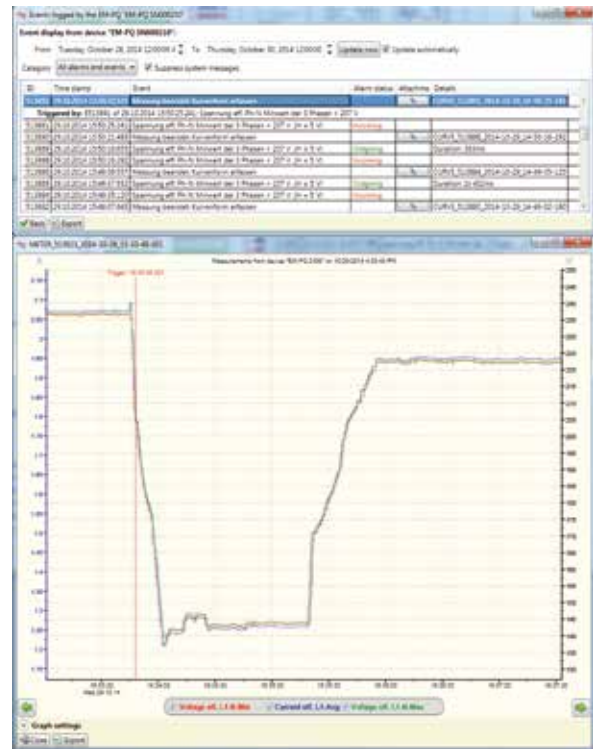

- **Analysis to EN 50160 or IEC 61000-2-4**

The EM-PQ 2300 can be configured so that it carries out an analysis every week, saving this as a results file, which can then be loaded via the event report.

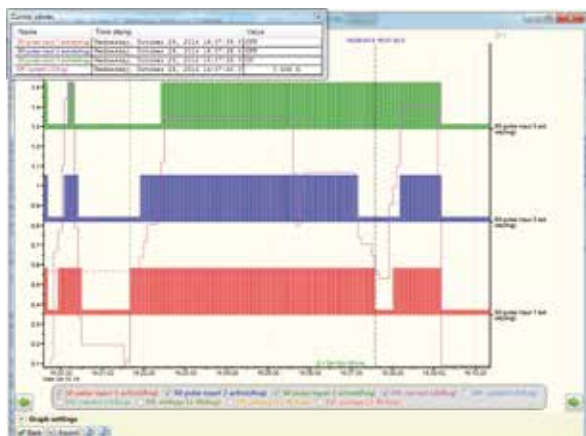

Apart from the user-defined measurements, predefined short-term measurements covering periods of 2 or 6 seconds can also be triggered, the current and voltage measurements being saved both as root-mean-square values over 10 ms intervals and as waveform curves.

An additional feature is that an e-mail can be sent after a measurement is completed. Clicking the e-mail attachment on any PC on which Device Manager or FRAKO-NET is installed will display the measurement.

- **Energy meter for each phase**

The EM-PQ 2300 meters the energy of each phase in addition to the total energy. Two resettable energy meters and one non-resettable meter are available for each phase. Resetting can be performed manually or automatically at any desired interval.

- **User-friendly evaluation in the chart with cursor values and display of min. and max. readings**

By activating the cursor lines, the readings can be displayed in a table and time differences can be measured.

The min./max. display enables the user to find minimum and maximum values over long periods and to display them on an enlarged scale.

The min./max. display can also be used with an energy meter to determine the energy consumption over a set period. This is displayed directly in the 'Max - Min' column.

Mains Monitoring

Mains Analysis Devices for DIN rail mounting or door installation

Technical Data

Power supply	
Voltage	90-267 V AC or 100-360 V DC
Frequency	45...65 Hz
Power consumption	Max. 8 W
Measurement inputs	
Connection w.	•/•/•
Cat. 3/4/5 cable	
Current measurement inputs	5 x X/5A
Voltage measurement inputs	4 x 400/600 V AC (L-N/L-L); 3-phase 5-wire system
Inputs and outputs	
Analogue inputs and outputs	- / 2 (0-10 V or 0-20 mA or 4-20 mA)
Digital inputs and outputs	4/2
Temperature	PT100/1000 4-wire system
Interfaces	
Ethernet	•
FRAKO Energy Management System	FRAKO Starkstrombus Intranet (Ethernet), Modbus (TCP), SNMP (agent)
RS-232 / RS-485	- / •
Profibus DP	-
Web server / e-mail	• / •
	IoT compatible, REST interface (‘machine to machine’)

Display and operation

	Operation via EM-FD 2500 Display / 5 LEDs on EM-PQ 2300
Article-No.	20-30240
Connections	
	Pin and socket strips
Mechanical construction	
Dimensions (W x H x D)	161.6 x 89.7 x 60.5 mm
Ingress protection	Enclosure /terminals: IP 30 / IP 20 according to EN 60529
Protection class	Class 1 according to EN 61140
Enclosure	Flame retardant V0 to UL94
Mounting	On standard 35 mm DIN rail to EN 50022
Weight	Approx. 0.5 kg
Operating conditions	
Ambient temperature	-20 °C...+60 °C
Article-No.	20-30241

Dimensions

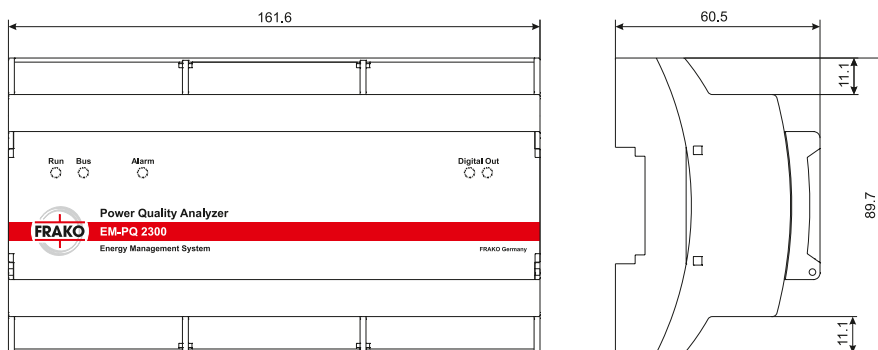

Dimensional drawing EM-PQ 2300

All dimensions in mm

Mains Monitoring

Mains Analysis Devices for DIN rail mounting or door installation



EM-PQ 1500 M Power Quality Analyzer

Power Quality measurement system to detect, analyze and monitor electrical measurement variables in 400 V low voltage mains and medium voltage mains (100 V secondary).

Description

- Monitoring and evaluation of the mains quality; measurement of all relevant mains data in low and medium voltage mains
- Energy meter for active power (input and output) and reactive power
- Different measurements over 10 periods (200 ms, see EN 61000-4-7), measuring range up to the 40th harmonic (distortion factor current/voltage, absolute value of harmonic current)
- 4 voltage and 3 current measurement inputs
- Bimetallic function
- Integrated alarm management with different output configurations: 2x contact outputs, display, LED
- Easily extendable to include up to 15 measurement units via 2 link connections (max. 40 m) for displaying all relevant data via the display EM-FD 1500
- 2 outputs: adjustable digital/analogue (digital, 4-20 mA/ alarm individually programmable)
- Connection to the FRAKO Energy Management System via FRAKO Starkstrombus (RS 485)
- Top hat rail mounting

Mains Monitoring

Mains Analysis Devices for DIN rail mounting or door installation

Technical Data

Measurement inputs	
Voltage path	(Phase-Zero) 3 x 57 - 230 V AC +/- 10 % (Phase-Phase) 3 x 100 - 400 V AC +/- 10 %
Frequency	50 Hz
Power consumption	Max. 7 VA
Fuse protection	Max. 2 A external protection required
Current path	3x X/5A (transformer current >6 mA)
Power consumption	Max. 1.8 VA each transformer connection
Inputs	
Display IN	24 V DC, voltage input for display units with a 24 V control unit
Outputs	
Digital OUT	Max. 48 V DC, max 100 mA DC
Digital/Analogue OUT	Max. 30 V DC, max. 100 mA (DC 4-20 mA passive)
Interfaces	
1 FRAKO Starkstrombus	For connection to FRAKO Energy Management System, according to EN 50170 (P-Net) standardised fieldbus, RS 485 Transfer rate: 76.8 kbit/s Type/ Protocol: RS-485 / P-Net
2 Link Connections	Connection to further EM-PQ 1500 (max. 15) to display on display unit EM-FD 1500 Type/ Protocol: CAN / FRAKO internal
Display	Connection to display unit EM-FD 1500
Mechanical construction	
Dimensions	160 x 102 x 67 mm (W x H x D)
Ingress protection	Housing / terminals IP 40 / IP 20
Version	According to DIN EN 61010-1, DIN EN 61000-6-2 and DIN EN 61000-6-3
Housing	Flame-retardant UL94-V0
Installation	On standard rail 35 mm according to DIN EN 50022
Mounting position	Optional
Weight	Approx. 0.5 kg
Operating conditions	
Ambient temperature	0 °C up to +55 °C
Article-No.	20-30212

Optional Accessories

Article-No.	Type	Description
20-30233	Interface adapter EM-PQ-RS 232	RS-232 Adapter for PC direct access to the data of EM-PQ 1500, including display and configuration software EM-PQ-SW; Cable length: 3 m
20-10700	Mains adapter for Analogue Module EM-AM 24 V DC (can be used as well for EM-PQ 1500)	Switching power supply for DIN rail mounting 24 V DC / 0.35 A and 12 V DC / 20 mA; Mains power supply: 85 to 264 V AC
20-10317	EM-PQ-SW	Software for the configuration and online display of data from the EM-PQ 1500 Power Quality Monitor. Access via: data collector, EMP 1100, EMT 1101 and EM-PQ-RS 232 adapter. Note: included with FRAKO-NET when supplied on CD-ROM

Mains Monitoring

Mains Analysis Devices for DIN rail mounting or door installation

Dimensions

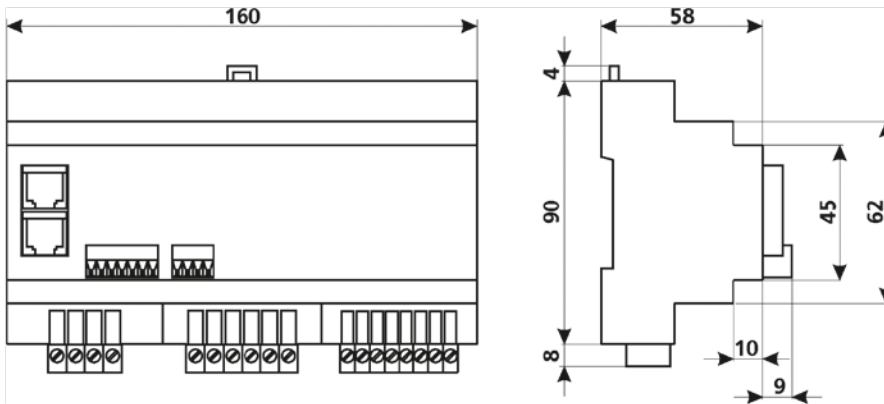

Dimensional drawing EM-PQ 1500 M

All dimensions in mm

Mains Monitoring

Mains Analysis Devices for DIN rail mounting or door installation



Mains Monitoring

Mains Analysis Devices for DIN rail mounting or door installation



PQA 1101 Power Quality Analyzer

A measuring and monitoring instrument for the acquisition, analysis and supervision of all key electrical data in low voltage 3-phase systems from 115 V to 690 V.

Description

Measurement functions:

- Phase-phase and phase-neutral voltages
- Currents in the 3 phases and N / PEN conductors
- $\cos \varphi$, active and apparent power for each phase
- Frequency and asymmetry (load unbalance)
- THD of voltage and current for each phase
- Proportion of voltage/current harmonics V2 – V19 / I2 – I19
- Manual acquisition of voltage and current up to the 50th harmonic

Selectable options:

- 2x active and reactive energy via external tariff switching, or:
 - 1x active and reactive energy (imported)
 - 1x active energy (power feed-in / in-house generation)
 - 2x temperature via external PT100 RTD probes

Measurement data and Min/Max memory:

Measurement data per phase

- Voltage
- Storage
- Power (active, reactive and apparent power)
- Supply frequency
- Overcurrent
- Voltage harmonics
- Current harmonics
- Temperatures PT1 and PT2
- Measurement via three external current transformers
- Menu-driven user interface in plain language with display of up to 8 measurement readings simultaneously
- Menu-driven configuration with user dialogue
- Backlit display
- Meter readings and alarm limits saved on power failure

Mains Monitoring

Mains Analysis Devices for DIN rail mounting or door installation

Technical Data

Power supply	
Mains voltage	85 V AC – 267 V AC (absolute limits), Frequency 45 – 65 Hz or 100 V DC – 377 V DC (absolute limits)
Power consumption	Max. 5 VA
Fuse protection	2 A external protection required
Measurement input	
Voltage path	80 V AC – maximum 760 V AC (phase – phase, absolute limits), suitable for 115 – 690 V AC systems, electrically interconnected via high resistances, measurement of medium voltages possible using an x/100 V transformer; In areas where UL / CSA standards apply in systems with nominal voltages 115 – 600 V AC; power failure detection after duration of a half-wave
Current path	x/5 A AC or x/1 A AC (transformer secondary current > 15 mA), electrically isolated, power draw maximum 1 VA per transformer connection, continuous overload rating up to 6 A AC, transient overload maximum 10 A AC for 10 seconds
Outputs	
1 Alarm signalling contact	Volt-free NO contact, AC-14 250 V AC, maximum 3 A or DC-13 – 30 V DC, maximum 3 A, Note: utilization category AC-/DC- as per IEC 60947-5-1
Inputs	
Tariff inputs	2 profiles selectable (e.g. HT/NT) Control via open collector output. Voltage withstand rating required: 10 V.

Interfaces (mode can be selected)	
FRAKO Starkstrombus	For connection to the FRAKO Energy Management System, standardized fieldbus, RS 485, Protocol P-Net
Operating elements	Membrane keyboard with 5 keys
Display elements	Backlit LC Display with 128 x 64 pixel
Connections	Plug-in connecting strips (included with delivery)
Mechanical construction	
Dimensions	Dimensions of front panel: 144 x 144 mm (DIN 43700), panel cut-out: 138 x 138 mm (DIN 43700), installation depth: 75 mm
Ingress protection	Front of instrument IP40 (with seal set IP54), rear of instrument IP20 all as per 60529, contamination level 2 as per EN 61010-1:2011-07
Version	Housing protection class 1 according to DIN EN 61140
Installation	From front panel with screwdriver
Weight	Approx. 0.77 kg
Operating conditions	
Ambient temperature	0 °C up to +55 °C

Dimensions

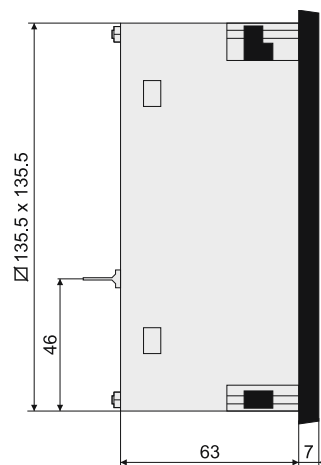
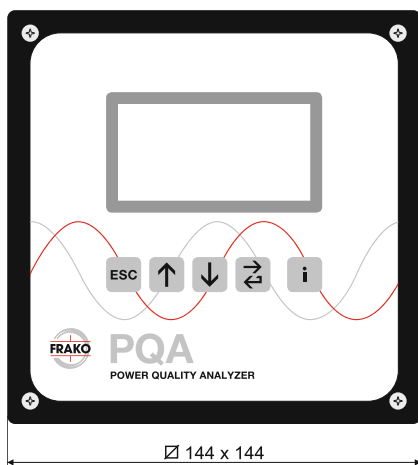

Dimensional Drawing PQA 1101

all dimensions in mm

Mains Monitoring



Display Units



Display Units

The monitoring of currents, harmonics, temperatures, etc. has now become standard practice to uphold supply network quality. The FRAKO Starkstrombus and the other components of the system form a powerful energy information system. All data are available centrally.

4

	EM-FD 2500	EM-FD 1500
		 Discontinued model – only a limited number of items available.
Voltage	supplied via EM device	24 V DC \pm 15 % or 85-264 V AC
Frequency	-	50/60 Hz
Power consumption	Max. 3 VA	Max. 3 VA
Operating-/display element	9 buttons / bright LC display / 1 LED	9 buttons / bright LC display
Interfaces		
CAN-Bus	•	
RS-232 / RS-485	-	-
Connection with	EM-MC 2200 EM-PQ 2300	EM-PQ 1500
Catalogue page	Page 211 ff.	Page 213 ff.

Mains Monitoring

Display Units

4



Mains Monitoring

Display Units



EM-FD 2500 Display Unit

The EM-FD 2500 is a graphic display in DIN rail housing to display measurements and wave forms of up to 7 Energy Management devices of the latest generation (e.g. Maximum Controller EM-MC 2200 or Mains Monitoring Unit EM-PQ 2300).

Description

- Front mounting of the display with little effort by a \varnothing 22.5 mm fixing and a screw to prevent rotation
- Only one cable (4-pin) from the display to the EM device
- Connection of max. 8 EM devices via display bus:
 - 1 display + 7 EM devices
 - 2 displays + 6 EM devices

Mains Monitoring

Display Units

Technical Data

Power supply	
Voltage	11 V up to 16 V DC, reverse polarity protection, power is to be connected by the EM device
Fuse protection	Internal via 500 mA SMD fuse
Power consumption	Max. 3 VA
Connections	Via plug-in terminals
Conductor cross-section	Max. 1.5 mm ²
Interfaces	
Display bus	CAN according to ISO 11898, RS-485, impedance level 120 Ohm Transfer rate: 1 Mbit/s Length of bus: max. 40 m
Mechanical construction	
Dimensions	147 × 147 × 53 mm (W × H × D) including connector, cabinet overhang 23 mm, depth cabinet max. 30 mm, including connector
Ingress protection	Front panel IP54 when using the enclosed sealing mat, housing front IP50 without sealing mat, terminals and terminal area IP20, degree of pollution 3, all data according to DIN EN 60529
Installation	In the front panel / door through a central hole Ø 22.5 mm and a hole for anti-turn locking , Ø 3.5 mm
Version	Insulated housing, Protection class 3 (SELV), working voltage up to max. 16 V
EMV	EMV according to EN 61326 -1, EN 61000-4-2 electrostatic discharge air 8 kV and conductive 4 kV with horizontal and vertical coupling plate, EN 61000-4-3 EMS radiated 80 MHz - 1GHz, horizontal and vertical, level 10 V/ m = irradiation industries Class B, EN 61000-4-4 Burst 1 kV capacitive on cable, EN 55022A EMI 30 MHz - 1 GHz = irradiation residential area Class A
Weight	330 g
Operating conditions	
Temperature range	0 °C up to +60 °C, no dewing
Installation height	Geographical height max. 2000 m
Article-No.	20-30240

Optional Accessories

Article-No.	Type	Description
20-30242	Adapter plate for EM-FD 2500	Adapter for installation of the EM-FD 2500 in a cabinet opening (138 x 138 mm)

Mains Monitoring

Display Units



Discontinued model – only a limited number of items available. We would be very pleased to recommend an alternative.

EM-FD 1500 Display Unit

Display unit EM-FD 1500 for connection to Power Quality Monitor EM-PQ 1500.

Description

- Displays the data of up to 15 Power Quality Monitors EM-PQ 1500
- Only one line (max. 10 m) from the display unit to the measuring unit
- Plain text menu with illuminated display and keys
- Front mounting the display unit with little effort by only 2 x Ø 22.5 mm dia attachments
- Supply of the display via the control module

Technical Data

Connection	
Power supply (control unit)	EM-FD 1500 24 V DC: 24 V DC +/- 5 % EM-FD 1500 230 V AC: 230 V AC +/- 10 %
Control	EM-FD 1500 24 V DC: 7-wire cable, min. 0.30 mm ² each conductor EM-FD 1500 230 V AC: 5-wire cable, min. 0.30 mm ² each conductor
Control distance	Max. 10 m between EM-FD 1500 and EM-PQ 1500
Mechanical construction	
Dimensions	Display unit: 87 x 87 x 21 mm (W x H x D) Control unit: 75 x 58 x 37 mm (W x H x D)
Ingress protection	Display unit IP65 (after mounting)
Mounting	In the front door, max. door thickness 6 mm
Mounting position	Optional
Weight	Approx. 0.3 kg
Operating conditions	
Ambient temperature	0 °C up to +55 °C, avoid condensation

Mains Monitoring

Display Units

Versions

Article-No.	Type	Description
20-30230	EM-FD 1500 24 V DC-package (incl. power supply)	Display unit EM-FD 1500 for connection to Power Quality Monitor EM-PQ 1500; 24 V DC, incl. power supply
20-30231	EM-FD 1500 24 V DC-package (without power supply)	Display unit EM-FD 1500 for connection to Power Quality Monitor EM-PQ 1500; 24 V DC, without power supply
20-30232	EM-FD 1500 230 V AC-package	Display unit EM-FD 1500 for connection to Power Quality Monitor EM-PQ 1500; 230 V AC

	EM-FD 1500 24 V DC + power supply	EM-FD 1500 24 V DC	EM-FD 1500 230 V AC
Display unit EM-FD 1500	•	•	•
Module 24 V DC	•	•	
Module 230 V AC			•
Connecting cable 2.5 m (EM-PQ 1500 with 24 V DC module)	•	•	
Connecting cable 2.5 m (EM-PQ 1500 with 230 V AC module)			•
2 ferrule resistors for EM-PQ 1500	•	•	•
Power supply 24 V DC	•		

4

Mains Monitoring

Mains Monitoring / Central Unit



Including
6 x S0 pulse
inputs

PQM 1588 Power Quality Manager

The functions of the Power Quality Manager are data acquisition and recording for the power quality management system. In addition, it identifies alarms, records them and transmits them. The PQM 1588 is provided with two RS-485 fieldbus interfaces to support Modbus RTU and FRAKO Starkstrombus (P-NET) protocols simultaneously. An RJ-45 connector also makes an Ethernet network connection possible. Integrated data transfer via the OPC UA interface is also a useful function.

Description

The PQM 1588 Power Quality Manager is a versatile all-rounder that even just as a gateway offers a variety of uses. Its integrated RS-485 and RJ45 interfaces and its built-in flexibility enable the PQM 1588 to interpret diverse protocols and access fieldbus instruments through the communications network.

Protocol options for connection to measuring instruments:

- FRAKO Starkstrombus
- Modbus RTU
- Modbus TCP

Using an external coupler:

- M-BUS

If additional system points are acquired, the Power Quality Manager 1588 will automatically activate its data collector function plus some other useful features:

- OPC UA server
- S0 pulse inputs (6x)
- Numerous alarm functions:
 - Alarm limits (lower/upper) for registered metering and analogue channels
 - Alarm function, individually or in groups via various alarm routes: contacts on the PQM 1588, e-mail, alarm report

User benefits:

- EMVIS 3000 visualization software (included with appropriate system points)
- Web interface for basic configuration
- Software updates to expand range of functions
- Simple data exchange via OPC UA
- IoT compatible, REST interface (machine to machine)

A specified number of system points are required for collecting data from the measuring instruments. These devices can be combined at will up to the limiting number for each type of device.

Your easy access to Power Quality Management 4.0

PQM as bus gateway:

- FRAKO Starkstrombus
- Modbus RTU

PQM as universal data acquisition system:

- Reception and collection of measurement readings and other data from connected devices via Modbus, M-Bus, S0 pulses and TCP/IP
- Monitoring of data with individually configurable alarm limits
- Alerting when variables go outside set limits using various media such as alarm relays or e-mail
- Optimum scalability, providing solutions for all, from the smallest applications right up to major businesses

PQM as remote monitoring unit:

- Monitoring
- Generating alarms

PQM as data collector incl. synchronization:

- Data transfer to third-party systems
- Collation of machine and energy data
- Visualization with any desired software

6 x S0 pulse inputs, freely programmable, can be used as/for:

- Meter
- Operating hours (seconds) counter
- Status channel
- Pulse input for time synchronization with utilities
- Collector of impulses from transducers which convert process variables into a frequency, for example, temperature, humidity mg/m² etc.
- Power calculation from meter pulses
- OPC UA Server (integrated in the device)
- To increase processing power – more stable data transfer via bus and Ethernet
- Gateway (ModBus/Ethernet + P-Net/Ethernet) – depending on the features
- Pulse acquisition (S0 pulse inputs) for another PQM 1588
- Complete small system incl. data collection of pulse meters

Interfaces such as OPC UA and REST

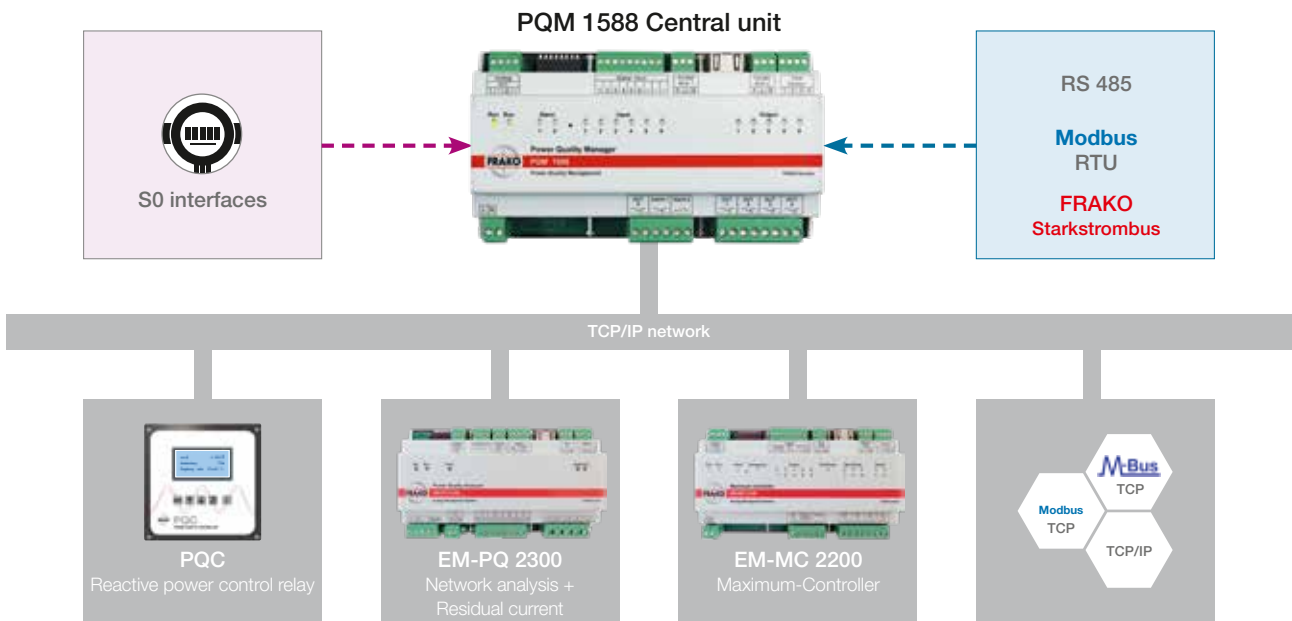

Software for the display/ evaluation of the data:

- including EMVIS 3000 to enable total visualization
- Comprehensive data evaluation
- CSV export facility

New!

Now including
6 x S0 pulse inputs,
freely programmable



Interface for:

- Industry 4.0
- All types of data
- Free choice of database
- Free choice of visualization
- Customized solutions
- Third-party systems

Mains Monitoring

Mains Monitoring / Central Unit

Technical Data

Power Supply	
Supply voltage	100 V AC – 253 V AC (absolute limits), 230 V DC (absolute limits)
Frequency	45 up to 65 Hz
Power consumption	Max. 7 W / 18 VA
Fuse protection	Max. 2 A (slow acting) external protection required
Interfaces	
Ethernet interface	10/100 MBit/s, RJ45 RS-485 Bus 1 Modbus RTU RS-485 Bus 2 FRAKO Starkstrombus
Outputs	
Relay contact	5 contacts – bistable, 250 V / 2 A AC or 30 V / 2 A DC
Alarm contact	1 contact - bistable, 250 V / 2 A AC or 30 V / 2 A DC 1 NC, 250 V / 2 A AC or 30 V / 2 A DC
Inputs	
6 pulse inputs	S0 pulse inputs (DIN 43864) for connecting to volt-free contacts, Open-contact voltage: 15 V, Max. line resistance: 800 Ohm, Short-circuit current: 18 mA, Pulse frequency: 0.1 to 20 Hz
Connections	
via plug-in type screw terminals	Conductor cross-section max. 1.5 mm ² , min. 0.14 mm ² , Relay-, alarm contacts and supply: Conductor cross-section max. 2.5 mm ² , min. 0.2 mm ² , Rated value insulation: 250 V AC, 80 °C
Control elements	
DIP switch	8 pieces
Display elements	
LED	15 pieces
Mechanical Construction	
Dimensions	296 mm × 260 mm × 133 mm (W x H x D)
Installation	On standard rail 35 mm according to DIN EN 50022
Weight	approx. 0.4 kg without packaging
Ingress protection	Enclosure IP30, terminals IP10 according to DIN EN 60529 pollution degree 2 according to EN 61010-1:2011-07
Version	Enclosure protection class II according to DIN EN 61010
Housing	Flammability according to UL 94 V0 as declared by the manufacturer

Mechanical Construction

EMV	EN 55022 Class B : 2010 + AC : 2011 EN 61000-3-2 : 2014 EN 61000-3-3 : 2013 EN 61000-6-3 : 2007 + A1 : 2011 EN 61000-6-2 : 2005 EN 61000-4-2 : 2009 EN 61000-4-3 : 2006 + A1 : 2008 + A2 : 2010 EN 61000-4-4 : 2012 EN 61000-4-5 : 2014 EN 61000-4-6 : 2014 EN 61000-4-8 : 2010 EN 61000-4-11 : 2004
-----	---

Operating conditions

Temperature range	0 °C...45 °C
Installation height	Geographical height max. 2000 m above sea level
Article-No.	20-10090 without system points

PC requirements for FRAKO-NET software package

Hardware	<ul style="list-style-type: none"> • Min. Intel Core I5 • Main memory min. 4 GB RAM • 10 GB free hard drive space • Ethernet 10/100 Mbit/s network connection or/and one free serial interface • DVD drive • SVGA graphics adapter • Colour screen with minimum resolution of 1024 x 768
Software	<ul style="list-style-type: none"> • Microsoft® Windows®* 10 • Microsoft® Windows®* 7 (x32/x64) • Microsoft® Windows®* Server 2008 R2 • current browser for example, Mozilla Firefox <p>* Registered trademarks of Microsoft Corporation</p>

Optional accessories

Article-No.	Type	Description
20-10495	System points upgrading package	10 system points incl. system visualization EMVIS 3000
20-10496	PQM 1588	50 system points
20-10497		100 system points

Mains Monitoring

Mains Monitoring / Central Unit

System points per integrated device	Upper limits
30 System points per EM-MC 2200	Max. 4 units EM-MC 2200 per PQM 1588
15 System points per EM-PQ 2300	Max. 32 units EM-PQ 2300 per PQM 1588 in Slavemode, or max. 8 in Mastermode
15 System points per PQA 1101	Max. 32 units PQA 1101 per PQM 1588
7 System points per PQC (single phase)	
10 System points per PQC (three phase)	
7 System points per EM-PQ 1500	Max. 32 units EM-PQ 1500 per PQM 1588
1 System point per channel of EM-MC 2200, PQA 1101, EM-PQ, EMF 1102 or PQM 1588	Max. 550 metering-, analogue-, status- or alarm channels per PQM 1588
10 System points to activate the S0 function of the PQM 1588	

Web interface Start screen



Web interface Main Configuration – IP address



Dimensions

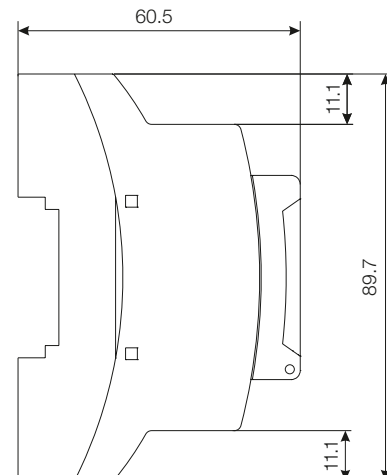
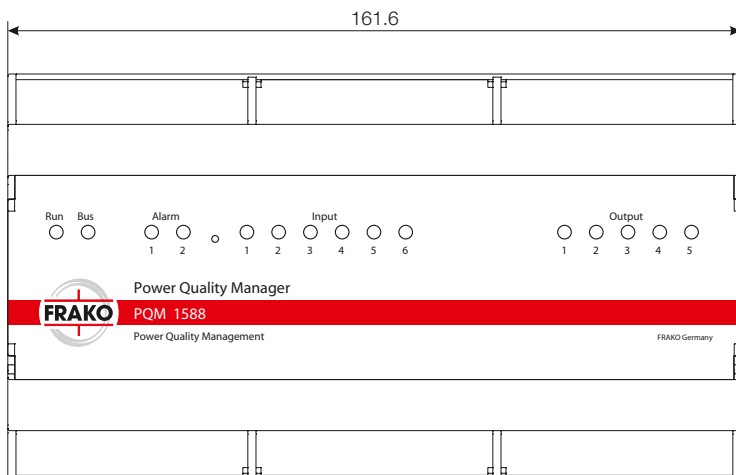

Dimensional drawing PQM 1588

All dimensions in mm

System visualization is INCLUDED if a PQM 1588 with system points is purchased!



suitable for evaluations according to EN 50001

EMVIS 3000 System-Visualization

In the Energy Management System, the measured variables, statuses and events in the entire in-house energy supply system are acquired, processed centrally and saved. They are presented graphically by the visualization facility and evaluated. The EMVIS 3000 software is a powerful tool for displaying and documenting all the measurement readings from the devices connected to the system. A client management function is available, which enables individual organizational system trees to be assigned to different users, who therefore receive exactly those data that they require for their separate purposes. There are two types of installation: either the single workstation or the server version, the latter with access to up to 5 clients simultaneously via a web browser, with no additional installation necessary in the client systems.

EMVIS 3000 comprises the following functional modules:

EMVIS 3000 Project

The project planning tool ...

- Unrestricted configuration and compilation of evaluations of all data processed by the system
- New functions such as alarm visualization, status, history, ranking
- Server version with access via browser
- User administration, the administrator defines user rights and accesses
- Calculation of **performance figures**
Performance figures are virtual data points calculated from other data points, an arithmetic computation from measured or imported data, e.g.: "Active energy A x factor + Water quantity B x factor + Compressed air volume C x factor / No. of items D"
- Creation of **benchmarking** charts
Benchmarking makes a direct comparison of measurement data or performance figures possible, e.g. energy costs of products or company sites
- Creation of **Sankey** diagrams
A Sankey diagram gives a clear overview of any type of flow, e.g. the flow of utilities. The width of each stream into and out

of a location is proportional to the quantity flowing, absolute and percentage values also being stated

- Easy Customizing - individual planning of views - simple and intuitive (the basic package includes 3 views with up to 20 online data points in total)

EMVIS 3000 Report

The reporting tool ...

- To simplify navigation, a clear overview of the entire system is displayed in two system trees, either of which can be selected:
 - **Physical:** standard evaluations of all the instruments and channels registered with the system
 - **Organizational:** all evaluations that have been compiled with EMVIS 3000 Project
- Presentation of historical data for analysis and comparison purposes, e.g. different locations or different periods of time
- For example diagrams showing the time course or diagrams without timeline such as **carpetplot, scatter diagram and heatmap**
- The historical data can be exported directly from the chart or consumption table for further processing. Possible export formats are CSV, Excel, Word and PDF
- Direct access to the momentary readings of the connected instruments

Software

Visualization Software

- Visualization of the alarms occurred is possible through display of the status, history and statistical evaluation in the ranking

EMVIS 3000 Live

- Views created individually - from site layout drawings right down to the distribution board
 - Display of the momentary measurement readings and statuses
- The EMVIS 3000 license enables the software to be installed on several PCs (server and clients). It allows access to the Power Quality Manager PQM 1588 and the Central Unit EMIS1500.

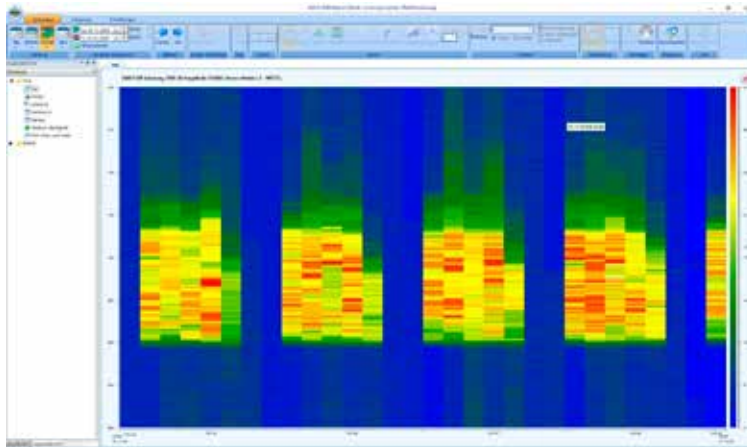

Carpetplot

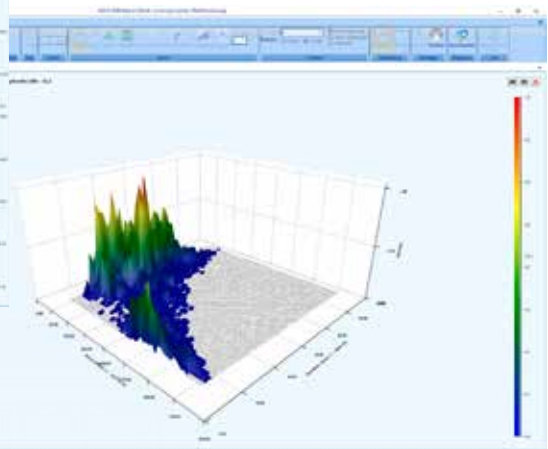

Heatmap 3-D

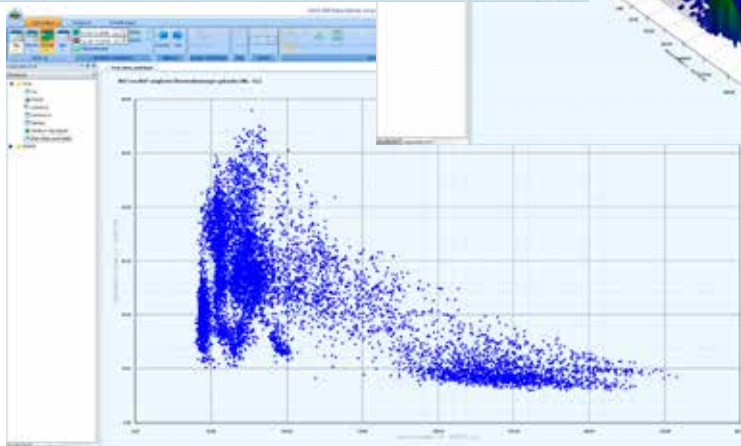

Scatter diagram 2-D



In the physical system tree prepared standard evaluations are deposited for all Energy Management devices. This allows the user to visualize the recorded historical data.

Software

Visualization Software

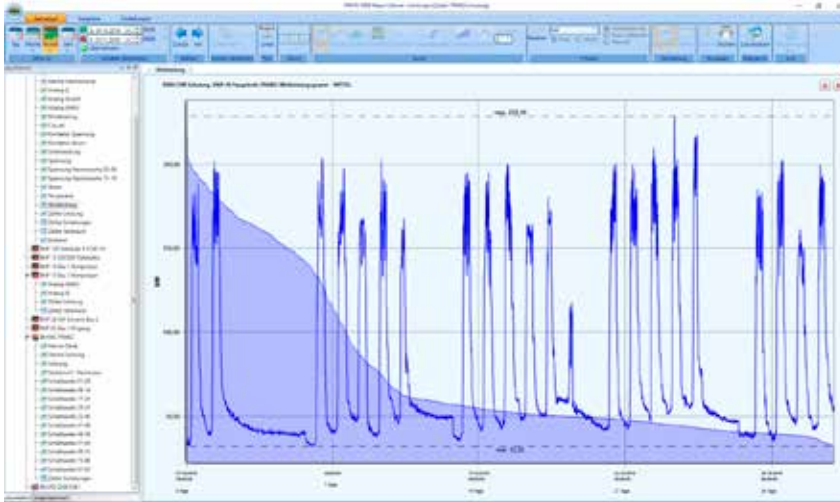

Continuous line graphic - shows the frequency of the variables within a period of time

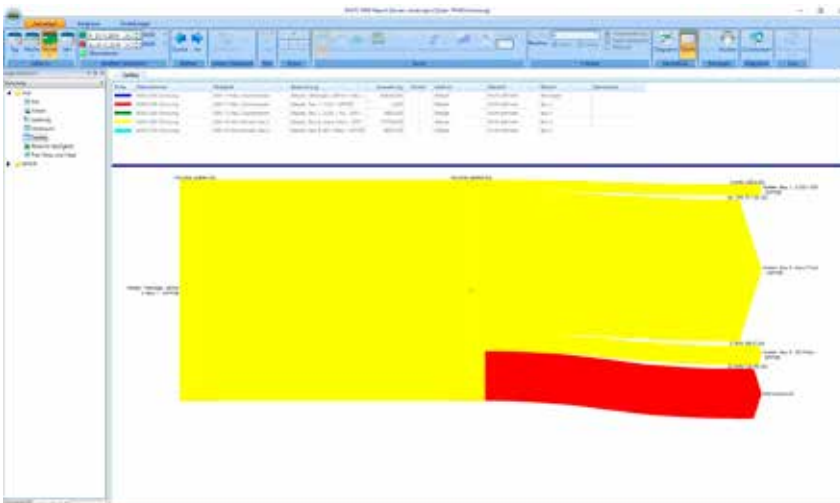

Sankey graphic - shows the flow of energy

The screenshot shows a software window with a toolbar and a sidebar on the left. The main area contains a table with user administration authorization data. The table is titled 'EMVS 3000 Projekt'.

Berechtigung	FRANK/Schulung	SCHULUNGSRV/User1	SCHULUNGSRV/User2
Freigelesen	<input checked="" type="checkbox"/>	<input checked="" type="checkbox"/>	<input checked="" type="checkbox"/>
Phys. SB	<input checked="" type="checkbox"/>	<input checked="" type="checkbox"/>	<input checked="" type="checkbox"/>
OrgSystembaum	<input checked="" type="checkbox"/>	<input checked="" type="checkbox"/>	<input checked="" type="checkbox"/>
Schulung	<input checked="" type="checkbox"/>	<input checked="" type="checkbox"/>	<input checked="" type="checkbox"/>

Authorization graphic - table showing user administration authorization



Standard evaluations for each energy management device are stored in the physical system tree, enabling the user to visualize the recorded and momentary measurement data without the need for individual configuration.

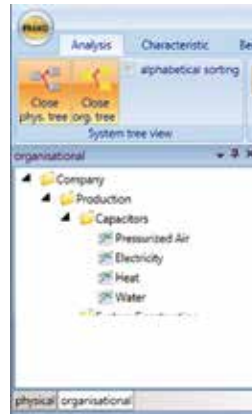

Within the organizational system tree business specific structures are deposited. The business specific structures are projected in form of individual evaluation in the organizational system tree by the customer.

Technical Data

PC requirements for small and medium systems	
Hardware	<ul style="list-style-type: none"> • Min. Intel Core I3-Processor • User memory: 4 GB RAM • 1 GB free hard disk space • Graphics adapter: min. DirectX 9.0c support and 512 MB video memory
Software	<ul style="list-style-type: none"> • Microsoft® Windows® 7 • Microsoft® Windows® 8 • Microsoft® Windows® 10 • Microsoft® Windows® Server 2008 R2 • Microsoft® Windows® Server 2012 R2 • Microsoft® Windows® Server 2016 • Microsoft® .NET Framework 3.5 • Microsoft® .NET Framework 4.5 • FRAKO-NET (min. V1.40.0056 or higher) • Firebird V2.5.0 (included in FRAKO-NET) <p>* Registered trademark of Microsoft Corporation</p> <p>Please note: the server variant will only work with a 64-bit system</p>
Article-No.	20-10649

EMVIS 3000 Extension packages

Article-No.	Type	Description
20-10650	EasyCustomizing-S	Individually designed views with up to 100 data points
20-10651	EasyCustomizing-M	Individually designed views with up to 200 data points
20-10652	EasyCustomizing-L	Individually designed views with up to 350 data points
20-10653	EasyCustomizing-XL	Individually designed views with up to 550 data points
20-10654	EasyCustomizing-XXL	Individually designed views with up to 1000 data points

EMVIS 3000 Software-Update

Article-No.	Type	Description
20-10555	EMVIS 3000 Software-Update	from version 3.0 to the latest version up to V3.XXX

Software

Visualization Software

For example:
application in a work shop

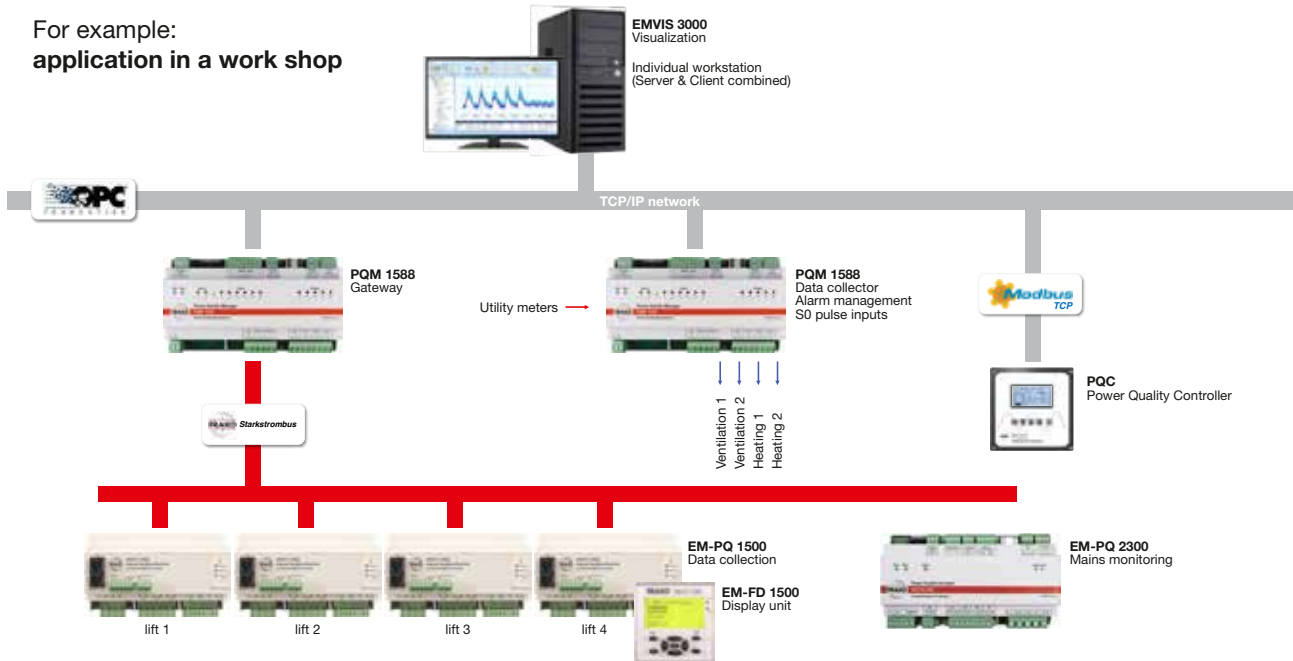

For example:
application in production & office

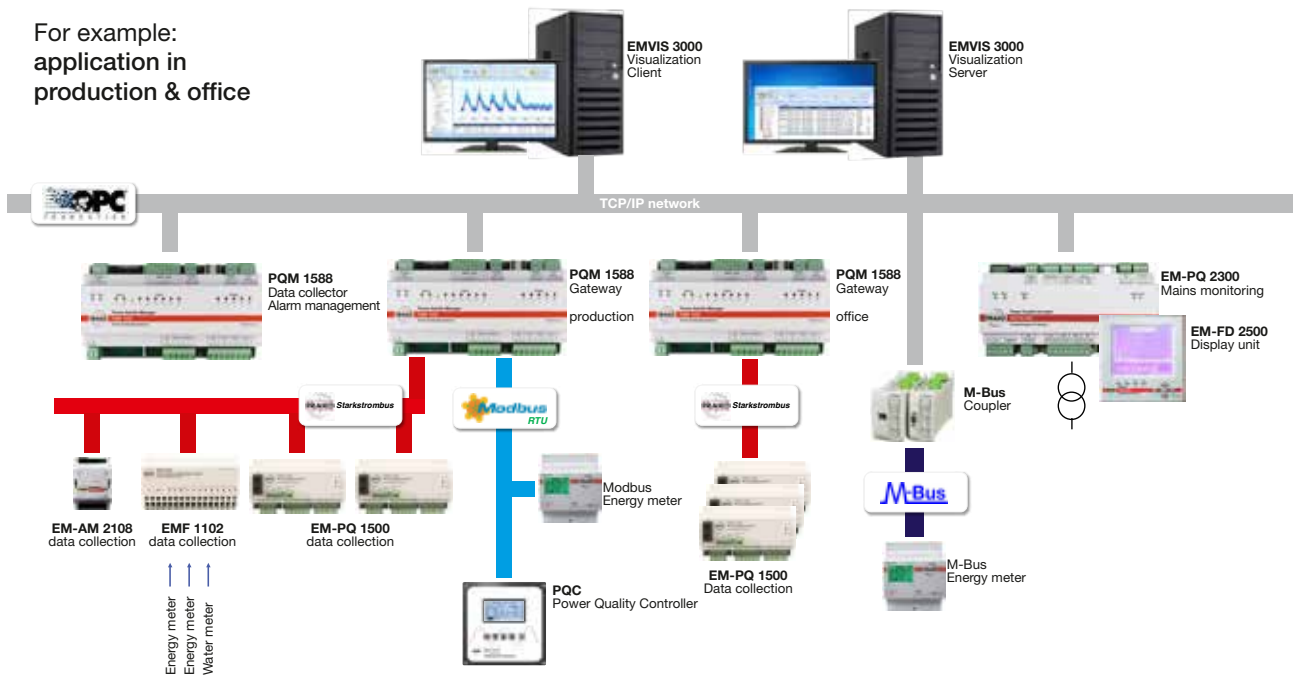

Software

Visualization Software

For example:
application in a work shop

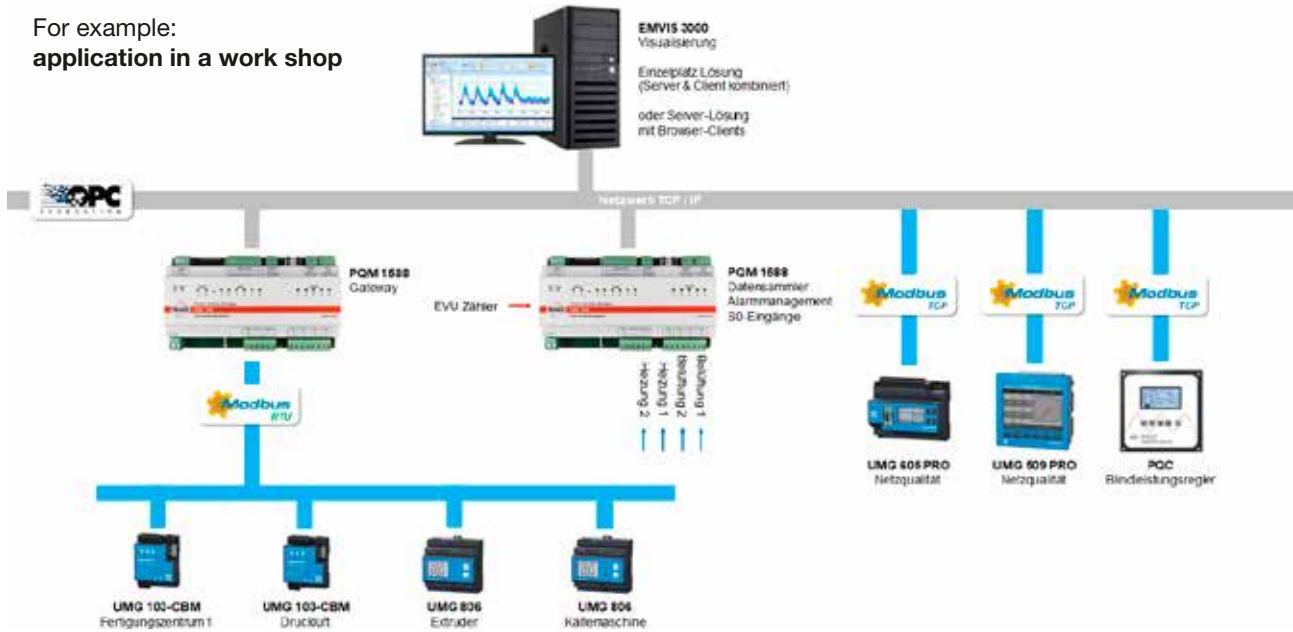

For example:
application in
production & office

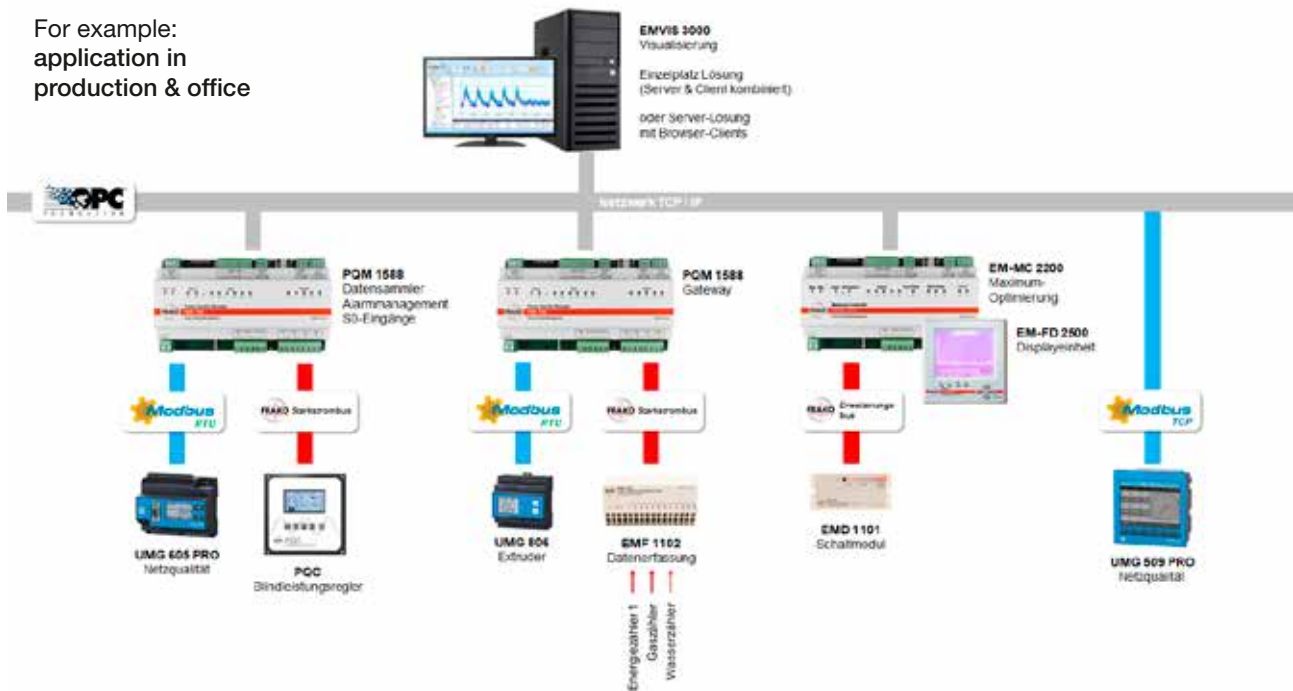

Software

Visualization Software



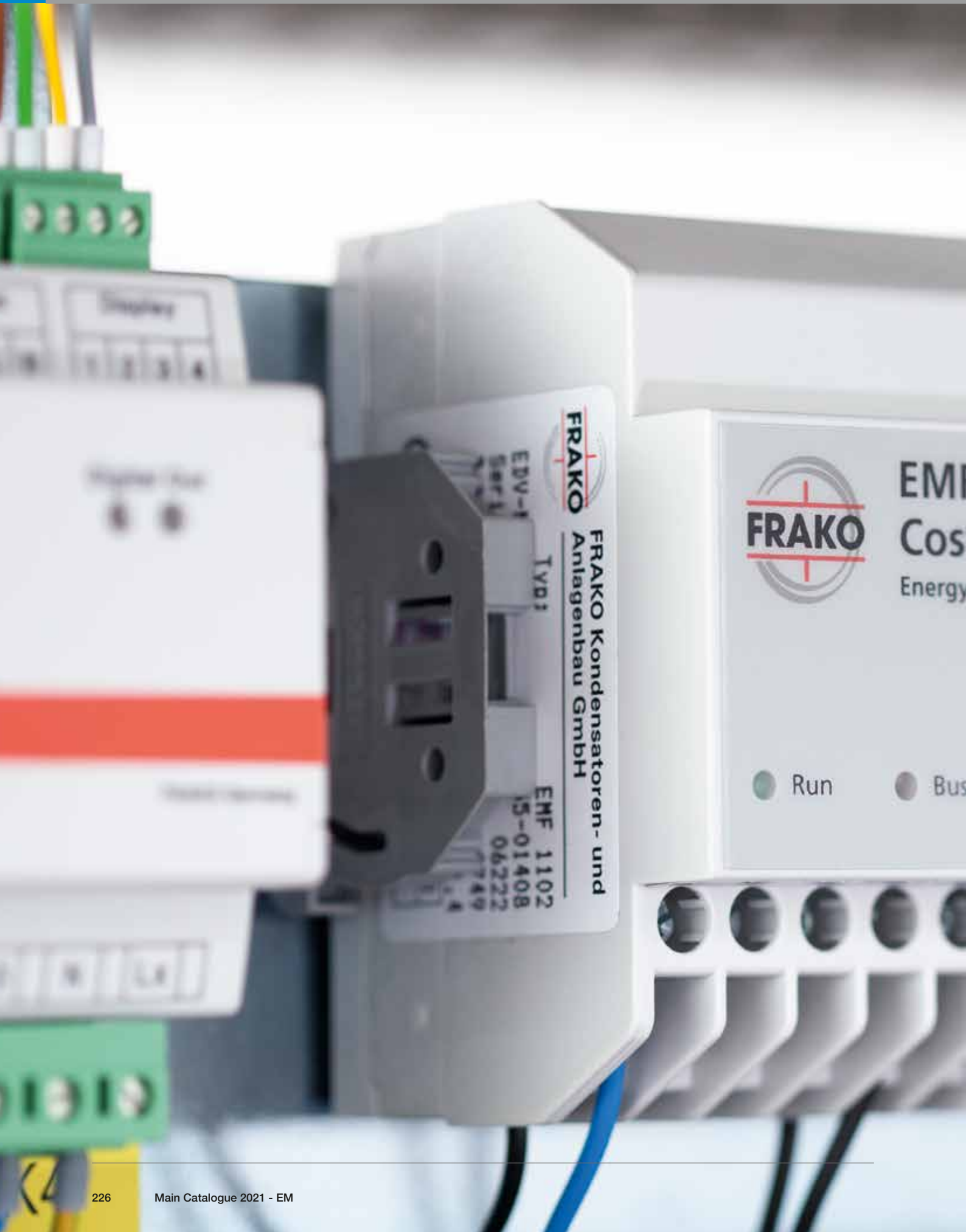

FRAKO

FRAKO Kondensatoren- und
Anlagenbau GmbH

EDV-1

Typ 1

EMF 1102
15-01408
062222



EM
Cos
Energy

● Run

● Bus

System Components

Page 230



1

Maximum Demand Control

Page 240



2

Cost Allocation / Cost Centre Acquisition

Page 250



3

Software

Page 266



4

ENERGY MANAGEMENT



ENERGY MANAGEMENT

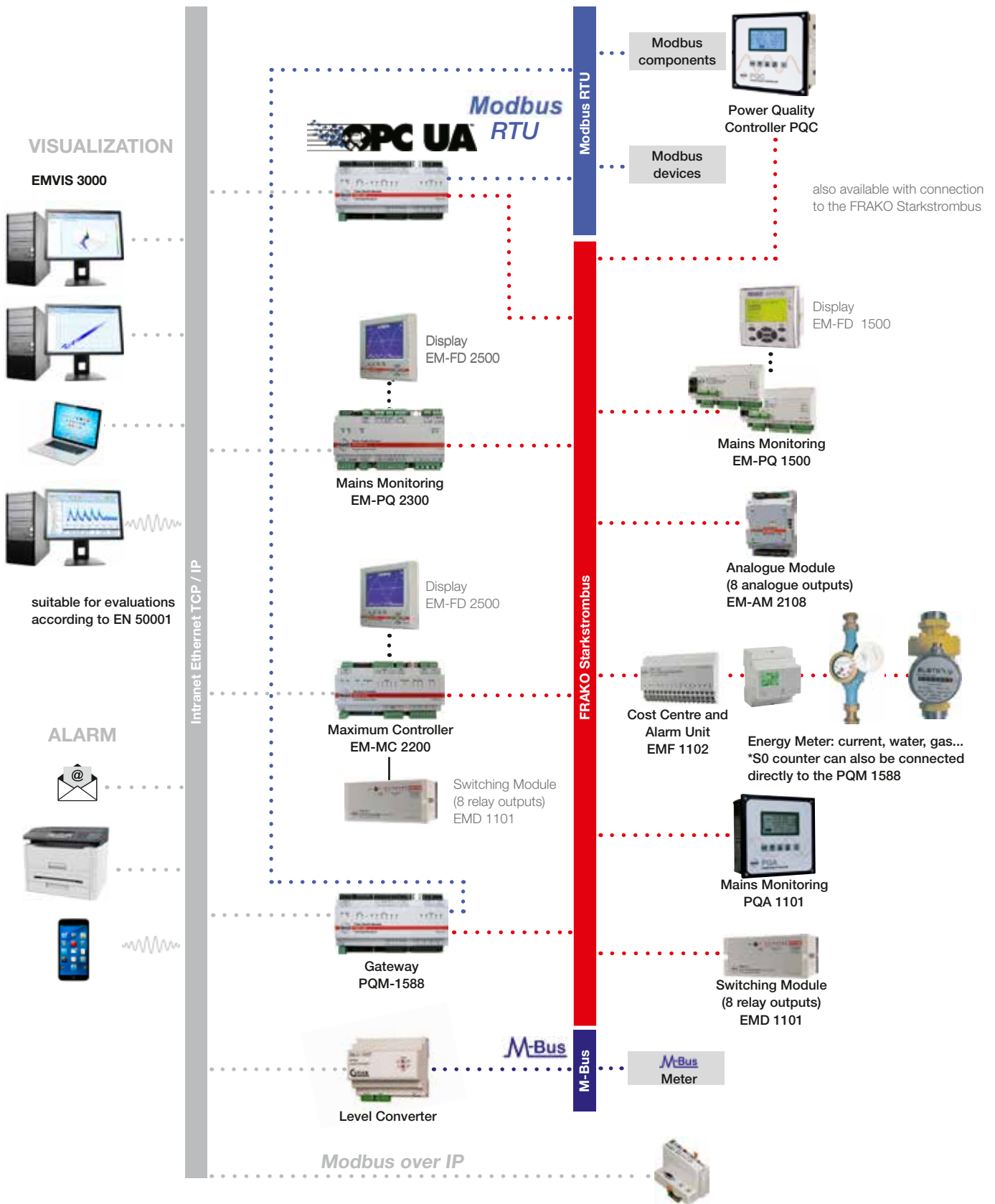

1 System Components

Central Unit

Page 231

Repeater

Page 237

System Components

Central Unit



Including
6 x S0 pulse
inputs

PQM 1588 Power Quality Manager

The functions of the Power Quality Manager are data acquisition and recording for the power quality management system. In addition, it identifies alarms, records them and transmits them. The PQM 1588 is provided with two RS-485 fieldbus interfaces to support Modbus RTU and FRAKO Starkstrombus (P-NET) protocols simultaneously. An RJ-45 connector also makes an Ethernet network connection possible. The PQM 1588 can completely replace an EMIS 1500 Central Unit. Integrated data transfer via the OPC UA interface is also a useful function.

Description

The PQM 1588 Power Quality Manager is a versatile all-rounder that even just as a gateway offers a variety of uses. Its integrated RS-485 and RJ45 interfaces and its built-in flexibility enable the PQM 1588 to interpret diverse protocols and access fieldbus instruments through the communications network.

Protocol options for connection to measuring instruments:

- FRAKO Starkstrombus
- Modbus RTU
- Modbus TCP

Using an external coupler:

- M-BUS

If additional system points are acquired, the Power Quality Manager 1588 will automatically activate its data collector function plus some other useful features:

- OPC UA server
- S0 pulse inputs (6x)
- Numerous alarm functions:
 - Alarm limits (lower/upper) for registered metering and analogue channels
 - Alarm function, individually or in groups via various alarm routes: contacts on the PQM 1588, e-mail, alarm report

User benefits:

- EMVIS 3000 visualization software (included with appropriate system points)
- Web interface for basic configuration
- Software updates to expand range of functions
- Simple data exchange via OPC UA
- IoT compatible, REST interface (machine to machine)

A specified number of system points are required for collecting data from the measuring instruments. These devices can be combined at will up to the limiting number for each type of device.

Your easy access to Power Quality Management 4.0

PQM as bus gateway:

- FRAKO Starkstrombus
- Modbus RTU

PQM as universal data acquisition system:

- Reception and collection of measurement readings and other data from connected devices via Modbus, M-Bus, S0 pulses and TCP/IP
- Monitoring of data with individually configurable alarm limits
- Alerting when variables go outside set limits using various media such as alarm relays or e-mail
- Optimum scalability, providing solutions for all, from the smallest applications right up to major businesses

PQM as remote monitoring unit:

- Monitoring
- Generating alarms

PQM as data collector incl. synchronization:

- Data transfer to third-party systems
- Collation of machine and energy data
- Visualization with any desired software

6 x S0 pulse inputs, freely programmable, can be used as/for:

- Meter
- Operating hours (seconds) counter
- Status channel
- Pulse input for time synchronization with utilities
- Collector of impulses from transducers which convert process variables into a frequency, for example, temperature, humidity mg/m² etc.
- Power calculation from meter pulses
- OPC UA Server (integrated in the device)
- To increase processing power – more stable data transfer via bus and Ethernet
- Gateway (ModBus/Ethernet + P-Net/Ethernet) – depending on the features
- Pulse acquisition (S0 pulse inputs) for another PQM 1588
- Complete small system incl. data collection of pulse meters

Interfaces such as OPC UA and REST

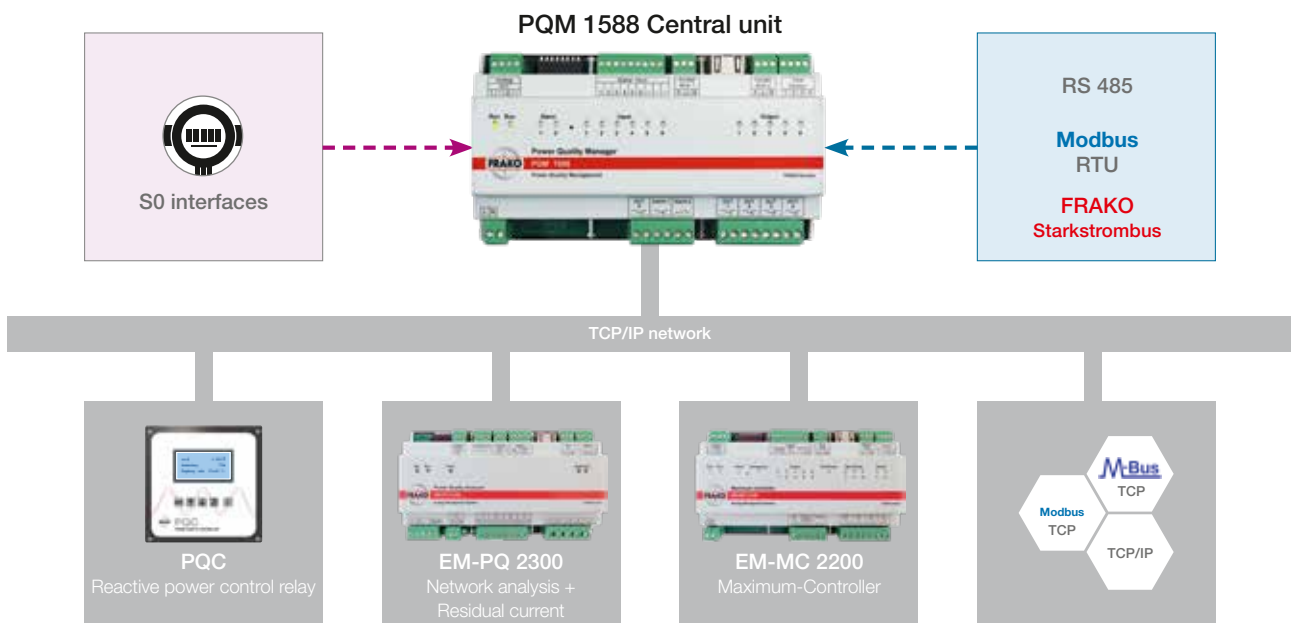

Software for the display/ evaluation of the data:

- including EMVIS 3000 to enable total visualization
- Comprehensive data evaluation
- CSV export facility

New!

Now including
6 x S0 pulse inputs,
freely programmable



Interface for:

- Industry 4.0
- All types of data
- Free choice of database
- Free choice of visualization
- Customized solutions
- Third-party systems

System Components

Central Unit

Technical Data

Power Supply	
Supply voltage	100 V AC – 253 V AC (absolute limits), 230 V DC (absolute limits)
Frequency	45 up to 65 Hz
Power consumption	Max. 7 W / 18 VA
Fuse protection	Max. 2 A (slow acting) external protection required
Interfaces	
Ethernet interface	10/100 MBit/s, RJ45 RS-485 Bus 1 Modbus RTU RS-485 Bus 2 FRAKO Starkstrombus
Outputs	
Relay contact	5 contacts – bistable, 250 V / 2 A AC or 30 V / 2 A DC
Alarm contact	1 contact - bistable, 250 V / 2 A AC or 30 V / 2 A DC 1 NC, 250 V / 2 A AC or 30 V / 2 A DC
Inputs	
6 pulse inputs	S0 pulse inputs (DIN 43864) for connecting to volt-free contacts, Open-contact voltage: 15 V, Max. line resistance: 800 Ohm, Short-circuit current: 18 mA, Pulse frequency: 0.1 to 20 Hz
Connections	
via plug-in type screw terminals	Conductor cross-section max. 1.5 mm ² , min. 0.14 mm ² , Relay-, alarm contacts and supply: Conductor cross-section max. 2.5 mm ² , min. 0.2 mm ² , Rated value insulation: 250 V AC, 80 °C
Control elements	
DIP switch	8 pieces
Display elements	
LED	15 pieces
Mechanical Construction	
Dimensions	296 mm × 260 mm × 133 mm (W x H x D)
Installation	On standard rail 35 mm according to DIN EN 50022
Weight	approx. 0.4 kg without packaging
Ingress protection	Enclosure IP30, terminals IP10 according to DIN EN 60529 pollution degree 2 according to EN 61010-1:2011-07
Version	Enclosure protection class II according to DIN EN 61010
Housing	Flammability according to UL 94 V0 as declared by the manufacturer

Mechanical Construction	
EMV	EN 55022 Class B : 2010 + AC : 2011 EN 61000-3-2 : 2014 EN 61000-3-3 : 2013 EN 61000-6-3 : 2007 + A1 : 2011 EN 61000-6-2 : 2005 EN 61000-4-2 : 2009 EN 61000-4-3 : 2006 + A1 : 2008 + A2 : 2010 EN 61000-4-4 : 2012 EN 61000-4-5 : 2014 EN 61000-4-6 : 2014 EN 61000-4-8 : 2010 EN 61000-4-11 : 2004
Operating conditions	
Temperature range	0 °C...45 °C
Installation height	Geographical height max. 2000 m above sea level
Article-No.	20-10090 without system points
PC requirements for FRAKO-NET software package	
Hardware	<ul style="list-style-type: none"> • Min. Intel Core I5 • Main memory min. 4 GB RAM • 10 GB free hard drive space • Ethernet 10/100 Mbit/s network connection or/and one free serial interface • DVD drive • SVGA graphics adapter • Colour screen with minimum resolution of 1024 x 768
Software	<ul style="list-style-type: none"> • Microsoft® Windows®* 10 • Microsoft® Windows®* 7 (x32/x64) • Microsoft® Windows®* Server 2008 R2 • current browser for example, Mozilla Firefox <p>* Registered trademarks of Microsoft Corporation</p>

Optional accessories

Article-No.	Type	Description
20-10495	System points upgrading package	10 system points incl. system visualization EMVIS 3000
20-10496	PQM 1588	50 system points
20-10497		100 system points

System Components

Central Unit

1

System points per integrated device	Upper limits
30 System points per EM-MC 2200	Max. 4 units EM-MC 2200 per PQM 1588
15 System points per EM-PQ 2300	Max. 32 units EM-PQ 2300 per PQM 1588 in Slavemode, or max. 8 in Mastermode
15 System points per PQA 1101	Max. 32 units PQA 1101 per PQM 1588
5 System points per EMR 1100	Max. 32 units EMR 1100 per PQM 1588
7 System points per PQC (single phase)	
10 System points per PQC (three phase)	
7 System points per EM-PQ 1500	Max. 32 units EM-PQ 1500 per PQM 1588
1 System point per channel of EM-MC 2200, PQA 1101, EM-PQ, EMF 1102 or PQM 1588	Max. 550 metering-, analogue-, status- or alarm channels per PQM 1588
10 System points to activate the S0 function of the PQM 1588	

Web interface Start screen

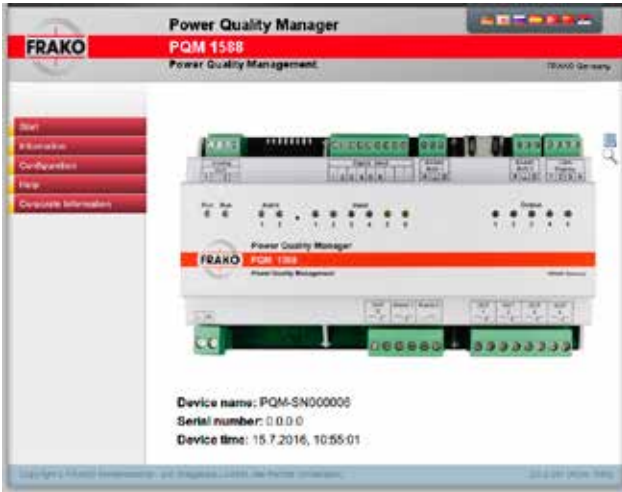

Web interface Main Configuration – IP address



Dimensions

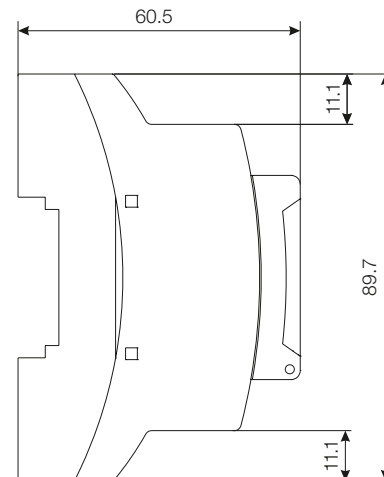
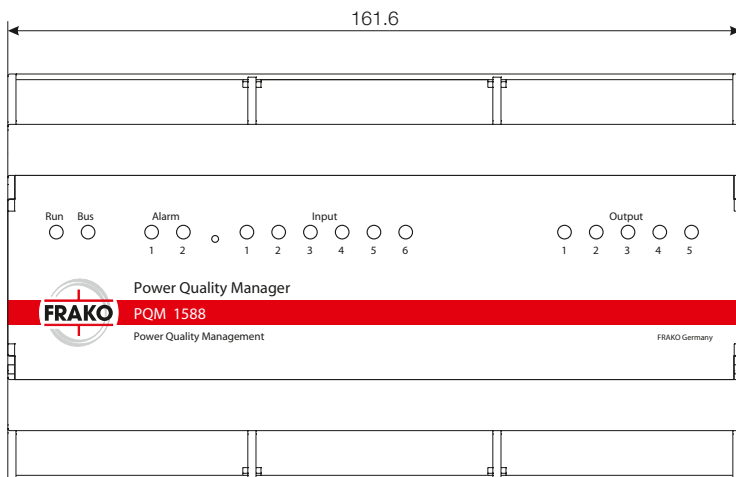

Dimensional drawing PQM 1588

All dimensions in mm

System Components

Gateways

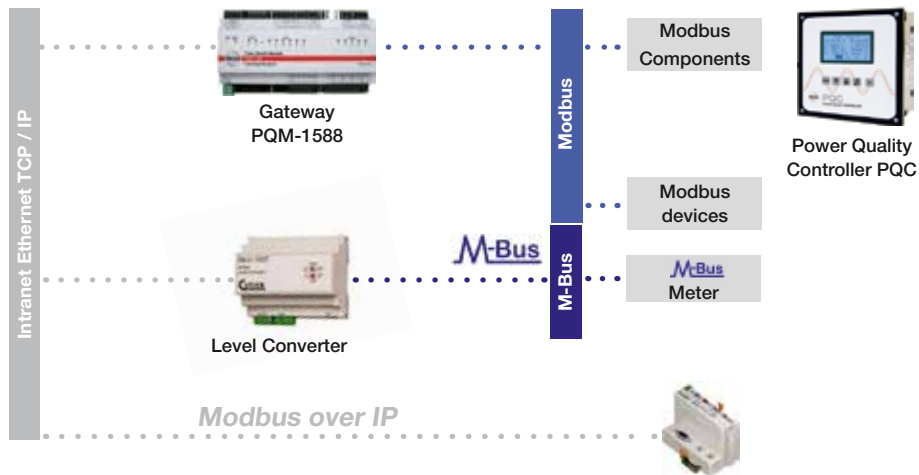

Gateways

For the connection of different bus systems for example Modbus, M-Bus, EIB/KNX etc. various bus couplers are available. Depending on the requirement the suitable bus coupler will be selected.

System Components

Gateways

1



System Components

Repeater

1



EMB 1101 Repeater

The repeater EMB 1101 is designed to process and distribute signals in the FRAKO Starkstrombus. It is necessary to use a repeater for lines with a length of over 1000 m and for bus systems where more than 32 instruments are served by one line. The EMB 1101 also allows to realize star topology.

Description

- Device for conditioning and distribution of signals
- Up to 120 instruments can be operated in a bus system
- The repeater is necessary for lines with a length of over 1000 m and for bus systems where more than 32 instruments are served by one line
- Installing the repeater improves the reliability of the bus system, especially under difficult operating conditions that cause interference
- Star wiring system; up to four lines, each connected to a maximum of 32 instruments, can be wired to one repeater
- Cascading repeaters enables bus lengths of up to 15 km to be installed
- Existing cable connections, which do not use a bus cable specified by FRAKO, can be used for distances of up to 4 km
- The repeater can electrically isolate sections of the bus system in order to prevent stray currents flowing in the FRAKO Starkstrombus
- In case of an electrical error in the connected lines, the error will be automatically detected and displayed, and the corresponding line will be closed
- Data transmission errors are automatically detected and signalled by an LED

System Components

Repeater

1

Technical Data

Power supply	
Supply voltage	60 V - 230 V + 15 % AC or DC
Frequency	If AC: 48 up to 62 Hz
Power consumption	Approx. 6 VA
Fuse protection	Max. 2 A external prescribed
In- / Outputs	
Quantity	4 lines, thereof 1 line galvanically separated
Protocol	FRAKO Starkstrombus, according to EN 50170 (P-Net), standardized fieldbus, RS-485; transfer rate: 76.8 kbit/s
Display elements	
Operating (Run)	One blinking green LED
Data transfer	One green and red LED per line
Connections	Screw terminals Wire cross-section: max. 2.5 mm ²
Mechanical construction	
Dimensions	140 x 90 x 59 mm (W x H x D), DIN module case 8 HP
Ingress protection	Housing IP40, terminals IP20
Version	According to VDE 0411 protection class II (also DIN EN 61010-1)
Housing	PC with 10 % GF, V-0, flammability to UL-94 V-0
Installation	On standard rail 35 mm according to DIN EN 50022
Mounting position	Optional
Weight	Approx. 0.6 kg
Operating conditions	
Ambient temperature	0 °C up to +50 °C
Article-No.	20-10600

Dimensions

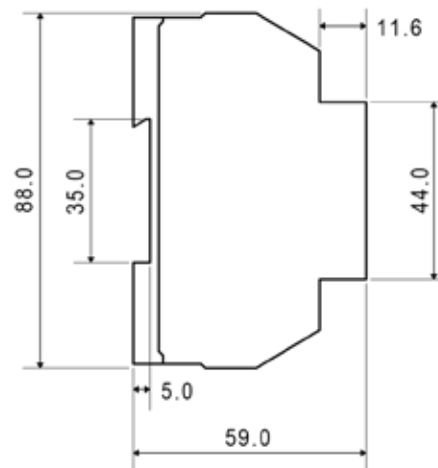
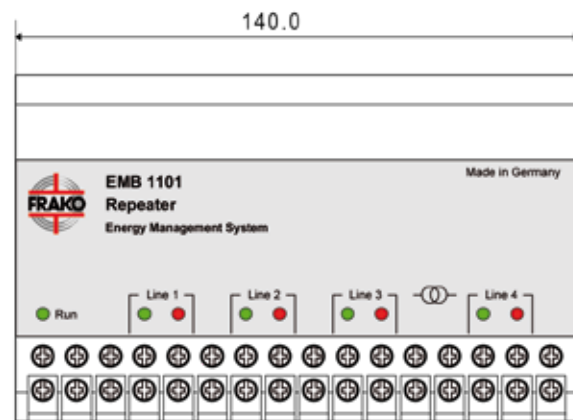

Dimensional drawing EMB 1101

All dimensions in mm

System Components

Repeater



Maximum Demand Control

2 **Maximum Controller**

Page 241

Switching Module

Page 247

Maximum Demand Control

Maximum Controller



2

EM-MC 2200 Maximum Controller

The contemporary styling of the EM-MC 2200 Maximum Controller accentuates its user-friendly energy management technology. It reduces power demand peaks with new additional functions. The self-adapting target demand function provides dynamic adjustment to the site's monthly operating characteristics. Reducing target demand at the beginning of the accounting period, together with automatic self-adaptation, enables additional savings to be made in months with lower demand peaks.

Designed to work as a stand-alone unit, the EM-MC 2200 is the ideal solution for small to medium-sized industrial and commercial operations, office buildings and hotels. With the FRAKO Starkstrom-bus or an ethernet interface it can be integrated into a FRAKO Energy Management System.

Switching off loads by intelligent terminals (Modbus over IP) or timers is only one of the helpful new features of the EM-MC 2200.

This is an investment with a short payback time even in the deregulated energy market, since exceeding the specified power peak limit still results in extra costs that can be avoided.

Description

Special contract customers whose demand exceeds the agreed maximum (subscribed demand) will face increased costs through entering a higher demand category.

Do you know how many measurement intervals there are in a year?

There are some 35 000 measurement intervals in a year, or about 2 900 in a month. As a rule, the calculation determining the price paid for power in a given month is based on the measurement interval with the greatest demand in that month.

The Maximum Controller EM-MC 2200 can help you to stay within

the set limits, since this unit cuts demand peaks by shedding those loads assigned a low priority or not considered absolutely essential. Loads are switched off for a short time whenever the subscribed demand appears likely to be exceeded. An individual order of priorities for switching loads off ensures that normal operation can continue without disruption despite this load shedding. The result: Instead of having to pay a higher maximum demand charge, the subscribed demand can even be reduced – and thus save costs!

The modular construction of the EM-MC 2200 makes it both simple and inexpensive to install. It is upgradable at any time by software updates and connecting local EMD 1101 add-on units.

Operation is of proven simplicity with a clear, menu-driven operator dialogue in plain language at the EM-FD 2500 display or by accessing the instrument from a PC.

The scope of supply includes the Device Manager software. This is used to enter and modify parameters and to display—or when needed print out—daily demand curves, load operating times and all basic and load-specific settings.

- Control of demand to limit the average power consumption in a

Maximum Demand Control

Maximum Controller

given interval to the set target demand. This is achieved by temporarily switching off individual loads

- Monitoring of demand peaks: if demand is too high, loads are immediately switched off to prevent the circuit breaker tripping
- Power-dependent control application point to prevent unnecessary load shedding at the start of the measurement
- Individual adjustment of the connected loads to suit operating conditions by setting priorities, min./max. OFF times and min. ON times per channel
- 4 profiles can be activated. Target demand and peak power, together with the load parameters priority, power, min./max. OFF times, min. ON times and priority type (time or power priority), can be set for each profile
- To make best use of seasonal demand fluctuations, the self-adapting target demand adjusts itself dynamically to suit the operating conditions of the month concerned. Reducing the target demand at the beginning of the accounting period combined with automatic self-adaptation makes additional savings possible in months with low peak loads
- Formation of switching channel groups for strict compliance with the set priorities
- 'Traffic light' function: 3 switching channels can be used for signal lamps as a visual guide to demand conditions
- Emergency load-shedding mode for keeping within maximum demand even with critical load constellations
- Connection of any desired Modbus TCP device with digital outputs to switch off loads (e.g. WAGO fieldbus controller with I/O terminals, SIEMENS PAC4200 with DI/DO module, plus many more). It is a prerequisite that the function codes 5 or 6 are supported. It is a prerequisite that the function codes 5 or 6 are supported.
- Timer for switching loads to a time schedule or to set time-scheduled target demands or profiles
- Storage of the following data in a ring memory:
 - Average values per interval over 20 000 intervals including the target power applicable at the end of the interval and time stamp
 - Daily maximum values over 500 days including time stamp
 - Monthly maximum values over 48 months
 - 10 000 switching cycles
- Configuration and presentation of momentary and historical measurement readings using the Device Manager software (included in scope of supply)
- Display of measurement readings and the power factor triangle (trend curve) via an integrated web interface or an EM-FD 2500 display, an optional graphic display instrument connected to the EM-MC 2200 Maximum Controller by a 4-core cable. Up to 7 additional EM devices can be viewed on one EM-FD 2500 display.

2

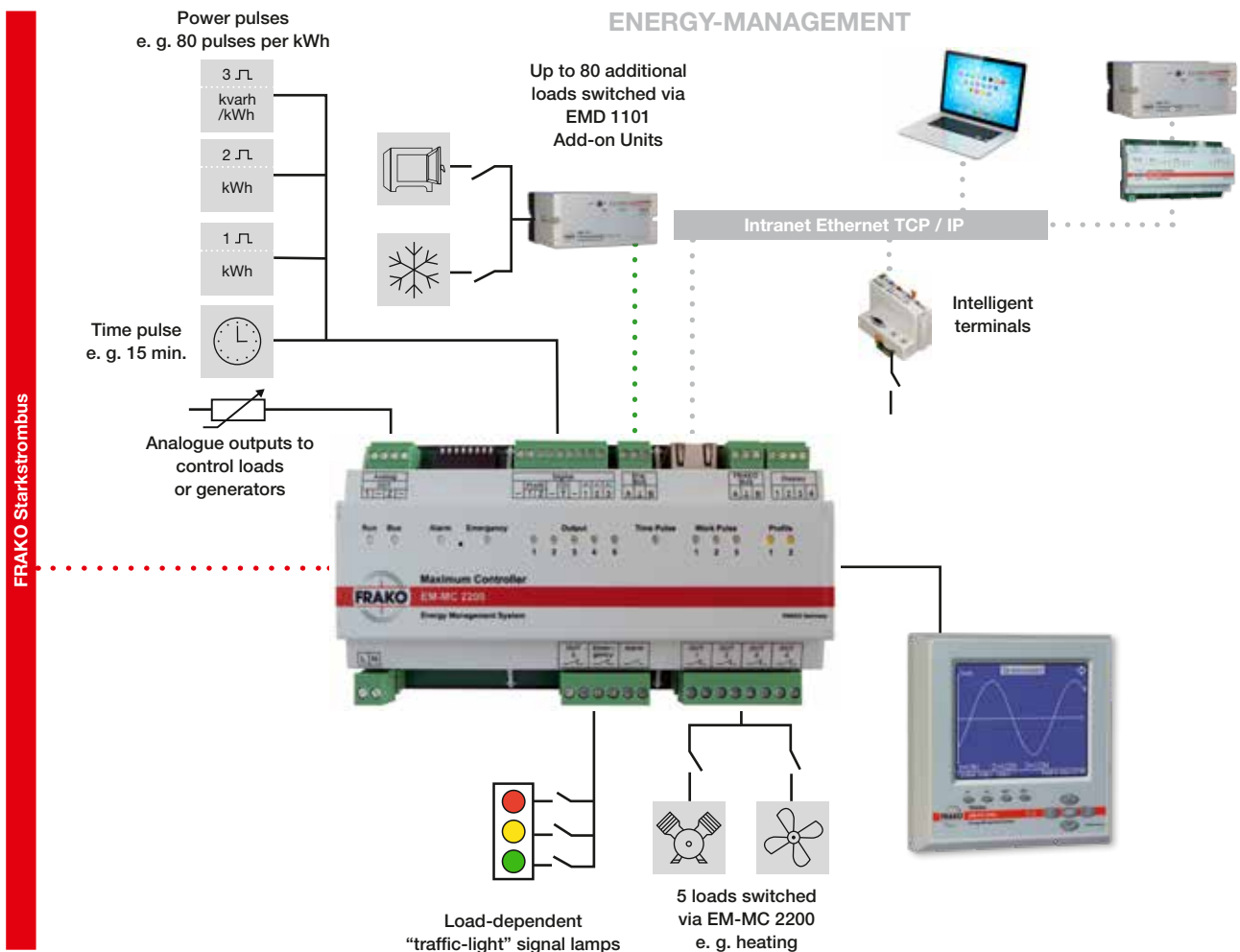

Maximum Demand Control

Maximum Controller

• Inputs:

- 3 inputs for active energy pulses or 2 for active and 1 for reactive energy pulses. These can be added, subtracted or used as meters. The self-adapting target demand function can be reset via a volt-free contact
- 1 input for time pulse; interval duration adjustable from 1 to 1 440 minutes
- 2 inputs for activating the 4 profiles. These adjust the target demand and/or the settings of the connected loads to suit site-specific factors such as regular and off-peak tariffs. Profile switching can be by the internal timer or an input to the EMF 1102 Cost Centre and Alarm Unit

• Outputs:

- 5 switching and 1 emergency load-shedding channel in the basic instrument (decentralized extendability: up to 85 switching channels possible by means of EMD 1101 add-on units, each with 8 relay contacts)
- 1 alarm contact to signal faults (alarm signal also possible at any desired output)
- 2 analogue outputs for 2 measurement readings (momentary, trend, target or corrective power, capacity utilization or remaining time) as 0/4–20 mA or 0–10 V signals, or for infinitely variable control of loads; fed by internal power supply

• Interfaces:

- RS-485 bus, FRAKO Starkstrombus protocol to connect to the FRAKO Energy Management System
- RS-485 extension bus to connect EMD 1101 add-on units
- Ethernet (RJ 45 jack) with the following functions:
 - Communication with the EMD 1101 add-on unit or the EMF 1102 Cost Centre and Alarm Unit via the PQM 1588
 - Output of switching commands also via Modbus TCP
 - Communication with the PQM 1588 Central Unit
 - Communication with the configuration software at the PC

- The software (Device Manager) for configuring and displaying the saved measurement readings via Ethernet is included with the instrument

Easy installation with the DIN rail-mounted enclosure

The EM-MC 2200 is housed in an enclosure with a pin strip

underneath it.

This system, consisting of pin and socket strips and DIN rail bus connectors, enables the individual modules to be easily fitted and connected to one another.

All connections are also available at external terminals for conventional wiring. Use of the 16-pin DIN rail bus connector provides automatic contact from instrument to instrument.

The bus connector enables the FRAKO Starkstrombus, extension bus and display bus to be connected. The pin and socket strips on

the DIN rail ensure quick and easy installation of the instruments in parallel.

It is possible to plug individual instruments in or remove them without dismantling the modular assembly.

Data display on the EM-FD 2500

The EM-FD 2500 display has been developed as a physically sepa-



Maximum Demand Control

Maximum Controller

rate LCD display and operator panel to work with all FRAKO Energy Management devices of the new generation that require this, such as the EM-PQ 2300 and EM-MC 2200 instruments. The display is connected to the EM instrument via 4 terminals: two wires for the instrument power supply and two for data transfer. A maximum of 8 instruments can be connected to a common display bus, with a bus length of up to 40 m to the display. The display is mounted on the control cabinet door or wall through a $\varnothing 22.5$ mm hole, thus greatly simplifying installation. Its orientation is fixed by a screw through the wall into a threaded bush. Alternatively, the display can also be mounted in any available 144 x 144 mm cut-out. For this purpose suitable adapters are available.

Data display via the integrated web interface

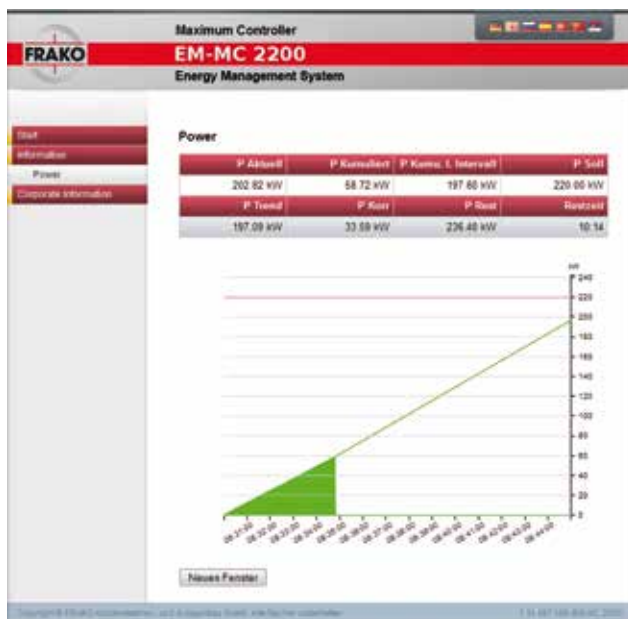

- Web server for the configuration and online display of all measurement readings
- Each user at any PC can view the most important measurement data via the intranet.

Device Manager –

Clear overview and straightforward programming

• Configuration

Configuration of the EM-MC 2200 is divided into two areas termed setting and configuration to distinguish them:

– Setting:

Setting covers all those adjustments that are necessary when commissioning the instrument itself or introducing add-on units.

– Configuration:

Configuration covers those adjustments that may have to be changed during ongoing operation.

The loads can be configured in a table giving a clear overview.

Settings for the individual profiles can be hidden, if desired, to simplify this overview. Channels can be copied and their settings adopted in total or per channel for all profiles.

• Trend display

Device Manager is a convenient tool for displaying real-time parameters such as momentary power, cumulative power, the remaining time in the current measurement interval and the power triangle. In addition, the statuses of the loads, the current profile (regular/off-peak tariff) and the limit settings are displayed. Any alarms or faults present are immediately apparent.

• Switched status log

Maximum Demand Control

Maximum Controller

The switched status log offers a graphical display of the last 10 000 changes in the switched status of up to 85 controlled switching channels.

- **Documentation**

The power demand in every measurement interval over the past 200 days is displayed as a chart and documented. Similarly, the demand peaks of the past 500 days and the past 48 months are saved, as are the switched statuses of up to 10 000 switching cycles. It is also no problem to export these recorded data to a spreadsheet program such as Excel.

- **Timer**

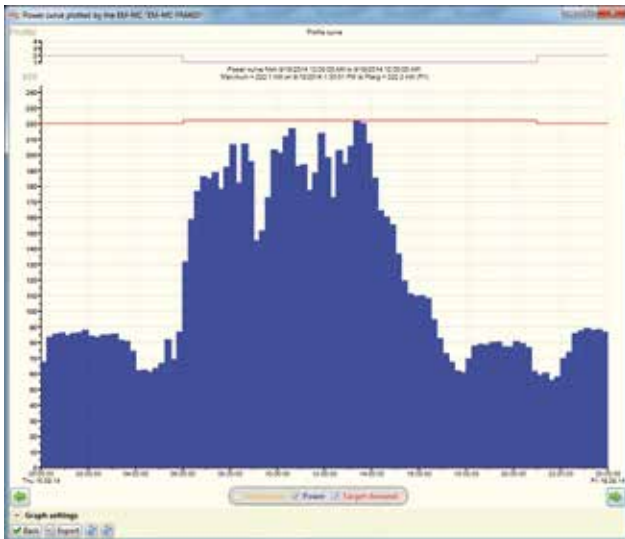

A weekly timer function is incorporated in the EM-MC 2200. This makes up to 400 switching times available, in order to change the status of switching channels to 'Permanently ON', 'Permanently OFF' or 'Controlled' at scheduled times. In the 'Controlled' condition, the EM-MC 2200 controls the actual condition of the load through the target demand control function and the peak demand monitoring function.

In addition, the profile and the target demand can be controlled by the timer.

Technical Data

Power supply	
Supply voltage	100 V – 253 V AC or 100 V – 230 V DC
Frequency	45 up to 65 Hz
Power consumption	7 W / 18 VA
Overcurrent protection	Max. 2 A external fuse required
Inputs	
General	<ul style="list-style-type: none"> • S0 interfaces (DIN 43864) to connect volt-free contacts • Voltage with contact open: 15 V • Max. line resistance: 800 Ohm • Short circuit current: 18 mA • Pulse frequency: 0.1 to 20 Hz
3 Pulse inputs	To acquire the power data from 3 meters with pulse outputs. Input 3 can also be used for the acquisition of reactive power data.
1 Time pulse input	1...1 440 minutes
2 Profile switch inputs	To select from 4 profiles
Measurement data storage	

	256 MB onboard flash memory
Outputs	
5 Relay contacts (switching channels)	Bistable, 250 V / 2 A AC or 30 V / 2 A DC
1 Relay contact (emergency load shedding)	Bistable, 250 V / 2 A AC or 30 V / 2 A DC
1 Alarm contact	NC 250 V / 2 A AC or 30 V / 2 A DC
1 Extension bus interface	<ul style="list-style-type: none"> • To connect up to 10 EMD 1101 • Modbus TCP output instruments (fieldbus instruments, function code 5)
2 Analogue outputs	0-10 V / 0-20 mA / 4-20 mA + Steuerung-Verbraucher
'Traffic light' signal lamps	Visual guide to demand conditions

Maximum Demand Control

Maximum Controller

2

Technical Data

Interfaces	
1 FRAKO Starkstrombus interface	To connect to the FRAKO Energy Management System
1 Display bus interface	Optional connection of to up to 2 external EM-FD 2500 display instruments
Web server / E-mail / SNMP	• / • / •
Display and operation, connections	
User interface Art.-No. 20-30240	Operation via external EM-FD 2500 display instrument
Alarm system	•
Timer function	•
Annunciators	15 LEDs
Connections	Pin and socket strips; max. core cross section: max. 1.5 mm ²
Mechanical construction	
Dimensions	161.6 x 89.7 x 60.5 mm (W x H x D)
Ingress protection	IP30 (enclosure), IP10 (terminals)
Weight	Approx. 0.4 kg
Protection class	Class II according to EN 61010
Enclosure	Flame retardant UL 94-V0
Mounting	On standard 35 mm DIN rail according to EN 50022
Operating conditions	
Ambient temperature	0 °C up to +45 °C
Article No.	20-20071

Technical Data

PC requirements to run Device Manager	
Hardware	<ul style="list-style-type: none"> • PC: CPU mit with at least 2 GHz • 1 Gbyte RAM • 200 Mbyte free hard disc space
Software	<ul style="list-style-type: none"> • Microsoft® Windows® XP, SP 2 with installed .NET-Framework 3.5 • Microsoft® Windows® 7 (32 or 64 Bit) • Microsoft® Windows® 2008 Server R2 <p>* Registered trademark of Microsoft Corporation</p>

Dimensions

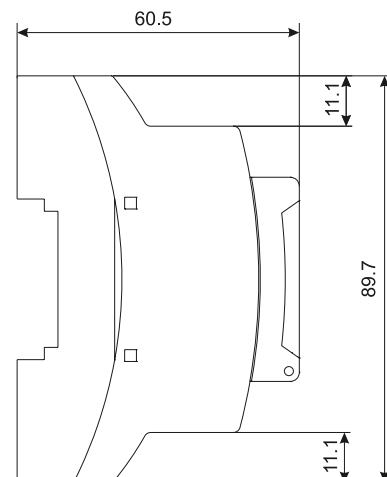
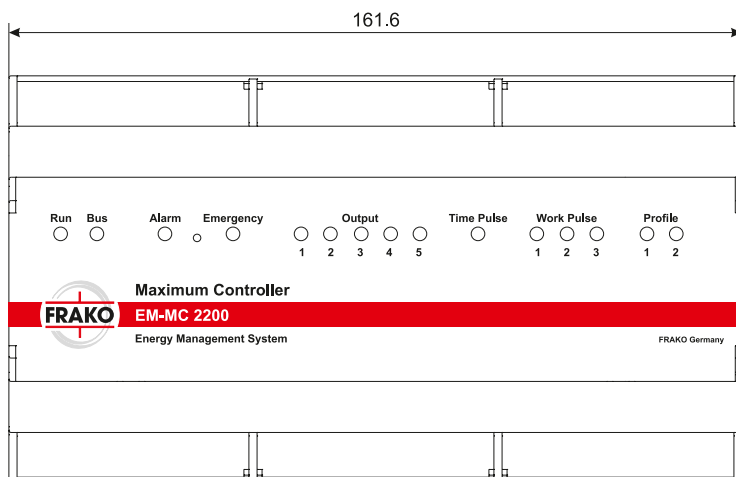

All dimensions in mm

Maximum Demand Control

Switching Module



2

EMD 1101 Switching Module

Switching module with 8 switching channels for connection to the extension bus or the FRAKO Starkstrombus.

The extension module with 8 switching channels can be connected selectively to:

- Maximum Controller EM-MC 2200 or Maximum Demand Controller EML 1101
- System Timer EMT 1101 via FRAKO Starkstrombus

Description

- Display of the switching status via LED
- LED display for bus access
- Definition of the switching status (on/off) of the individual switching channels in case of a failure.

Maximum Demand Control

Switching Module

2

Technical Data

Power supply	
Mains voltage	230 V AC -15 % up to +10 %
Frequency	45 up to 65 Hz
Power consumption	4 VA
Fuse protection	Max. 2 A external prescribed
Outputs	
8 switching channels	Normal open contact 250 V AC / 4 A
1 extension bus / FRAKO Starkstrombus	2-wire-fieldbus, RS-485
Operating elements	8-fold DIP switching series, 10-level rotary switch
Display elements	9 LEDs
Connections	Via plug-in connector blocks within housing; conductor cross-section: max. 2.5 mm ²
Mechanical construction	
Dimensions	158 x 75 x 120 mm (W x H x D)
Ingress protection	IP40
Version	Protection class 2 according to DIN EN 61010
Housing	Flammability to UL94-V0 (according to the manufacturer)
Installation	Screw mounting or on standard rail 35 mm according to DIN EN 50022
Weight	Approx. 0.8 kg
Operating conditions	
Ambient temperature	0 up to +45 °C
Storage temperature	-20 up to +60 °C
Article-No.	20-21002

Dimensions

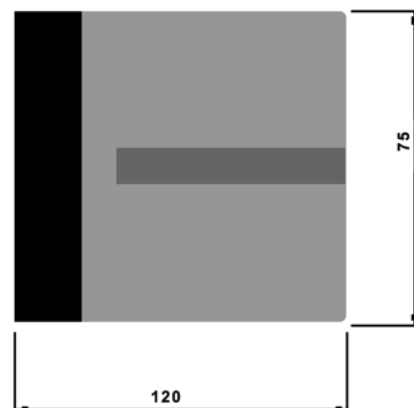
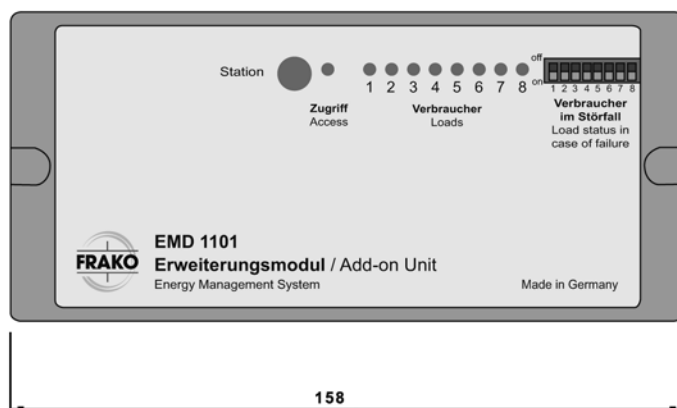

Dimensional drawing EMD 1101

All dimensions in mm

Maximum Demand Control

Switching Module



Cost Allocation / Cost Centre Acquisition

Electronic Energy Meter

Page 251

Cost Centre and Alarm Unit

Page 257

Acquisition of Process Data

Page 259

Cost Allocation / Cost Centre Acquisition

Electronic Energy Meter



3

M3PRO 80 MID, M3PRO 80 MID M-Bus, M3PRO 80 MID ModBus, M3PRO 1-5 MID, M3PRO 1-5 MID M-Bus, M3PRO 1-5 MID ModBus and IME Conto D4 Electronic Energy Meter

Electronic energy meter for measuring active and reactive energy.



Description

Electronic energy meters for measuring active and reactive energy, available with direct measurement or for operation with voltage/current transformer. Impulse outputs for active and reactive energy or regenerated active energy. Depending on the type of meter, electrical parameters such as I, V, F and PF as well as P, Q, S will be displayed. Data transmission via additional communication modules is possible.

Cost Allocation / Cost Centre Acquisition

Electronic Energy Meter

3

Type		IME Conto D4Pt-CE4DT12A2	M3PRO 80 MID
Technical data			
Article No.		29-20155	29-20170
Measurement	active energy / reactive energy consumed	• / •	• / •
	active energy / reactive energy regenerated	- / -	• / •
Approval		-	calibrated (MID)
Accuracy class		-	-
Connection type		3-wire	4-wire
Current measurement	Current transformer x / ..	5 A	-
	Direct input up to	-	80 A
	Power draw	0.7 VA/Phase	0.7 VA/Phase
	Input currents galvanically isolated	•	-
Voltage measurement	Voltage circuit	3x 57.7 / 100 V	92...276 / 160...480 V
	Ratio of current transformer	1...1500.0	-
	Power draw	1.5 VA	2 VA
	Frequency	50 Hz	50 Hz
Voltage supply		self-supplied from voltage input	
Standard S0 pulse output (volt-free contact)	Number/use	1/active energy consumed or 1/reactive energy consumed	1/active energy consumed T1 and T2 1/reactive energy consumed T1 and T2
	Valency	10 Wh, 100 Wh, 1 kWh 10 kWh, 100 kWh, 1000 kWh	1, 2, 5, 10, 20, 50, 100, 200 per kWh
	Pulse duration	50, 100, 200, 300, 400, 500 ms	30...100 ms
	Contact load	110 V DC/AC / 50 mA	3...28 V AC / 90 mA, 3...39 V DC / 90 mA
	LED	10 000 Imp/kWh	1 000 Imp/kWh
LC-Display	backlit	•	•
Bus connection		-	-
Detection of faulty connections		•	•
Tariffs		2	2
Ingress protection	Enclosure	IP54	IP51
	Terminal block with cover	IP20	IP40
Input cable cross section	Current transformer	4 mm ²	-
	Direct	-	33 mm ²
Dimensions	(W x H x D) [mm]	122.5 x 100 x 58.5	72 x 90 x 64
	Width in HP	4	4
Mounting	35 mm DIN rail	•	•
Weight		260 g	412 g
Operating temperature		-5 ... +55 °C	-25 ... +55 °C
Special features		Resettable intermediate meter; Instantaneous and maximum active power	1 pulse each for imported active and reactive energy; infrared interface to connect communications module for Modbus / M-Bus

Cost Allocation / Cost Centre Acquisition

Electronic Energy Meter

Type		M3PRO 1-5 MID	M3PRO 1-5 MID M-Bus	M3PRO 80 MID M-Bus
Technical data				
Article No.		29-20171	29-20172	29-20173
Measurement	active energy / reactive energy consumed	• / •	• / •	• / •
	active energy / reactive energy regenerated	• / •	• / •	• / •
Approval		calibrated (MID)	calibrated (MID)	calibrated (MID)
Accuracy class		B	B	B
Connection type		4-wire	4-wire	4-wire
Current measurement	Current transformer x / ..	1 A / 5 A	1 A / 5 A	–
	Direct input up to	–	–	80 A
	Power draw	0.7 VA/Phase	0.7 VA/Phase	0.7 VA/Phase
	Input currents galvanically isolated	•	•	–
Voltage measurement	Voltage circuit	92...276 / 160...480 V	92...276 / 160...480 V	92...276 / 160...480 V
	Ratio of current transformer	–	–	–
	Power draw	2 VA	2 VA	2 VA
	Frequency	50 Hz	50 Hz	50 Hz
Voltage supply		self-supplied from voltage input		
Standard S0 pulse output (volt-free contact)	Number/use	1/active energy consumed T1 and T2 1/reactive energy consumed T1 and T2	–	–
	Valency	abhängig von Stromwandlerverhältnis und Impulsdauer	–	–
	Pulse duration	30...100 ms	–	–
	Contact load	3...28 V AC / 90 mA, 3...39 V DC / 90 mA	–	–
	LED	1 000 Imp/kWh	1 000 Imp/kWh	1 000 Imp/kWh
LC-Display	backlit	•	•	–
Bus connection		–	RS 485 / M-Bus	RS 485 / M-Bus
Detection of faulty connections		•	•	•
Tariffs		2	2	2
Ingress protection	Enclosure	IP51	IP51	IP51
	Terminal block with cover	IP40	IP40	IP40
Input cable cross section	Current transformer	4mm ²	4mm ²	–
	Direct	–	–	33 mm ²
Dimensions	(W x H x D) [mm]	72 x 90 x 64	72 x 90 x 64	72 x 90 x 64
	Width in HP	4	4	4
Mounting	35 mm DIN rail	•	•	•
Weight		335 g	335 g	335 g
Operating temperature		-25 ... +55 °C	-25 ... +55 °C	-25 ... +55 °C
Special features		1 pulse each for imported active and reactive energy; infrared interface to connect communications module for Modbus / M-Bus	M-Bus interface for direct connection with the PQM 1588 via M-Bus coupler	

Cost Allocation / Cost Centre Acquisition

Electronic Energy Meter

3

Type		M3PRO 1-5 MID ModBus	M3PRO 80 MID ModBus
Technical data			
Article No.		29-20174	29-20175
Measurement	active energy / reactive energy consumed	• / •	• / •
	active energy / reactive energy regenerated	• / •	• / •
Approval		calibrated (MID)	calibrated (MID)
Accuracy class		B	B
Connection type		4-wire	4-wire
Current measurement	Current transformer x / ..	1 A / 5 A	–
	Direct input up to	–	80 A
	Power draw	0.7 VA/Phase	0.7 VA/Phase
	Input currents galvanically isolated	•	–
Voltage measurement	Voltage circuit	92...276 / 160...480 V	92...276 / 160...480 V
	Power draw	2 VA	2 VA
	Frequency	50 Hz	50 Hz
Voltage supply		self-supplied from voltage input	
Standard	Number/use		–
S0 pulse output (volt-free contact)	Valency		–
	Pulse duration		–
	Contact load		–
	LED	1 000 Imp/kWh	1 000 Imp/kWh
LC-Display	backlit	•	•
Bus connection		RS 485 / M-Bus	RS 485 / M-Bus
Detection of faulty connections		•	•
Tariffs		2	2
Ingress protection	Enclosure	IP51	IP51
	Terminal block with cover	IP40	IP40
Input cable cross section	Current transformer	4 mm ²	–
	Direct	–	33 mm ²
Dimensions	(W x H x D) [mm]	72 x 90 x 64	72 x 90 x 64
	Width in HP	4	4
Mounting	35 mm DIN rail	•	•
Weight		335 g	412 g
Operating temperature		-25 ... + 55 °C	-25 ... + 55 °C
Special features		Modbus interface for connection via Modbus RTU directly to the PQM 1588	

Cost Allocation / Cost Centre Acquisition

Electronic Energy Meter

Optional Accessories

Article-No.	Type	Description
29-20104	ECS MODBUS RTU	Modbus communication module. The communication between the module and the energy meter is realized via the infrared interface. Values: energy and power U, I, PF and F.
29-20105	ECS M-Bus	M-Bus communication module. The communication between the module and the energy meter is realized via the infrared interface. Values: energy and power U, I, PF and F.
29-20121	ECS SD-Card Data logger	SD Card data logger with SD Card. The communication between the module and the energy meter is realized via the infrared interface.

Please note that optional accessories are available for all energy meters except for IME Conto D4 Pt-CE4DT12A2.

Cost Allocation / Cost Centre Acquisition

Electronic Energy Meter

Dimensions

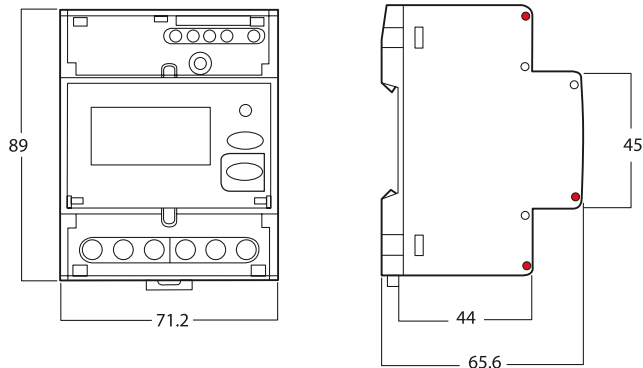

Dimensional drawing IME Conto D4

3

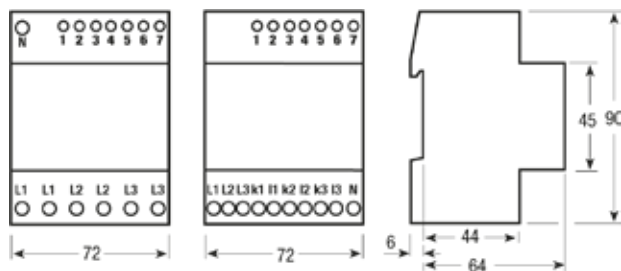

Dimensional drawing

M3PRO 1-5 MID, M3PRO 1-5 MID M-Bus,
M3PRO 1-5 MID ModBus, M3PRO 80 MID,
M3PRO 80 MID M-Bus, M3PRO 80 MID ModBus

All dimensions in mm

Cost Allocation / Cost Centre Acquisition

Cost Centre and Alarm Unit



3

EMF 1102 Cost Centre and Alarm Unit

The EMF 1102 is a compact and cost-effective system for the acquisition and storage of meter readings, switching status and alarm signals.

Description

It consists of a data acquisition and memory unit plus modular software components for easy user configuration and for the evaluation and management of the data. Remote alarms can be transmitted by SMS via modem.

The EMF 1102 can be used as a stand-alone system for the acquisition of utilities and operating data in a factory or other premises, or can be installed as an integral part of a FRAKO Energy Management System.

Data acquisition for all types of utility such as electricity, water, gas, compressed air or meter pulse inputs via an S0 interface (= digital inputs).

- Calculation of power, energy and flow rates
- Monitoring of power, energy or flow rate with high and low alarm settings
- Determination of running time and downtime for each channel (running time meter)
- Operating cycle counter
- Monitoring of running times and downtimes with alarm settings (e.g. to detect instrument failure)
- Monitoring of key operating conditions
- Remote alarms by SMS in an event of system faults or if monitored variables exceed critical limits
- Storage of all utility data with memory for several days
- Connection: via RS-232 adapter with modem or COM server or direct to PC or via FRAKO Starkstrombus to the EMP communication processor or the PQM 1588 Power Quality Manager
- Option of visualising and evaluating the meter data via the FRAKO Energy Management System software module (EMVIS 3000)
- Option of displaying, configuring and evaluating the recorded data via the PC by means of the EMF-SW cost centre and alarm software EMF-SW (optional)

Cost Allocation / Cost Centre Acquisition

Cost Centre and Alarm Unit

3

Technical Data

Power supply	
Mains voltage	230 V AC +/- 10 %
Frequency	45 to 65 Hz
Power consumption	Approx. 10 VA
Inputs	
General	S0-Interfaces (DIN 43864) for connection of potential-free contacts, common 'E'-Potential switching time: >= 25 ms Voltage with open contact: 12 V DC +/- 10 % Short circuit current: 12 mA +/- 10 %
12 Pulse Inputs	Pulse frequency: max. 20 Hz Internal shifter shafts: 'Off' at approx. 3 mA, 'On' at approx. 7.5 mA
Outputs	
1 Voltage output	12 V DC, max. 50 mA
Interfaces (mode can be selected)	
1 FRAKO Starkstrombus	For connection to FRAKO Energy Management System, according to EN 50170 (P-Net), standardized fieldbus, RS-485 Transfer rate: 76.8 kbit/s
RS-232 Interface	Optional via RS-232 Adapter direct connection to PC Transfer rate: 19 200 Baud
Display elements	14 LEDs
Connections	Screw terminals Conductor cross-section: max. 2.5 mm ²
Mechanical construction	
Dimensions	140 x 90 x 59 mm (W x H x D), DIN module cases 8 HP
Ingress protection	Housing/Terminals IP40/20
Version	Protection class II according to VDE 0411 / DIN EN 61010-1
Housing	flame retardant UL94-V0
Installation	on standard rail 35 mm according to DIN EN 50022
Mounting position	Optional
Weight	Approx. 0.6 kg
Operating conditions	
Ambient temperature	0 °C up to +60 °C
Article-No.	20-40005

Optional Accessories

Article-No.	Type	Description
20-10310	EM-RS 232	RS-232 Adapter for direct access via PC to the data of EMA 1101 (SW-Version 1.11*), EMR 1100 (SW-Version 1.95*) and EMF 1102 (SW-Version 1.0*)
20-10309	EM-RS 232 for modem operation	RS-232 Adapter for direct access via PC to the data of EMA 1101 (SW-Version 1.11*), EMR 1100 (SW-Version 1.95*) or EMF 1102 (SW-Version 1.0*) via modem
20-10319	Registration license EMF 1102	License allows EMVIS 3000 access to a Cost Centre and Alarm System EMF 1102, if this is logged by using a virtual data collector.
20-10313	EMF-SW	Display, analysis and configuration software for Cost Centre and Alarm System EMF 1102. Access via: PQM 1588 and RS-232 adapter. Note: included in scope of delivery of FRAKO-NET (for CD delivery)

* or higher

Dimensions

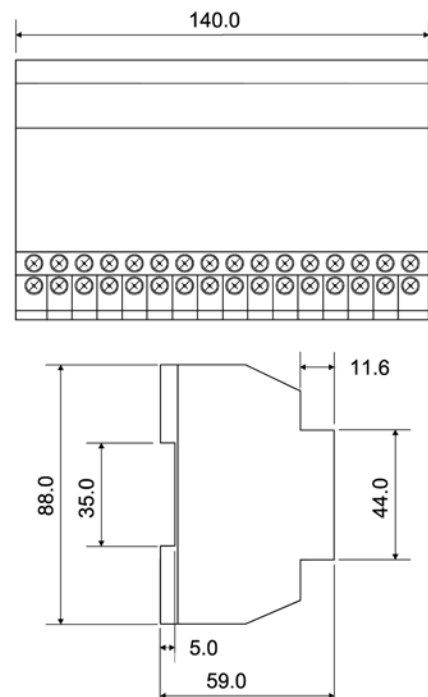

Dimensional drawing EMF 1102

All dimensions in mm

Cost Allocation / Cost Centre Acquisition

Acquisition of Process Data



3

EM-UIF / EM-PTF Frequency-Converter

The pulse output of the Frequency-Converter is connected to the Cost Centre and Alarm System EMF 1102. This offers the possibility to control, detect and visualize sensors with arbitrary output signals and temperatures with the FRAKO Energy Management System.

EM-UIF

Voltage-/Current-/Frequency Converter

For operating data acquisition of analogue signals with the FRAKO Energy Management System.

EM-PTF

Temperature-/Frequency-Converter

For acquiring operating data with the FRAKO Energy Management System, the measured inlet temperatures from -40 °C to $+120\text{ °C}$ will be transformed into a pulse frequency from 0 to 5 Hz.

Cost Allocation / Cost Centre Acquisition

Acquisition of Process Data

Technical Data EM-UIF

Power Supply	
Mains voltage	230 V AC +/-20 %
Frequency	45 up to 65 Hz
Power consumption	2.5 VA
Input	
Input variable	DC current or DC voltage
Rated voltage	0-20 mA, 4-20 mA, $R_i = 3 \Omega$ 0-10 V, 2-10 V, $R_i = 160 k\Omega$
Overloading continuously	2 times at current 5 times at voltage
Surge overload	Twenty times 1 sec at current five times at voltage
Output	
Rated value	0 up to 5 Hz
OPEN collector	npn, max. 30 V, 100 mA max. loadable
Ingress protection	IP40
Version	Housing insulated, protection class 2, at rated voltage up to 300 V (net to neutral conductor), pollution degree 2, according to DIN EN 61010 Part 1 EMV according to DIN EN 50081-2 and DIN EN 61000-6-2
Installation	On standard rail 35 mm according to DIN EN 50022
Operating conditions	
Ambient temperature	-15 °C up to +55 °C
Article-No.	29-20059

Technical Data EM-PTF

Power supply	
Mains voltage	230 V AC +/-20 %
Frequency	45 bis 65 Hz
Power consumption	2.5 VA
Input	
Input variable	Resistor PT100
Rated value	-40 °C up to 120 °C, constant current via the sensor 2 mA
Types of connection	2-/3-or 4-wire, can be selected by DIP switch
2-wire circuit	Lead max. adjustment 10 Ohm via built-in potentiometer
3-wire circuit	Lead max. 100 Ohm, balanced, no adjustment required
4-wire circuit	Lead max. 100 Ohm, no adjustment required
Output	
Rated value	0 up to 5 Hz
OPEN collector	npn, max. 30 V, 100 mA load
Pulse / Pause	50/50 %
Connections	Screw terminals Conductor cross-section: max. 4 mm ²
Mechanical construction	
Dimensions	22.5 x 84 x 108 mm (W x H x D)
Ingress protection	Housing/terminals IP30/IP20 according to DIN EN 60529
Version	Insulated housing, degree of pollution 2, overvoltage category CAT 3 according to DIN EN 61010 part 1, EMV according to DIN EN 50081-1, DIN EN 61000-6-2
Installation	On standard rail 35 mm according to DIN EN 50022
Weight	Approx. 0.15 kg
Operating conditions	
Ambient temperature	-15 °C up to +55 °C
Article-No.	29-20049

Cost Allocation / Cost Centre Acquisition

Acquisition of Process Data

Dimensions

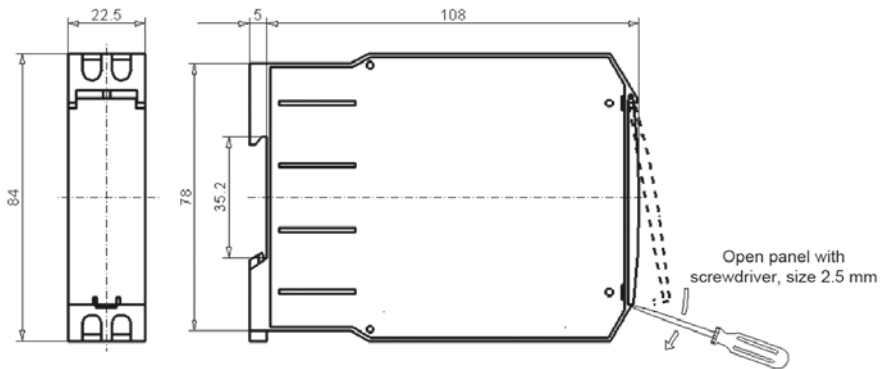

Dimensional drawing EM-UIF, EM-PTF

All dimensions in mm

Accessories

EM-PT 100 Temperature Sensor

Temperature sensor in 4-wire technique for measuring temperatures using the Temperature-/Frequency-Converter EM-PTF, for devices with PT100 input1.



Technical Data

General	
Rated value	100 Ohm at 0 °C
Temperature range	-80 °C up to +260 °C
Material	Stainless steel
Dimensions	
Sensor sleeve	Diameter: 4 mm, length: 50 mm
Connecting cable	Length: 1 000 mm
Article-No.	29-20050

Optional Accessories

Article-No.	Type	Description
29-20051	EM-PT100 MF	Mounting flange for the temperature probe

Cost Allocation / Cost Centre Acquisition

Acquisition of Process Data

3



Cost Allocation / Cost Centre Acquisition

Acquisition of Process Data



3

EM-AM 2108 Analogue Module

Data acquisition system for 8 analogue, freely configurable input channels. This allows to detect and visualize sensors with random output signals with the FRAKO Energy Management System.

Description

- 8 analogue inputs, selectively:
 - Temperature -50 °C up to 150 °C via 5 K NTC
 - 0 / 4 to 20 mA or - 0 to 10 V
- Monitoring of temperatures and analogue signals with upper and lower alarm limit
- External supply voltage 9 to 36 V DC
- Connection via FRAKO Starkstrombus
- Resolution temperature range: 0.1 °C; Accuracy entire temperature range: 1 °C
- Resolution voltage range: 10 mV; max. failure: 30 mV
- Resolution current range: 20 µA; max. failure: 60 µA
- Easy configuration of the EM-AM 2108 via EM-AM-SW software
- For each input of the analogue module the current measurement readings as well as the maximum and the minimum value of the last interval will be displayed by the EM-AM SW software
- By integrating the EM-AM 2108 into the FRAKO Energy Information System all temperatures and analogue signals will be captured and monitored with their upper and lower alarm limits
- The system visualization software EMVIS 3000 allows to analyse and visualize the data

Cost Allocation / Cost Centre Acquisition

Acquisition of Process Data

Technical Data

Power Supply	
Mains voltage	9 up to 36 V DC
Power consumption	0.72 VA
Input	
Input variable	Direct current or direct current voltage
Rated value	0 to 20 mA, 4 to 20 mA, $R_i = 130 \text{ Ohm}$, 0 to 10V, $R_i = 115,13 \text{ kOhm}$
Overload, constant	2.5 times (current), 2.5 times (voltage)
Short-time overload	5 times 1 s (current), 5 times 1 s (voltage)
Temperature measurement	Range: -50 °C up to 150 °C Resolution: approx. 0.1 °C Accuracy: 1.5 °C (-50 °C up to -25 °C); 1.0 °C (-25 °C up to +100 °C); 2.0 °C (+100 °C up to +125 °C); 3.5 °C (+125 °C up to +150 °C)
Current measurement	Range: 0 to 20 mA; 4 to 20 mA Resolution: 20 µA; max. failure: 60 µA
Voltage measurement	Range: 0 to 10 V Resolution: 10 mV; max. failure: 30 mV
Connections	Screw terminals; Wire cross section: max. 1.4 mm ²
Interface	
1 FRAKO Starkstrombus	For connection to FRAKO Energy Management System, according to EN 50170 (P-Net), standardised fieldbus, RS-485 transfer rate: 76.8 kbit/s
Display elements	2 LEDs
Mechanical construction	
Dimensions	86 x 128 x 50 mm (W x H x D)
Ingress protection	Housing/terminals IP30/IP20 according to DIN EN 60529
Version	Housing insulated, protection class 3 (SELV), at a rated voltage up to max. 36 V, pollution degree 2, according to EN 61010 part 1 EMV according to EN 61326-1
Installation	On standard rail 35 mm according to DIN EN 50022
Weight	190 g
Operating conditions	
Ambient temperature	0 °C up to +70 °C
Article-No.	20-40009

Optional Accessories

Article-No.	Type	Description
20-10700	Power Supply for analogue module EM-AM 24V DC	AC/DC SMPS adapter, DIN rail-mounted, 24 V DC / 0.35 A and 12 V DC / 20 mA, AC power supply 85 to 264 V (also suitable for EM-PQ 1500)

Cost Allocation / Cost Centre Acquisition

Acquisition of Process Data



Software

Visualization Software

Page 267

Software for Cost Centre Analysis

Page 271

EMG-OPC-Server

Page 273

System visualization is **INCLUDED** if a PQM 1588 with system points is purchased!



suitable for evaluations according to EN 50001

EMVIS 3000 System-Visualization

In the Energy Management System, the measured variables, statuses and events in the entire in-house energy supply system are acquired, processed centrally and saved. They are presented graphically by the visualization facility and evaluated. The EMVIS 3000 software is a powerful tool for displaying and documenting all the measurement readings from the devices connected to the system. A client management function is available, which enables individual organizational system trees to be assigned to different users, who therefore receive exactly those data that they require for their separate purposes. There are two types of installation: either the single workstation or the server version, the latter with access to up to 5 clients simultaneously via a web browser, with no additional installation necessary in the client systems.

EMVIS 3000 comprises the following functional modules:

EMVIS 3000 Project

The project planning tool ...

- Unrestricted configuration and compilation of evaluations of all data processed by the system
- New functions such as alarm visualization, status, history, ranking
- Server version with access via browser
- User administration, the administrator defines user rights and accesses
- Calculation of **performance figures**
Performance figures are virtual data points calculated from other data points, an arithmetic computation from measured or imported data, e.g.: "Active energy A x factor + Water quantity B x factor + Compressed air volume C x factor / No. of items D"
- Creation of **benchmarking** charts
Benchmarking makes a direct comparison of measurement data or performance figures possible, e.g. energy costs of products or company sites
- Creation of **Sankey** diagrams
A Sankey diagram gives a clear overview of any type of flow, e.g. the flow of utilities. The width of each stream into and out

of a location is proportional to the quantity flowing, absolute and percentage values also being stated

- Easy Customizing - individual planning of views - simple and intuitive (the basic package includes 3 views with up to 20 online data points in total)

EMVIS 3000 Report

The reporting tool ...

- To simplify navigation, a clear overview of the entire system is displayed in two system trees, either of which can be selected:
 - **Physical:** standard evaluations of all the instruments and channels registered with the system
 - **Organizational:** all evaluations that have been compiled with EMVIS 3000 Project
- Presentation of historical data for analysis and comparison purposes, e.g. different locations or different periods of time
- For example diagrams showing the time course or diagrams without timeline such as **carpetplot, scatter diagram and heatmap**
- The historical data can be exported directly from the chart or consumption table for further processing. Possible export formats are CSV, Excel, Word and PDF
- Direct access to the momentary readings of the connected instruments

Software

Visualization Software

- Visualization of the alarms occurred is possible through display of the status, history and statistical evaluation in the ranking

EMVIS 3000 Live

- Views created individually - from site layout drawings right down to the distribution board
 - Display of the momentary measurement readings and statuses
- The EMVIS 3000 license enables the software to be installed on several PCs (server and clients). It allows access to the Power Quality Manager PQM 1588 and the Central Unit EMIS1500.

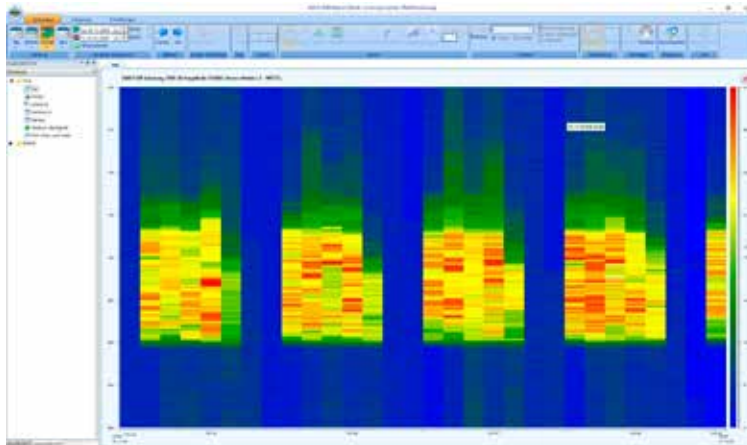

Carpetplot

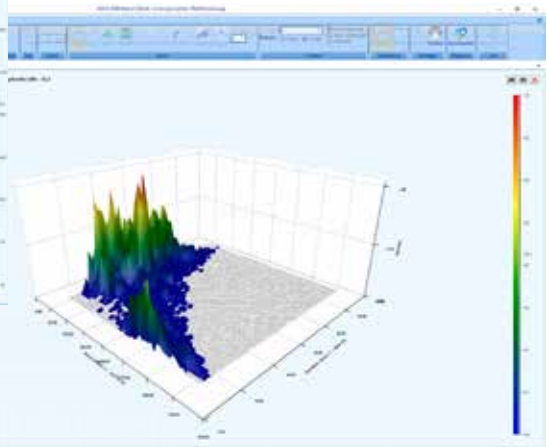

Heatmap 3-D

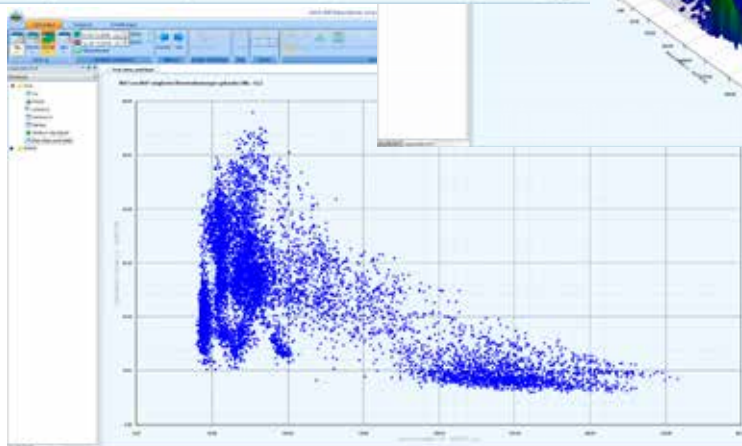

Scatter diagram 2-D



In the physical system tree prepared standard evaluations are deposited for all Energy Management devices. This allows the user to visualize the recorded historical data.

Software

Visualization Software

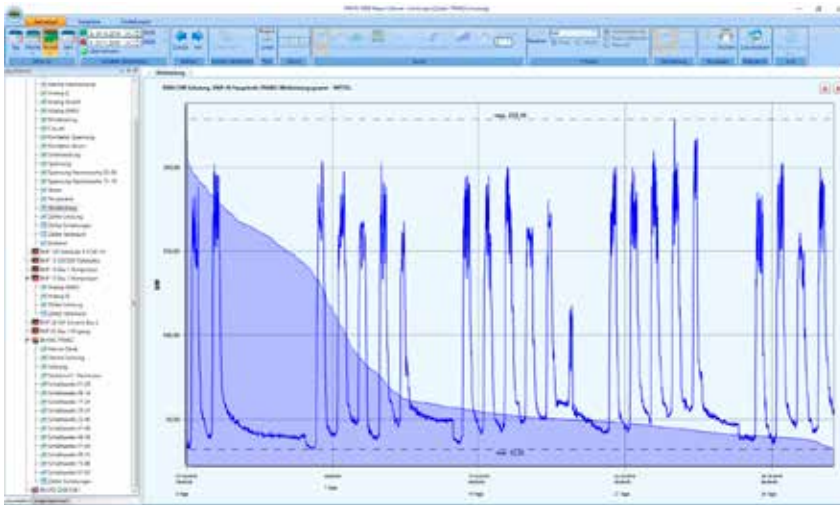

Continuous line graphic - shows the frequency of the variables within a period of time

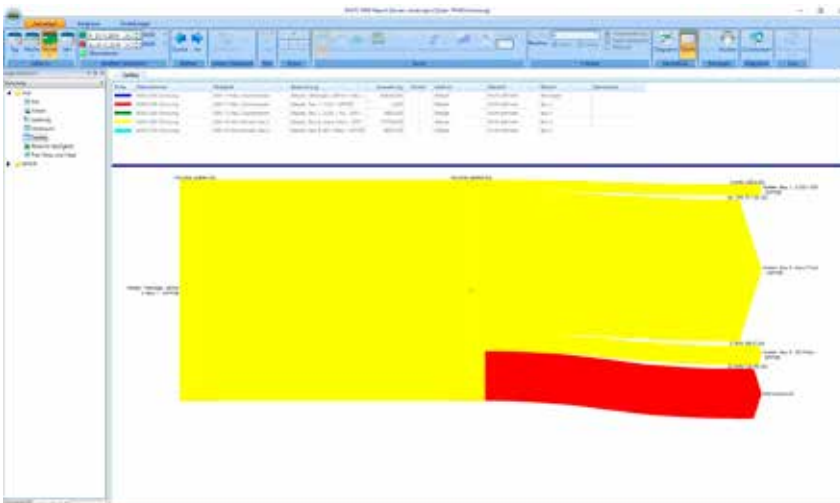

Sankey graphic - shows the flow of energy

The screenshot shows a software window with a toolbar and a sidebar on the left. The main area displays a table for user administration authorization. The table has columns for 'Berechtigung', 'FRAKO/Schulung', 'SCHULUNGSRV/User1', and 'SCHULUNGSRV/User2'. The rows are 'Freigelesen', 'Phys. SB', 'OrgSystembaum', and 'Schulung'.

Berechtigung	FRAKO/Schulung	SCHULUNGSRV/User1	SCHULUNGSRV/User2
Freigelesen	<input type="checkbox"/>	<input type="checkbox"/>	<input type="checkbox"/>
Phys. SB	<input checked="" type="checkbox"/>	<input checked="" type="checkbox"/>	<input type="checkbox"/>
OrgSystembaum	<input checked="" type="checkbox"/>	<input checked="" type="checkbox"/>	<input checked="" type="checkbox"/>
Schulung	<input checked="" type="checkbox"/>	<input type="checkbox"/>	<input type="checkbox"/>

Authorization graphic - table showing user administration authorization



Standard evaluations for each energy management device are stored in the physical system tree, enabling the user to visualize the recorded and momentary measurement data without the need for individual configuration.

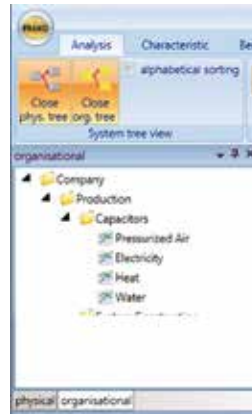

Within the organizational system tree business specific structures are deposited. The business specific structures are projected in form of individual evaluation in the organizational system tree by the customer.

Technical Data

PC requirements for small and medium systems	
Hardware	<ul style="list-style-type: none"> • Min. Intel Core I3-Processor • User memory: 4 GB RAM • 1 GB free hard disk space • Graphics adapter: min. DirectX 9.0c support and 512 MB video memory
Software	<ul style="list-style-type: none"> • Microsoft® Windows®* 7 • Microsoft® Windows®* 8 • Microsoft® Windows®* 10 • Microsoft® Windows®* Server 2008 R2 • Microsoft® Windows®* Server 2012 R2 • Microsoft® Windows®* Server 2016 • Microsoft® .NET Framework 3.5 • Microsoft® .NET Framework 4.5 • FRAKO-NET (min. V1.40.0056 or higher) • Firebird V2.5.0 (included in FRAKO-NET) <p>* Registered trademark of Microsoft Corporation</p> <p>Please note: the server variant will only work with a 64-bit system</p>
Article-No.	20-10649

EMVIS 3000 Extension packages

Article-No.	Type	Description
20-10650	EasyCustomizing-S	Individually designed views with up to 100 data points
20-10651	EasyCustomizing-M	Individually designed views with up to 200 data points
20-10652	EasyCustomizing-L	Individually designed views with up to 350 data points
20-10653	EasyCustomizing-XL	Individually designed views with up to 550 data points
20-10654	EasyCustomizing-XXL	Individually designed views with up to 1000 data points

EMVIS 3000 Software-Update

Article-No.	Type	Description
20-10555	EMVIS 3000 Software-Update	from version 3.0 to the latest version up to V3.XXX

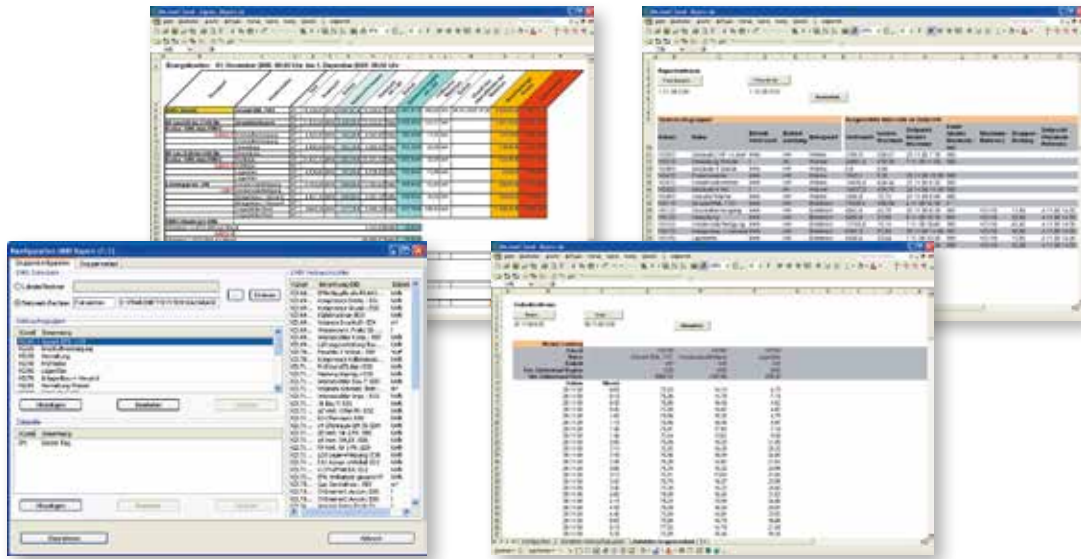

EMIS[®] Report Software for Cost Centre Analysis

Energy analysis with EMIS[®] Report.

Software for automated analysis of energy consumption based on Microsoft[®] Excel*.

The consumption data recorded with the FRAKO Energy Management System can be imported to an Excel workbook from the SQL databases FRAKO-NET or FRAKO EMIS-DB.

The reporting period can be set as required.

Individual loads or metering units can be combined to load groups (e.g. cost centres) and evaluated with different time profiles.

Customer-specific reports can easily be generated by linking to appropriate cells.

By means of that you achieve an optimum transparency of the energy flows within the company.

With EMIS[®] report, data from the FRAKO database can be imported to an Excel sheet and are available for a customer specific analysis.

This makes it a very useful tool for the allocation of costs of the different company divisions and/or energy transfer media (electricity, gas, oil, etc.). It is also a useful data source for the financial controlling of a company.

Transparency of energy costs

- Assigning costs to the originators
- Transparency of all energy flows within the company
- Achieve the utmost efficiency
- Automatic evaluation through e-mail notification - also available as CSV-file

To achieve an optimized reduction of the energy costs it is essential to have information on how much energy was consumed when and where.

The knowledge of the energy consumption per cost centre is necessary to determine the potential for savings.

EMIS[®] Report provides a structured overview of the consumption of all types of energy of your company such as current, water, gas, compressed air etc. This enables you to financially evaluate those consumptions.

Individual loads or metering units can be combined into load groups or cost centres and evaluated according to different time schedules.

Software

Software for Cost Centre Analysis

Thus, optimal transparency of energy flows is achieved in the company.

Functions:

- Automatic evaluation and notification by e-mail
- Period covered by the report is freely definable (date, day, etc.)
- Determination of consumption (kWh, l, m³, ...)
- Consumption peaks within the reporting period
- Time of maximum demand (e.g. kWh)
- Demand by a load or a load group at the time of peak consumption of a reference unit
- Interval values (e. g. 15 minutes) of the reporting period for consumption or consumption rate (e.g. kW)
- Sum of the interval values of the reporting period
- Evaluation according to different time profiles

Technical Data

PC requirements	
Hardware	<ul style="list-style-type: none">• Pentium, min. 2 GHz clock frequency• User memory: min. 1 GB RAM• 6 GB free hard disk space• Ethernet 10/100 Mbit/s network connection or/and one free serial interface• CD-ROM drive• SVGA graphics adapter• Colour screen, minimum resolution: 1024 x 768 Pixel
Software	<ul style="list-style-type: none">• Microsoft® Windows®* 7• Microsoft® Windows®* 8• Microsoft® Windows®* 10• Microsoft® Windows®* Server 2008 R2• Microsoft® Windows®* Server 2012 R2• Microsoft® Windows®* Server 2016• Microsoft® Excel* (from version 2000)• FRAKO-NET database <p>* Registered trademark of Microsoft Corporation</p>
Article-No.	20-10488

Optional Accessories

Article-No.	Type	Description
20-10494	Software expansion for EMIS® Report	Software update for cost centre and analysis software EMIS® Report

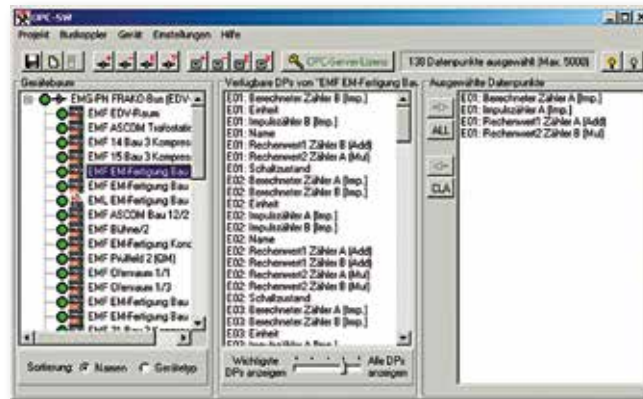

EMG-OPC-Server

Software interface with the current OPC server.

OPC is an open software interface standard that enables a simple standardized interchange of data to take place between automation and control applications, SCADA systems (process visualization) and office applications (e.g. Microsoft® Excel*, Access*).

FRAKO EMG-OPC Server has been developed for visualization purposes on the basis of the **OPC Data Access Specifications 1.0, 2.0 and 3.0**, and uses the Microsoft® DCOM standard.

This enables the client and server to be separated at various PCs in a network. It is recommended, however, to use client and server on the same PC.

Benefits of the OPC interface

- Easy linking of FRAKO measurement devices, provided with the FRAKO Starkstrombus protocol, to PC software such as visualization systems or office applications
- Data interchange between applications from various suppliers through a common interface

Operating principle

OPC works on the **client / server principle**. **EMG OPC Server** 'serves up' data from the FRAKO measurement devices, provided with the FRAKO Starkstrombus protocol, i.e. makes these available externally. The PC application as 'client' receives and processes the data.

Communication with the **FRAKO Starkstrombus** is via PQM 1588 or the internal gateway in the EMIS® 1500. Access to the gateways is via the site's own Ethernet network (TCP / IP).

The **OPC-SW** software creates the configuration files, which contain the data points for the namespace. This supplies a preselection of data points per gateway that can be provided by **EMG-OPC-Server**. These configuration files are loaded when **EMG-OPC-Server** is started. The OPC client then selects the data points to be provided by EMG-OPC-Server from the specified namespace.

Up to 8 PQM 1588 gateways or internal gateways of the EMIS® 1500 and a maximum number of 5000 data points can be registered per **EMG-OPC-Server**. The same system requirements apply as for the **FRAKO EMVIS 3000 visualization system**.

Configuration

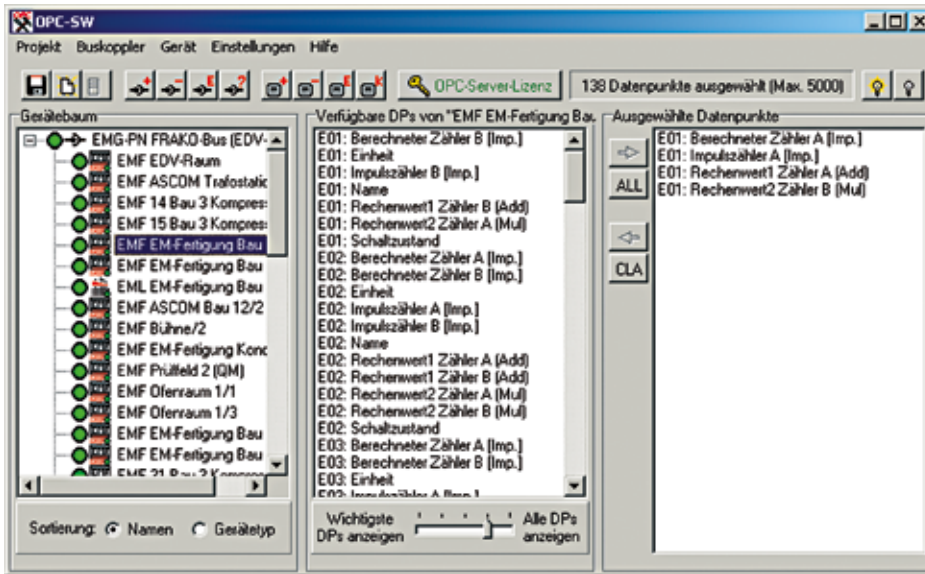

Technical Data

PC requirements	
Hardware	<ul style="list-style-type: none"> • 2 GHz Dual-Core processor • User memory: 2 GB RAM • 1 GB free hard disk sapce • Ethernet 10/100 Mbit/s network connection
Software	<ul style="list-style-type: none"> • Microsoft® Windows®* 7 • Microsoft® Windows®* 8 • Microsoft® Windows®* 10 • Microsoft® Windows®* Server 2008 R2 • Microsoft® Windows®* Server 2012 R2 • Microsoft® .NET Framework 1.1 • Microsoft® .NET Framework 4.0 <p>* Registered trademark of Microsoft Corporation</p>
Article-No.	20-10491

A

- Accessory equipment for PFC Systems on mounting plates 87
- Active Filters
 - OSF EZ-Series 169
 - OSFS 183
- Analogue Module
 - EM-AM 2108 263

C

- Capacitor Modules
 - C64C / C84C 77
- Capacitor Modules – detuned
 - C64D-P / C84D-P / C65D-P / C85D-P 81
- Capacitor Switching Contactors
 - K3-...K... / K3-...A 45
- Cost Centre and Alarm Unit
 - EMF 1102 257

D

- Discharge Reactors
 - FR 3AC 49
- Display Units
 - EM-FD 1500 213
 - EM-FD 2500 211
- Dynamic Power Factor Correction Systems
 - C84D-P-E / C85D-P-E / C86D-P-E ... 159
 - LSFC-E 155

E

- Electronic Energy Meter
 - M3PRO 80 MID / M-Bus / ModBus, M3PRO 1-5 MID / M-Bus / ModBus and IME Conto D4 251
- EMG-OPC-Server 273

F

- Frequency-Converter
 - EM-UIF / EM-PTF 259

H

- Harmonic Filter Reactors Basic
 - FDKT 23
- Harmonic Filter Reactors Standard
 - FDR / FKD 27

M

- Mains Analysis Devices for DIN rail mounting
 - EM-PQ 1500 M 203
 - EM-PQ 2300 197
- Mains Monitoring Instruments for door mounting
 - PQA 1101 207
- Maximum Controller
 - EM-MC 2200 241
- MCS – Modular Construction System
 - MCS 133

P

- Passive Filter Systems in sheet steel cabinets
 - LSFC-P4 163
- Power Capacitors
 - LKT 9
- Power Factor Control Relays
 - RM 2106 / RM 2112 / PFC-12TR-1 / PFC-12TR-1-RS485 35
 - Power Factor Control Relays PQC 39
- Power Factor Correction Capacitors in sheet steel cases
 - LKN / LKSLT 55
- Power Factor Correction Capacitors in sheet steel cases – detuned
 - LKND-P / LKNS-P 61
- Power Factor Correction Systems
 - LSFC 109
 - LSK / LSK1 103
- Power Factor Correction Systems – detuned
 - LSFC-P 123
 - LSK-P 117
- Power Factor Correction Systems on mounting plates
 - LSPN / LSP 69
- Power Factor Correction Systems on mounting plates – detuned
 - LSP-P 73
- Power Quality Manager, Central Unit for data acquisition
 - PQM 1588 215, 231

R

- Repeater
 - EMB 1101 237

S

- Software for Cost Centre Analysis
 - EMIS® Report 271
- Switching Module
 - EMD 1101 247

T

- Technical Annex
 - Guide to selection: Harmonic Filter Reactors → Capacitors 139
 - Supply lead cross sections 137
- Temperature Sensor
 - EM-PT 100 261

V

- Visualization Software
 - EMVIS 3000 219, 267



FRAKO Kondensatoren- und Anlagenbau GmbH
Tscheulinstraße 21a
79331 Teningen, Germany
Phone: +49 7641 453-0
Fax: +49 7641 453-535
sales@frako.com
www.frako.com